

Evaluation Board and Circuit

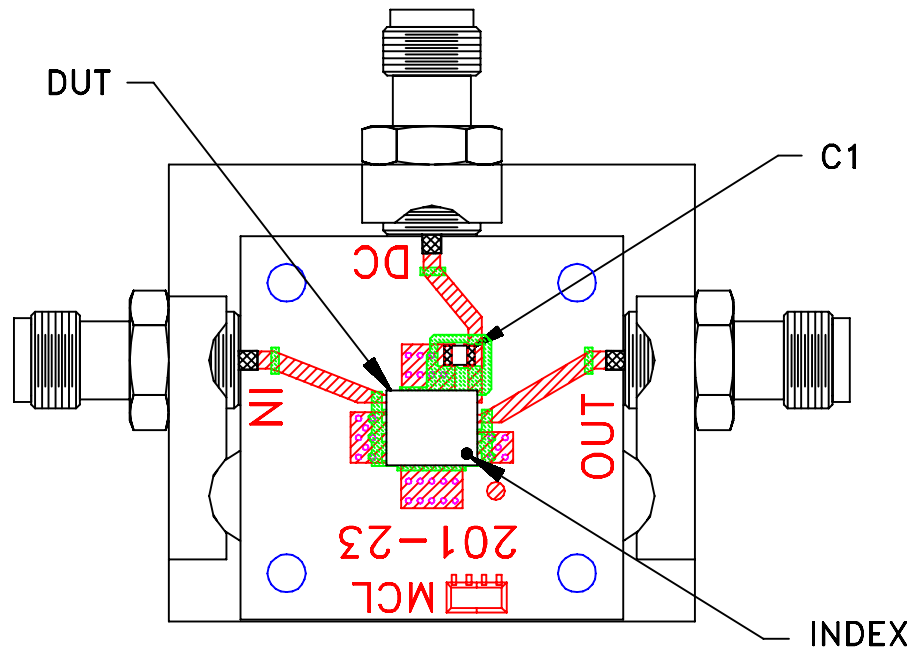

TB-616-2+

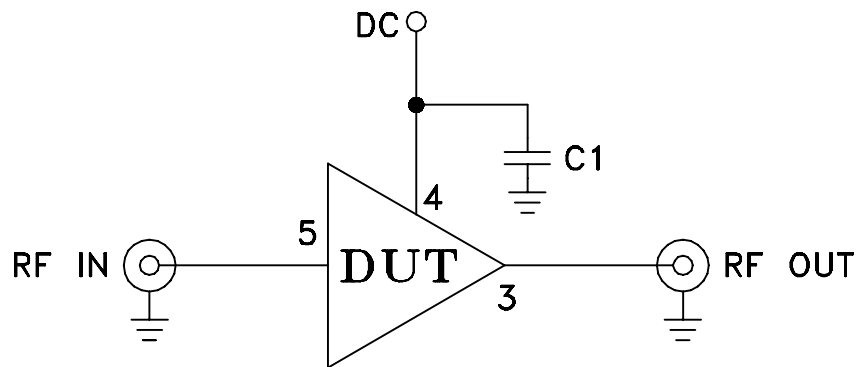

COMPONENT	VALUE
DUT	YSF-122+
C1	1000 pF

Schematic Diagram

Notes:

1. 50 Ohm SMA Female connectors.
2. PCB Material: R04350 or equivalent,
Dielectric Constant=3.5, Thickness=.020 inch.

 **Mini-Circuits®**