

Evaluation Board and Circuit

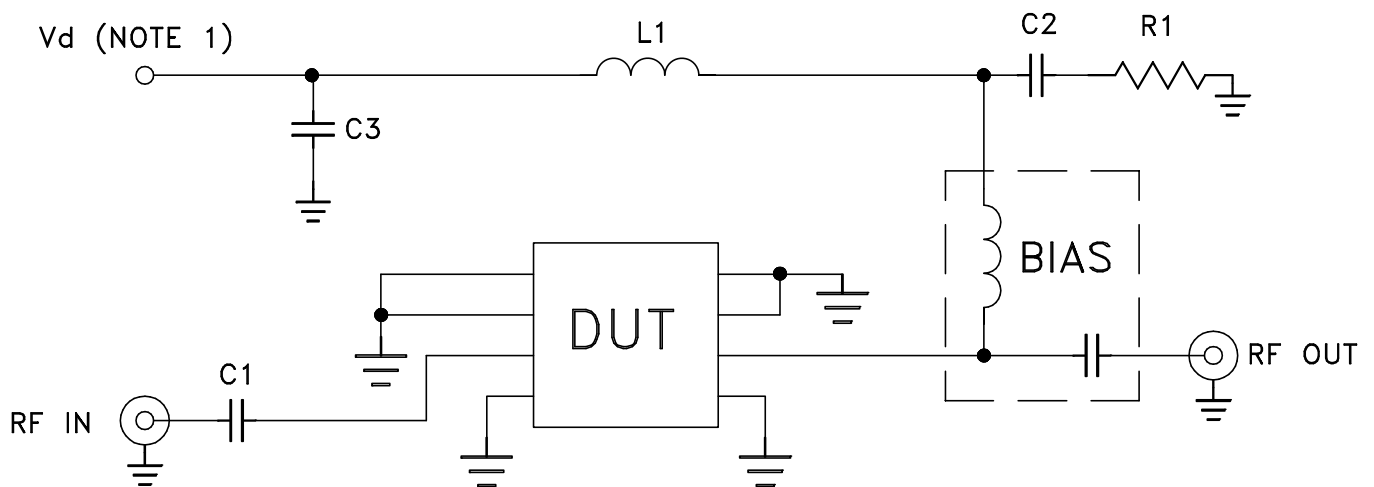
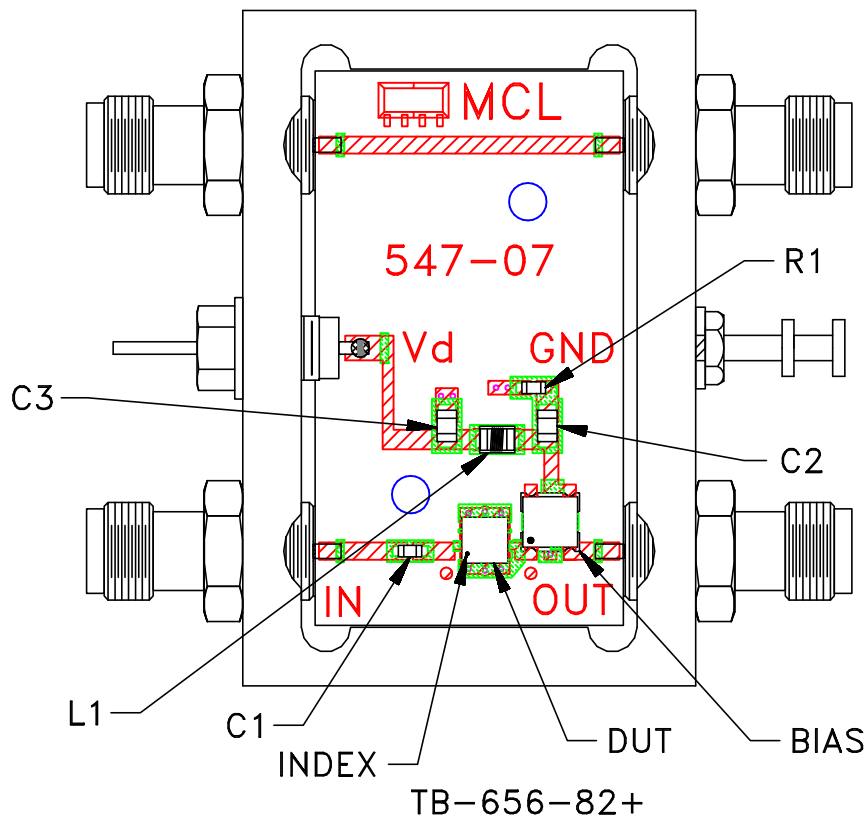

COMPONENT	DESCRIPTION
DUT	CMA-82+
C1	.01 uF
C2,C3	.1 uF
L1	15 nH
R1	11.5 Ohm
BIAS TEE	Mini-Circuits TCBT-14+

Schematic Diagram

NOTES:

1. Vd voltage: +5V.
2. SMA Female connectors.
3. PCB material: Rogers R04350 or equivalent, dielectric constant=3.5, dielectric thickness=.020 inch.

 **Mini-Circuits®**