

# Evaluation Board and Circuit

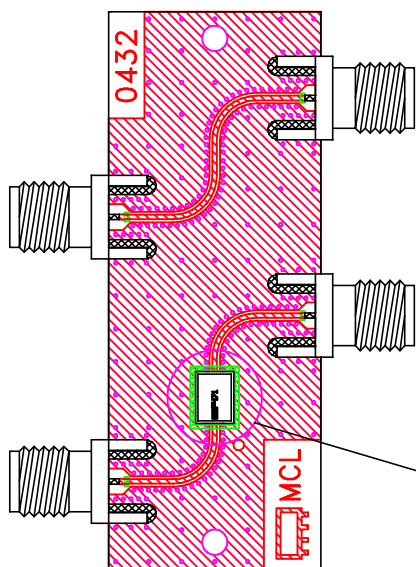

TB-BFHKI-1982C+

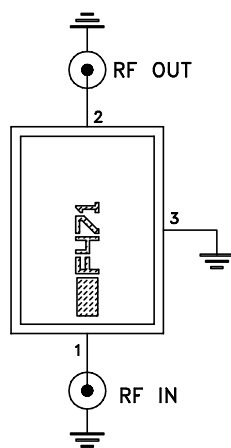
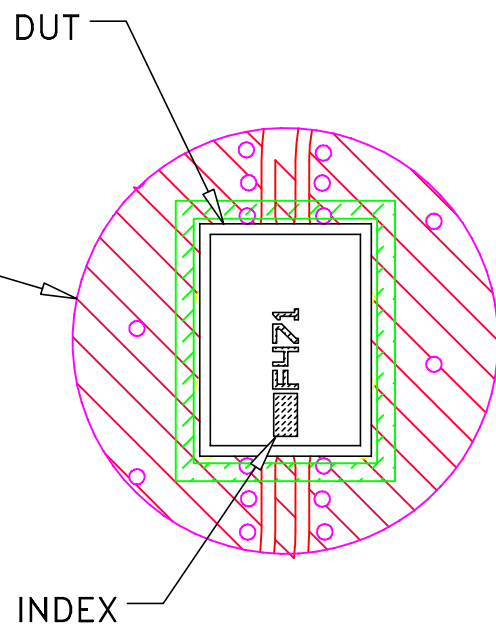

Schematic Diagram

## Notes:

1. SMA Female connectors.
2. PCB Material: Rogers R04350 or equivalent, Dielectric Constant=3.5, Thickness=.010 inch.

 **Mini-Circuits®**