



CERAMIC

Bandpass Filter

BFHK-1982+

50Ω 17.5 to 22.2 GHz

THE BIG DEAL

- Ultra-High Stopband Rejection Structure – 80 dB typical
- Surface mountable pick and place standard case style
- Standard small 1812 (4.5mm x 3.2mm) case style
- High quality distributed filter topology
- Wide rejection band
- Shielded construction preventing filter from de-tuning
- Reduced footprint area by employing LGA (land grid array)
- Suited for very high-volume production
- Patent Pending



Generic photo used for illustration purposes only

CASE STYLE: NM1812C-3

+RoHS Compliant

The +Suffix identifies RoHS Compliance. See our web site for RoHS Compliance methodologies and qualifications

APPLICATIONS

- Test and Measurement
- Aerospace and Defense Signal Conditioning

PRODUCT OVERVIEW

The BFHK-1982+ LTCC Band Pass Filter achieves a miniature size and high repeatability of performance by utilizing a proprietary LTCC material system and distributed filter topology. The passband loss at 17.5 – 22.2 GHz is as low as 2.8 dB, with typical stopband rejections at 80 dB up to 39 GHz and 55 dB up to 53 GHz. This model handles up to 1W RF input power, and provides a wide operating temperature range from -55 to +125°C. Utilizing a proprietary LTCC material system and a distributed filter topology, this filter is able to achieve repeatable performance on a lot-to-lot basis.

KEY FEATURES

Feature	Advantages
Ultra-High Rejection	Typical stopband rejections at 80 dB up to 39 GHz and 60 dB up to 53 GHz
Cost effective	LTCC is scalable technology that is cost effective due to ease of production in high quantities.
Small size (4.5mm x 3.2mm)	Allows for high layout density of circuit boards, while minimizing effects of parasitics.
Surface Mountable	Suitable for very high volume automated assembly process.

REV. OR
ECO-013325
BFHK-1982+
CGD/CP/AM
220520





CERAMIC

Bandpass Filter

BFHK-1982+

ELECTRICAL SPECIFICATIONS¹ AT 25°C

Parameter	F#	Frequency (GHz)		Min.	Typ.	Max.	Units	
Center Frequency	—	—	—	—	19.7	—	GHz	
Pass Band	Insertion Loss	F1-F2	17.5	22.2	—	2.8	4.0	dB
	Return Loss	F1-F2	17.5	22.2	—	12.0	—	dB
Stop Band, Lower	Insertion Loss	DC-F3	0.1	12.6	70	80	—	dB
Stop Band, Upper	Insertion Loss	F4-F5	27.5	39	70	80	—	dB
			39	53	40	55.0	—	

1. Measured on Mini-Circuits Test Board TB-BFHK-1982C+ with connectors and feedlines de-embedded.

MAXIMUM RATINGS

Parameter	Ratings
Operating Temperature	-55°C to 125°C
Storage Temperature	-55°C to 125°C
RF Power Input	1W max.

Permanent damage may occur if any of these limits are exceeded

TYPICAL FREQUENCY RESPONSE

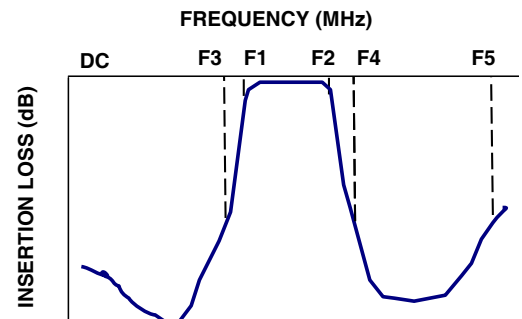

FUNCTIONAL SCHEMATIC

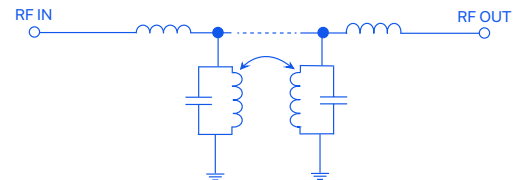



CERAMIC

Bandpass Filter

BFHK-1982+

EVALUATION BOARD MCL P/N: TB-BFHK-1982C+
SUGGESTED PCB LAYOUT: PL-730

TOP VIEW

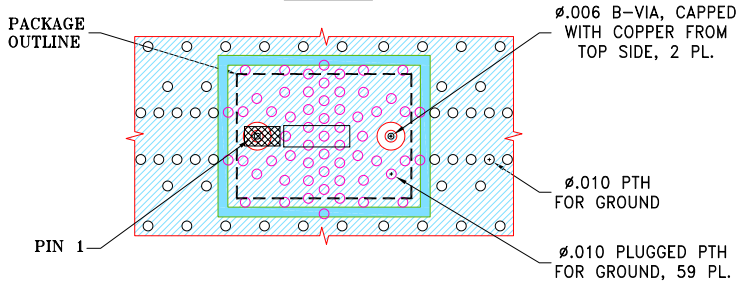

STACK-UP DIAGRAM

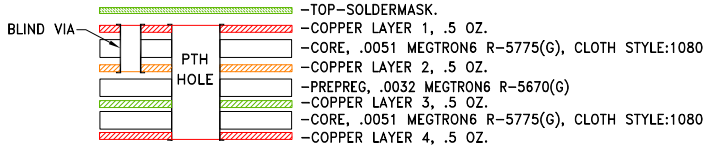

1. TOTAL FINISHED THICKNESS $0.019 \pm 10\%$.
2. B-VIA PRESENT FROM COPPER LAYER 1 TO COPPER LAYER 2.
3. PTH PRESENT FROM COPPER LAYER 1 TO COPPER LAYER 4.
4. INDICATED PLUGGED PTH'S ARE PLUGGED WITH EPOXY AND CAPPED WITH COPPER FROM TOP SIDE.
5. LAYER 4 IS CONTINUOUS GROUND PLANE.

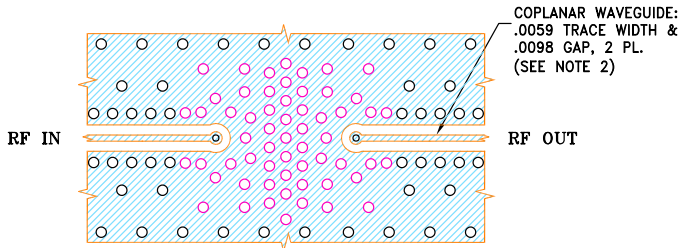

LAYER 3 & PTH

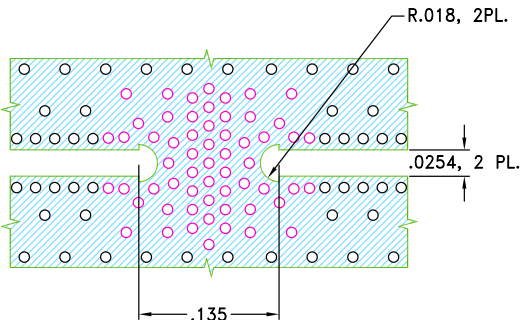

PAD CONNECTIONS

INPUT	1
OUTPUT	2
GROUND	3

PRODUCT MARKING: F471

OUTLINE DRAWING

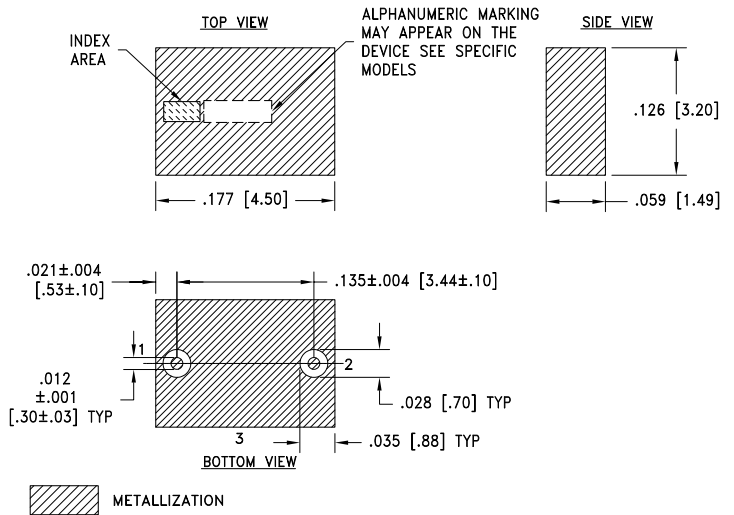

Weight: .126 grams.

Dimensions are in inches [mm]. Tolerances: 2Pl.±.01; 3Pl. ±.005



CERAMIC

Bandpass Filter

BFHK-1982+

TYPICAL PERFORMANCE DATA

Frequency (MHz)	Insertion Loss (dB)	Return Loss (dB)
25	108.13	0.09
100	112.72	0.10
1000	109.53	0.21
2000	112.97	0.05
3000	110.48	0.03
4000	118.78	0.13
6000	131.18	0.33
7000	110.62	0.25
8000	124.32	0.19
10000	106.09	0.22
11000	100.63	0.26
12000	93.08	0.31
12600	86.54	0.43
14000	66.61	0.69
17500	1.58	18.26
19750	1.61	16.88
22200	1.90	28.36
27500	93.61	0.50
39000	90.57	0.69
40000	90.11	0.33
53000	73.87	1.19

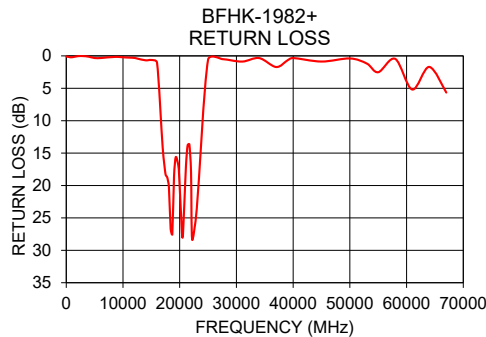
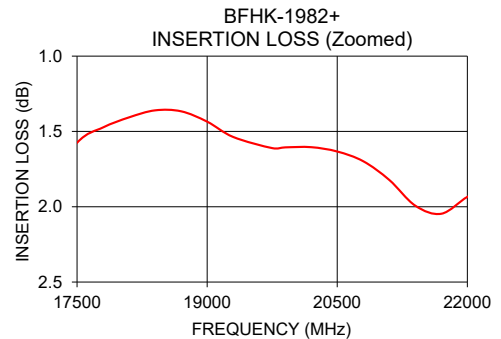
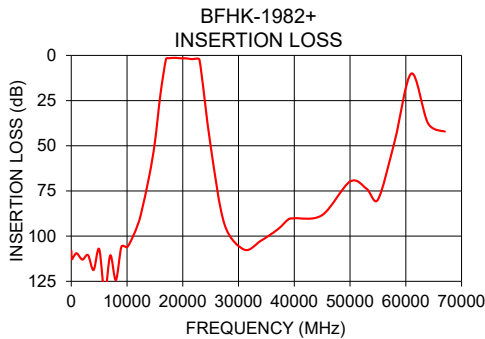

- NOTES**
- A. Performance and quality attributes and conditions not expressly stated in this specification document are intended to be excluded and do not form a part of this specification document.
 - B. Electrical specifications and performance data contained in this specification document are based on Mini-Circuit's applicable established test performance criteria and measurement instructions.
 - C. The parts covered by this specification document are subject to Mini-Circuits standard limited warranty and terms and conditions (collectively, "Standard Terms"); Purchasers of this part are entitled to the rights and benefits contained therein. For a full statement of the standard. Terms and the exclusive rights and remedies thereunder, please visit Mini-Circuits' website at www.minicircuits.com/terms/viewterm.html

