

Ceramic Bandpass Filter

BFHK-2582+

50Ω 24.25 to 27.50 GHz

The Big Deal

- 5G n258 bandpass filter
- Low Insertion Loss – Mid band 2.0dB typical
- Pick and place standard case style
- Small size 4.5mm x 3.2mm
- High quality distributed filter topology



CASE STYLE: NM1812C-2

Product Overview

The BFHK-2582+ LTCC Bandpass Filter covers the 5G n258 band. This corresponds to a passband of 24.25 to 27.5 GHz, with as low as 2dB passband loss, and up to 58dB stopband rejection. This model handles up to 1W RF input power and provides a wide operating temperature range from -55 to +125°C. Utilizing a proprietary LTCC material system and a distributed filter topology, this filter is able to achieve repeatable performance on a lot to lot basis, up to mmWave frequencies.

Key Features

Feature	Advantages
5G n258 band	Designed for 5G Telecommunications, n258 band, 24.25 - 27.50 GHz
Proprietary mmWave compatible LTCC material system	Low loss and repeatable performance on a lot to lot basis up to mmWave frequencies.
Cost effective	LTCC is scalable technology that is cost effective due to ease of production in high quantities.
Small size (4.5mm x 3.2mm)	Allows for high layout density of circuit boards, while minimizing effects of parasitics.



Ceramic Bandpass Filter

50Ω 24.25 to 27.50 GHz

Features

- Small size
- Temperature stable
- Hermetically sealed
- LTCC construction

Applications

- 5G Telecommunications

BFHK-2582+



Generic photo used for illustration purposes only

CASE STYLE: NM1812C-2

+RoHS Compliant

The +Suffix identifies RoHS Compliance. See our web site for RoHS Compliance methodologies and qualifications

Available Tape and Reel at no extra cost

Reel Size	Devices/Reel
7"	20, 50, 100, 200, 500, 1000, 3000

Maximum Ratings

Operating Temperature	-55°C to +125°C
Storage Temperature	-55°C to +125°C
RF Power Input	1W at 25°C

Permanent damage may occur if any of these limits are exceeded.

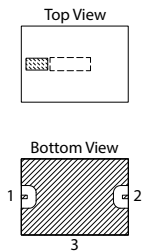

Pad Connections

Input	1
Output	2
Ground	3

Functional Schematic

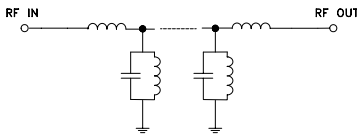

Electrical Specifications¹ at 25°C

Parameter	F#	Frequency (GHz)	Min.	Typ.	Max.	Unit
Center Frequency	—			25.8		MHz
Pass Band	Insertion Loss	F1-F2	24.25 - 24.56	—	4	—
			24.56 - 26.45	—	2	4.5
			26.45 - 27.5	—	4	—
	Return Loss	F1-F2	24.25 - 27.5	—	10	—
Stop Band, Lower	Insertion Loss	DC - 9	45	58	—	—
			9 - 21	34	40	—
			21 - 21.7	—	40	—
Stop Band, Upper	Insertion Loss	F4-F5	29.43 - 33	—	30	—
			33 - 35.4	21	30	—
			35.4 - 46	—	25	—

1. Measured on Mini-Circuits Characterization Test Board TB-BFHK-2582C+ with feedline losses removed by normalization of S12 and S21 traces to measurement of TB thru-line.

Typical Performance Data at 25°C

Frequency (GHz)	Insertion Loss (dB)	Return Loss (dB)
1	76.49	0.38
5	63.57	1.12
10	56.27	1.26
15	47.15	1.51
20	39.84	1.86
23	14.86	2.70
24	2.32	12.94
25	1.46	26.07
26	1.64	14.78
27	2.54	11.86
28	8.70	5.33
30	38.18	2.42
35	40.95	2.58
40	39.07	2.56
45	41.01	2.57
50	10.66	4.74

Specification Definition

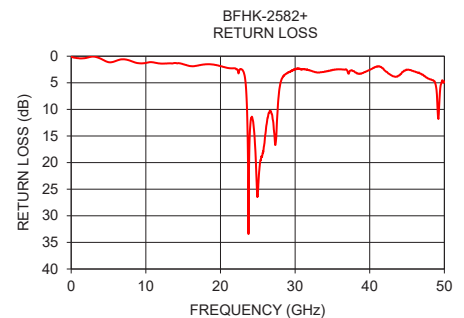
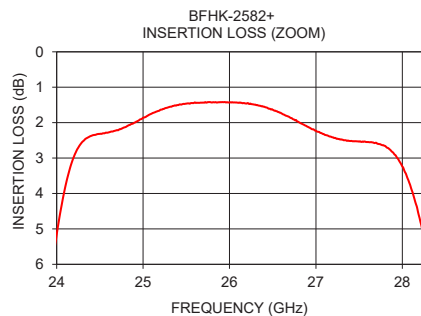
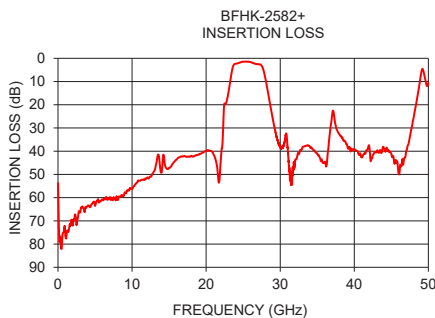
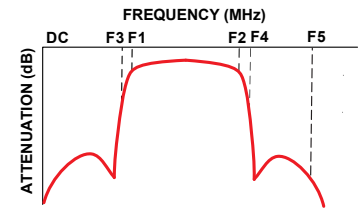

Bandpass Filter

BFHK-2582+

Outline Drawing

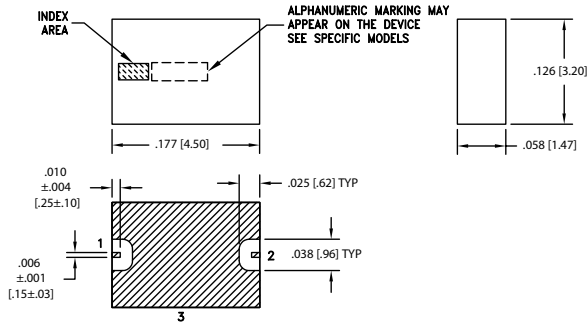

METALLIZATION

Weight: .064 grams.
Dimensions are in inches [mm]

Product Marking: F415

Pad Connections

Input	1
Output	2
Ground	3

Demo Board MCL P/N: TB-BFHK-2582C+ Suggested PCB Layout (PL-677)

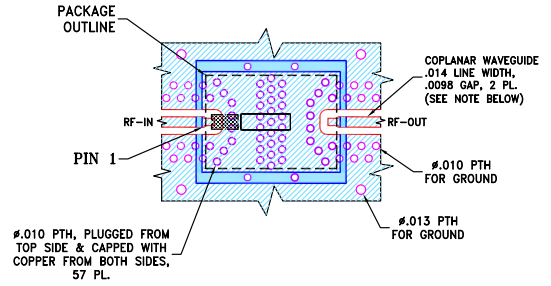

NOTES:

- TRACE WIDTH AND GAP ARE SHOWN FOR MEGTRON7 WITH DIELECTRIC THICKNESS: .0079±.001"; COPPER: HVLP/HVLP. FOR OTHER MATERIALS TRACE WIDTH AND GAP MAY NEED TO BE MODIFIED.
- BOTTOM SIDE OF THE PCB IS CONTINUOUS GROUND PLANE.

- DENOTES PCB COPPER LAYOUT WITH SMOBC (SOLDER MASK OVER BARE COPPER).
- DENOTES COPPER LAND PATTERN FREE OF SOLDER MASK.

Additional Notes

- Performance and quality attributes and conditions not expressly stated in this specification document are intended to be excluded and do not form a part of this specification document.
- Electrical specifications and performance data contained in this specification document are based on Mini-Circuit's applicable established test performance criteria and measurement instructions.
- The parts covered by this specification document are subject to Mini-Circuits standard limited warranty and terms and conditions (collectively, "Standard Terms"); Purchasers of this part are entitled to the rights and benefits contained therein. For a full statement of the Standard Terms and the exclusive rights and remedies thereunder, please visit Mini-Circuits' website at www.minicircuits.com/MCLStore/terms.jsp

