



CERAMIC

High Pass Filter

HFCN-3052+

50Ω 30.5 to 56.2 GHz

THE BIG DEAL

- Passband, 30.5 to 56.2 GHz
- Low Insertion Loss, Typ. 1.7 dB
- Return Loss, Typ. 14.1 dB
- Stopband Rejection, Typ. 21.4 dB
- Power Handling, 1 W
- Small Size, 1206 Surface Mount Footprint

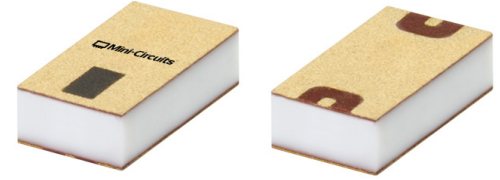

Generic photo used for illustration purposes only

APPLICATIONS

- Test & Measurement Equipment
- SATCOM
- 5G mmWave Radio Systems

FUNCTIONAL DIAGRAM

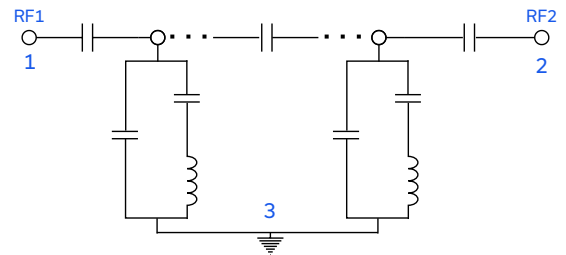

PRODUCT OVERVIEW

Mini-Circuits' HFCN-3052+ is a miniature low-temperature co-fired ceramic (LTCC) high pass filter with a 30.5 to 56.2 GHz passband supporting a variety of applications. This model provides 1.7 dB typical insertion loss over a wide band, due to its rugged monolithic construction. Housed in a tiny 1206 ceramic form factor, the filter is ideal for dense signal chain PCB layouts where it complements MMIC size and performance. The LTCC fabrication process assures minimal RF performance variation while delivering a product that is well-suited for environmental extremes of high humidity and temperature.

KEY FEATURES

Features	Advantages
Ultra-wide Passband	More than 25 GHz bandwidth for wideband applications.
Cost Effective	LTCC is a scalable technology that is cost-effective due to ease of production in high quantities.
Excellent Performance for Size	Offers best-in-class performance relative to larger-size alternative technologies. This mmWave multi-layer surface mount LTCC filter in a 1206 package allows for space to be saved in dense circuit board layouts, while also minimizing the effects of parasitics.
LTCC Construction	The use of LTCC technology allows for repeatable performance in a rugged ceramic package, well suited for tough environments such as high humidity and temperature extremes. See Mini-Circuits Environmental Rating ENV06T10 for more information.



CERAMIC

High Pass Filter

HFCN-3052+

50Ω 30.5 to 56.2 GHz

ELECTRICAL SPECIFICATIONS^{1,2,3} AT +25°C

Parameter		F#	Frequency (GHz)	Min.	Typ.	Max.	Units
Passband	Insertion Loss	F4 - F5	30.5 - 39.5	-	1.3	2.1	dB
		F5 - F6	39.6 - 45.8	-	1.7	2.7	
		F6 - F7	45.9 - 52.3	-	2.0	3.1	
		F7 - F8	52.4 - 56.2	-	2.5	3.5	
	Return Loss	F4 - F5	30.5 - 39.5	-	18.7	-	dB
		F5 - F6	39.6 - 45.8	-	14.1	-	
		F6 - F7	45.9 - 52.3	-	12.8	-	
		F7 - F8	52.4 - 56.2	-	12.8	-	
Stopband	Rejection	DC - F1	0.1 - 11.2	-	21.4	-	dB
		F1 - F2	11.3 - 23.5	-	15	-	
	Freq. Cut-Off ⁴	F3	27.2	-	3.2	-	-

1. Measured on Mini-Circuits Evaluation Board P/N TB-HFCN-3052C+ with connectors and feedline effects de-embedded using 2X Thru IEEE P370 method.
2. Bi-directional, RF1 and RF2 ports can be interchanged.
3. In applications where DC voltage and/or current is present at either the input or output ports, external DC blocking capacitors are required.
4. Typical variation ±3%.

ABSOLUTE MAXIMUM RATINGS⁵

Parameter	Ratings
Operating Temperature	-55°C to +125°C
Storage Temperature	-55°C to +125°C
Input Power ⁶	1 W max.

5. Permanent damage may occur if any of these limits are exceeded.
6. Power rating applies only to signals within the passband. Power rating above +25°C operating temperature decreases linearly to 0.5 W at +125°C.

TYPICAL FREQUENCY RESPONSE AT +25°C

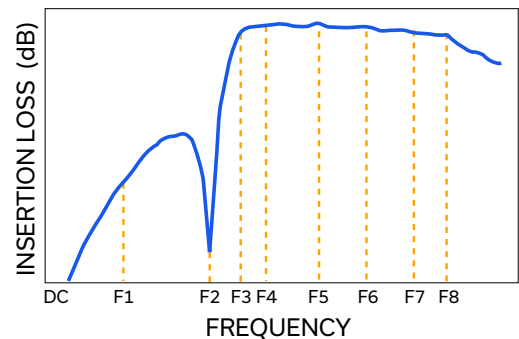



CERAMIC

High Pass Filter

HFCN-3052+

Mini-Circuits

50Ω 30.5 to 56.2 GHz

TYPICAL PERFORMANCE GRAPHS

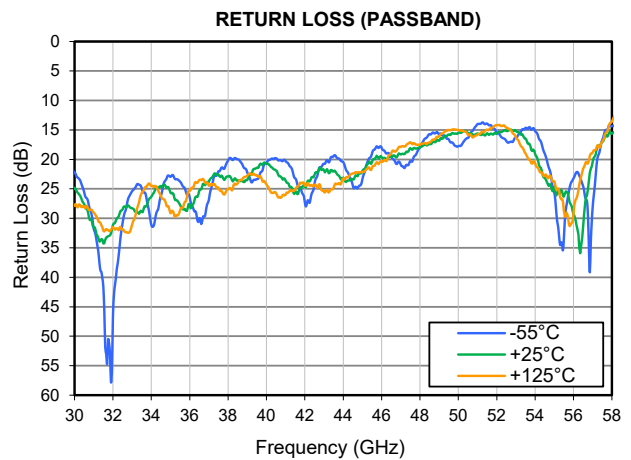
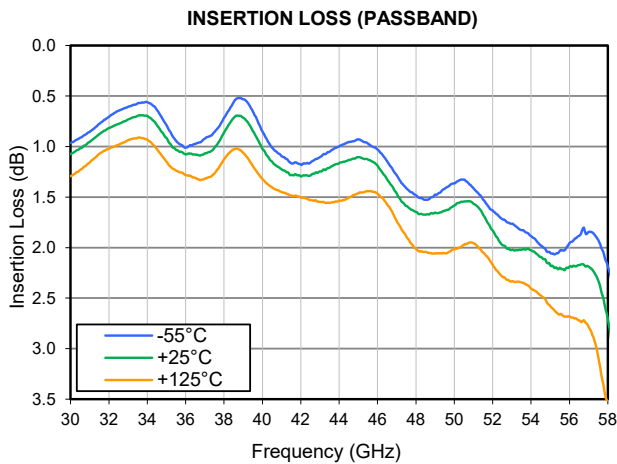
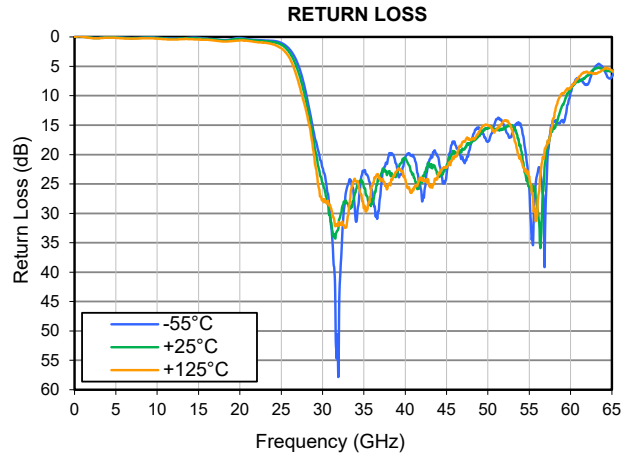
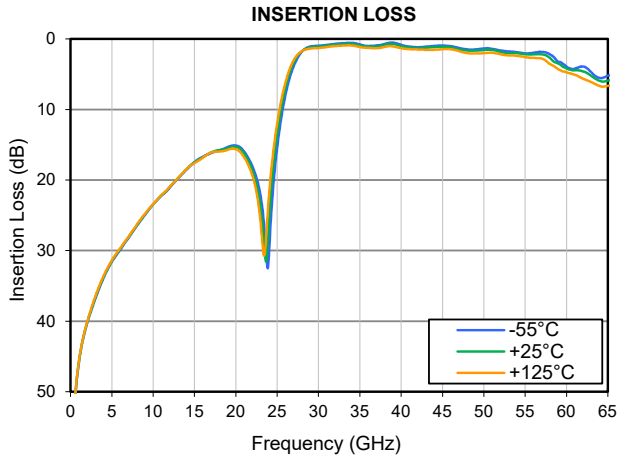



CERAMIC

High Pass Filter

HFCN-3052+

Mini-Circuits

50Ω 30.5 to 56.2 GHz

FUNCTIONAL DIAGRAM

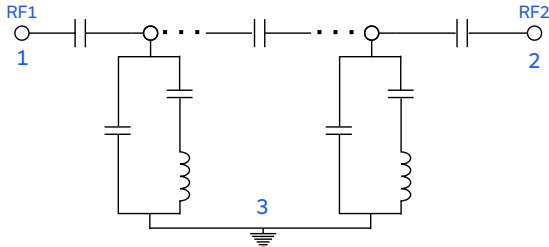
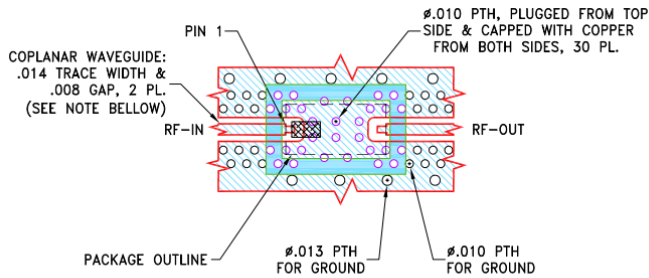

Figure 1. HFCN-3052+ Functional Diagram

PAD DESCRIPTION

Function	Pad Number	Description
RF1 ²	1	Connects to RF Input Port
RF2 ²	2	Connects to RF Output Port
GROUND	3	Connects to Ground on PCB (See drawing PL-748)

SUGGESTED PCB LAYOUT (PL-748)



NOTES:

- TRACE WIDTH & GAP PARAMETERS ARE SHOWN FOR MEGTRON-7 R5785(N); DIELECTRIC THICKNESS: .0079±.001; COPPER: HVLP/HVLP. FOR OTHER MATERIALS TRACE WIDTH & GAP MAY NEED TO BE MODIFIED.
 - BOTTOM SIDE OF THE PCB IS CONTINUOUS GROUND PLANE.
- DENOTES PCB COPPER LAYOUT WITH SMOBC (SOLDER MASK OVER BARE COPPER).
 - DENOTES COPPER LAND PATTERN FREE OF SOLDER MASK.

Figure 2. Suggested PCB Layout PL-748

CASE STYLE DRAWING

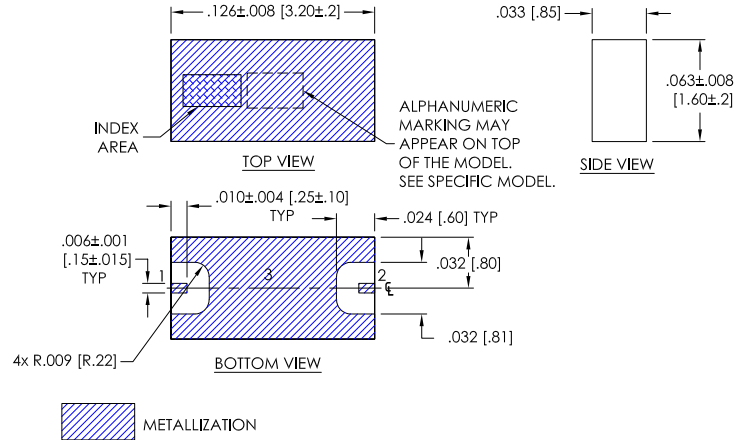

Weight: .017 grams
Dimensions are in inches [mm]. Tolerances: 2 Pl.±.03; 3Pl.±.015

PRODUCT MARKING*: XV

*Marking may contain other features or characters for internal lot control.



CERAMIC

High Pass Filter

HFCN-3052+

50Ω 30.5 to 56.2 GHz

ADDITIONAL DETAILED INFORMATION IS AVAILABLE ON OUR DASH BOARD.

[CLICK HERE](#)

Performance Data & Graphs	Data Graphs S-Parameter (S2P Files) Data Set (.zip file) De-embedded to device pads
Case Style	FV1206-12 Lead Finish: Gold over Nickel Plating
RoHS Status	Compliant
Tape and Reel	F75
Suggested Layout for PCB Design	PL-748
Evaluation Board	TB-HFCN-3052C+ Gerber File
Environmental Rating	ENV06T10

NOTES

- A. Performance and quality attributes and conditions not expressly stated in this specification document are intended to be excluded and do not form a part of this specification document.
- B. Electrical specifications and performance data contained in this specification document are based on Mini-Circuits' applicable established test performance criteria and measurement instructions.
- C. The parts covered by this specification document are subject to Mini-Circuits' standard limited warranty and terms and conditions (collectively, "Standard Terms"); Purchasers of this part are entitled to the rights and benefits contained therein. For a full statement of the standard terms and the exclusive rights and remedies thereunder, please visit Mini-Circuits' website at www.minicircuits.com/terms/viewterm.html

