



THE BIG DEAL

- Turnkey ISM-RF & MW Energy combined signal generator and system controller
- High resolution and control range of key RF signal parameters such as RF power, frequency and phase
- Output power up to +25dBm
- Supports stand-alone or multichannel operation (in either coherent or in-coherent modes)
- Works seamlessly with Mini-Circuits connectorized RF & MW Energy power amplifiers

APPLICATIONS

- Semiconductor Plasma applications
- Plasma applications
- Dielectric heating
- Solid state cooking, sterilization, disinfection and pasteurization
- Industrial heating and drying
- Medical treatments
- Analytical chemistry

PRODUCT OVERVIEW

Mini-Circuits' ISC-2425-25+ is a fully programmable, versatile and flexible small signal RF generator specifically designed to drive microwave power amplifiers and control RF Energy applications in the 2400 - 2500 MHz band. The generator and controller is housed in a metal casing (98 x 80 x 40mm) and equipped with an SMA 50Ω connector at the RF output port.

Full software support is provided, including a user-friendly GUI application, a comprehensive application programmer interface (API) and programming instructions for both Windows and Linux environments. A Labview™ instrument driver is available as well.



Generic photo used for illustration purposes only



USB & I2C

ISM Signal Generator & Controller **ISC-2425-25+**

Mini-Circuits

50Ω -30 dBm to +25 dBm 2400 to 2500 MHz

KEY FEATURES

Feature	Advantages
Dynamic range > 50 dB, the output power can vary from -30 dBm to +25 dBm in 0.01 dB steps	Enables very precise power control into any applicator Course control: 0.5 dB and Fine control: 0.01 dB
Frequency selection: with 1kHz steps in the 2.4 – 2.5 GHz ISM band	This allows the optimum frequency for the application to be set
Phase setting with 1° resolution	When multiple signal sources are used in coherent mode power can be delivered very accurately
USB-based, serial communication interface	Enables easy connection and interaction with other system controller hardware or external computers
DC supply through a dedicated two-pin connector or via a USB connector	An external DC supply enables higher power output (25 dBm) Versus 20 dBm when the supply voltage is directly from the USB port
Internal low frequency (LF) 10 MHz clock can be shared via an LVDS signal through the AUX connectors	Enables coherent operation with other external hardware and other signal generator boards
Pulse modulation and CW operation. PWM duty cycles in 1% steps, ranging from 1 – 99 %. The default PWM frequency is 1 kHz	These different power output modes of the ISC-2425-25+ allow the user to fine-tune the power to their application
Fast minimum reflected power lock and tracker	Supports optimized and efficient power delivery into any application or load by monitoring the reflected power in real-time
Closed loop mode (DLL)	The Digital Locked Loop (DLL) is an algorithm on the ISC board's microcontroller. It tunes the RF signal towards the best-matched frequency within a user-defined frequency range. The DLL is suitable for driving applications with changing impedance conditions
Feed forward (open loop) mode	In this mode, the autogain feature of the controller is switched off, and the user must determine the output power manually
Chain/coherent mode	Allows an ISC board to be configured as stand-alone or master or slave in a chain of ISC controllers. This is useful for specific use cases such as phase-coherent heating
Integrated powerful microcontroller	Capable of accommodating the board control firmware and user-defined application-level SW
Application programmer's interface	The user can create their control program to control the RF generator
Power amplifier status inputs	The user can read the calibrated RF power, current and temperature measurements from Mini-Circuits connectorized amplifiers such as the ZHL-2425-250X+
Embedded memory	The user can store calibration data, use-case profiles, modulation patterns etc.
Dedicated I2C functions	Enables easy communication with connected power amplifier modules such as the ZHL-2425-250X+
Fast reflected power sweep across the frequency band (2.4 to 2.5 GHz)	Allows the user to adapt the system in real time to dynamic load conditions
Safe operating area (SOA), (configurable, fast protection algorithms)	Allows the user to set limits to ensure the power amplifier is protected against thermal and RF overstress

Trademarks: Windows is a registered trademark of Microsoft Corporation in the United States and other countries. Linux is a registered trademark of Linus. Neither Mini-Circuits nor the Mini-Circuits ISC-series of ISM RF & MW signal generators and controllers are affiliated with or endorsed by the owners of the above referenced trademarks. Mini-Circuits and the Mini-Circuits logo are registered trademarks of Scientific Components Corporation.

APPLICATION SUPPORT:

- Easy to integrate with Mini-Circuits connectorized RF & MW Energy amplifiers providing automatic output power calibration control and system protection
- Closed loop RF output power control
- Feedforward (open loop) RF power control mode to explore unknown load conditions
- Fast minimum reflected power lock and tracker for optimized and efficient power delivery into any application / load
- Single channel and multi-channel operation
- Coherent and incoherent operation in multi-channel environment





ELECTRICAL SPECIFICATIONS (GENERAL RF) AT +25°C AND 5.5V SUPPLY

Parameter	Symbol	Frequency (MHz)	Min.	Max.	Units
RF Output power ¹	P_{OUT}	2400-2500	0.001 -30	320 25	mW dBm
Output power control resolution (linear)	P_{OUT_CTRL}	2400-2500	0.01	0.1	dB
Frequency band	f	2400-2500	2400	2500	MHz
Frequency resolution	f_{RES}	2400-2500	1	—	kHz
Phase control range	θ	2400-2500	0	360	Deg
Phase control resolution	θ_{RES}	2400-2500	1	—	Deg
Supply voltage	V_{DC}	2400-2500	5.0	5.5	V
Supply current	I_{DC}	2400-2500	0.5	1.1	A
PWM duty cycle	PWM-DC	2400-2500	1	99	%
PWM frequency (internal)	PWM-Freq	2400-2500	—	1 (fixed)	kHz

1. Output power approx. 20dBm when USB port is used for supply voltage

BLOCK DIAGRAM

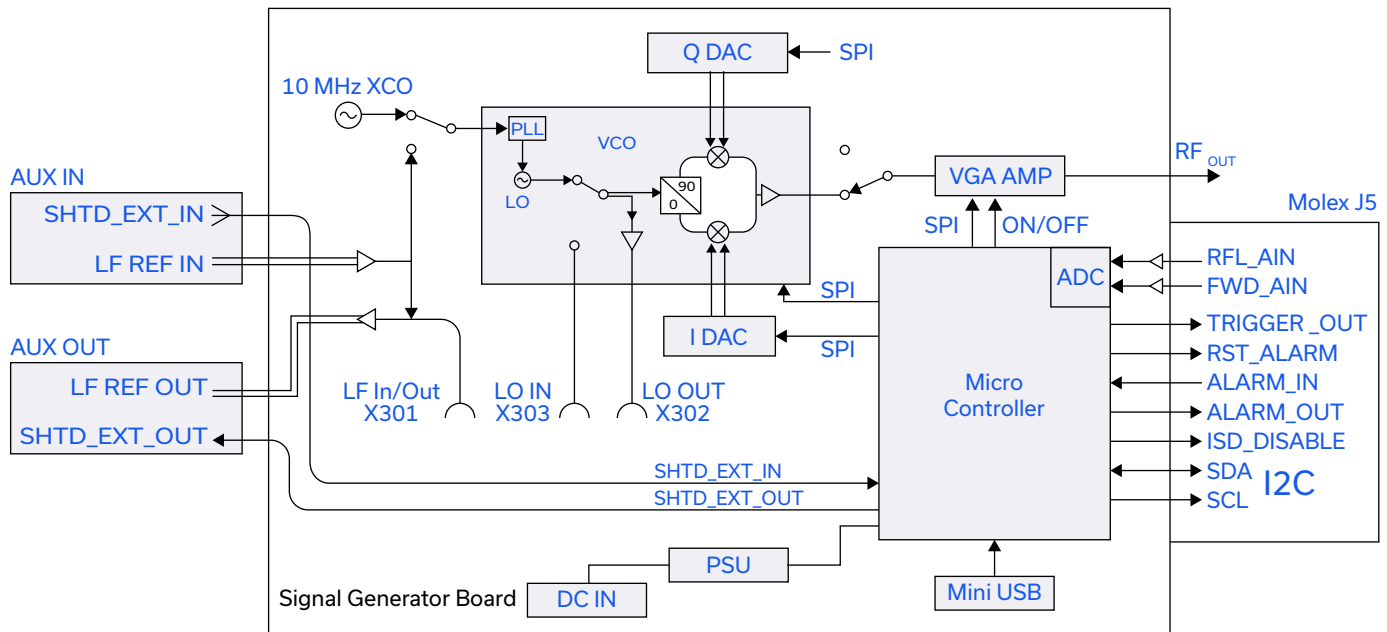



USB & I2C

ISM Signal Generator & Controller **ISC-2425-25+**

Mini-Circuits

50Ω -30 dBm to +25 dBm 2400 to 2500 MHz

CASE STYLE DRAWING

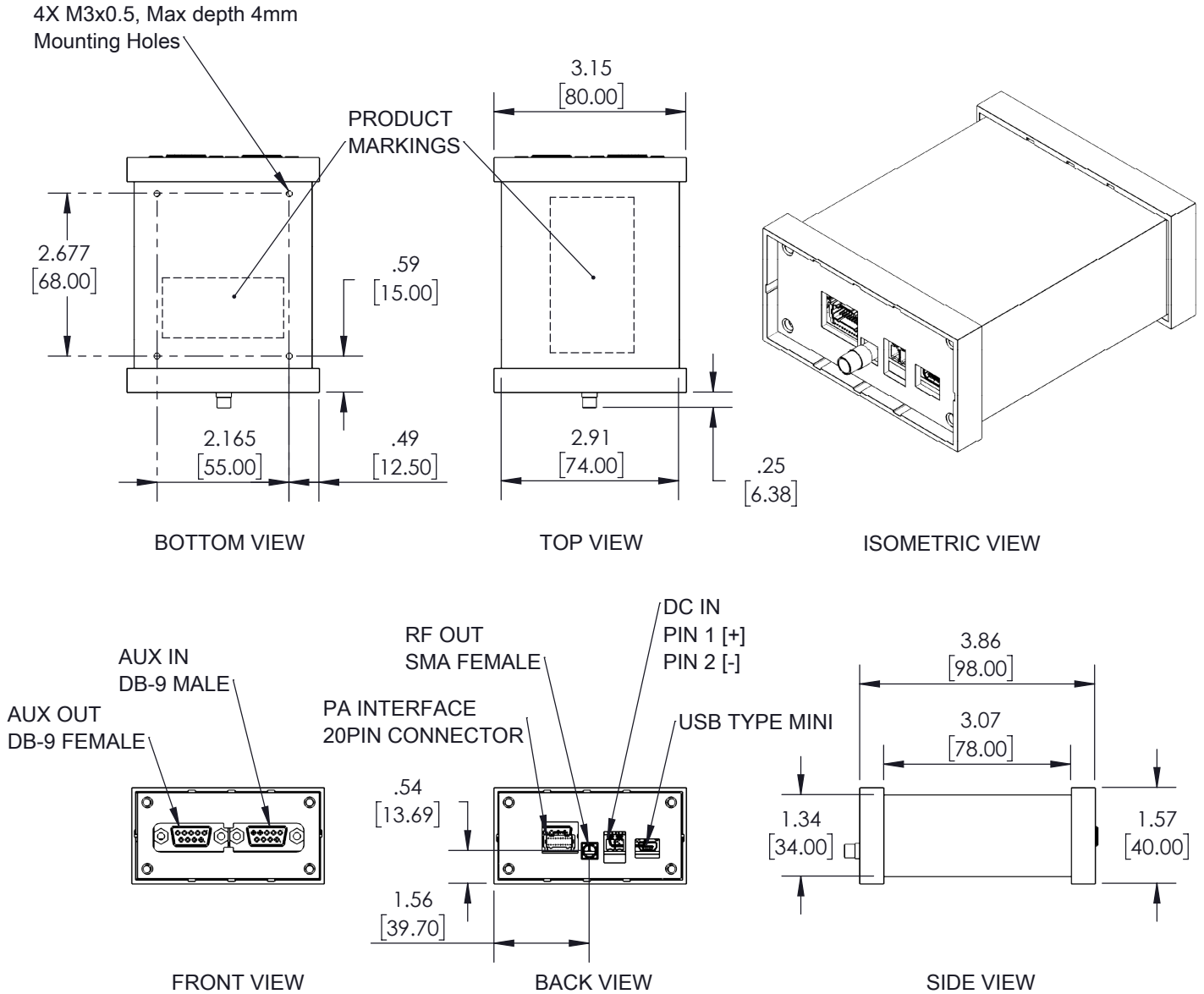

Weight: 181 grams

Dimensions are in inches [mm]. Tolerances: 2 Pl. ±0.016 inch [0.4mm]

PRODUCT MARKING*: ISC-2425-25+

*Marking may contain other features or characters for internal lot control.



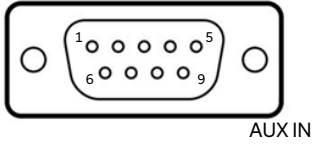

AUX IN

AUX IN (Sub-D-9 male) for system related signals:			
1	10 MHz differential clock signal (-) (LF REF IN)	6	10 MHz differential clock signal (+) (LF REF IN)
2	Reserved	7	Reserved
3	GND	8	External shutdown (in) (SHTD_EXT_IN)
4	Reserved	9	Reserved
5	GND		

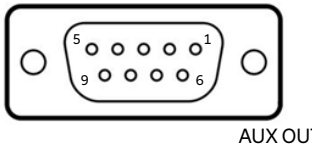

AUX OUT

AUX OUT (Sub-D-9 female) for system related signals:			
1	10 MHz differential clock signal (-) LF REF OUT	6	10 MHz differential clock signal (+) LF REF OUT
2	Reserved	7	Reserved
3	GND	8	External shutdown (out) (SHTD_EXT_OUT)
4	Reserved	9	Reserved
5	GND		

20-PIN MOLEX INTERFACE

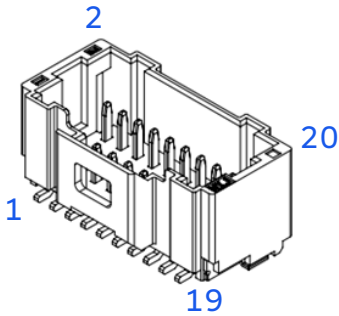

Pin Number	Label	Functionality and Control
1	TRIG_OUT	Used during pulse mode operation
2	RFL_AIN	Analog input voltage (3.0V max); can be correlated to a reflected power measurement of a connected amplifier
3	RST_ALARM	Digital output signal; Used to reset an alarm/shutdown condition of a connected amplifier with logic high level
4	FWD_AIN	Analog input voltage (3.0V max); can be correlated to a forward power measurement of a connected amplifier
5	PA_ENABLE	Digital output: to enable/disable a connected amplifier (normally low)
6	Do not connect	Reserved pin for manufacturer
7	ALARM_OUT	Digital output signal; can be used to send an alarm status to a connected device (normally low)
8	Do not connect	Reserved pin for manufacturer
9	ISD_DISABLE	Digital output signal; can be used to e.g. disable protection hardware in connected hardware (normally low)
10	GND	Ground
11	ALARM_IN	Digital input signal; can be used to receive an alarm status from a connected device (normally low)
12	GND	Ground
13	SCL	I2C control
14	GND	Ground
15	SDA	I2C control
16	GND	Ground
17	Do not connect	Reserved pin for manufacturer
18	Do not connect	Reserved pin for manufacturer
19	Do not connect	Reserved pin for manufacturer
20	Do not connect	Reserved pin for manufacturer



USB & I2C

ISM Signal Generator & Controller **ISC-2425-25+**

Mini-Circuits

50Ω -30 dBm to +25 dBm 2400 to 2500 MHz

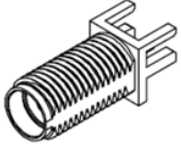

SMA RF Output connector	Female
-------------------------	--------



USB Connector	
Communications and auxiliary power supply	Mini USB 2.0

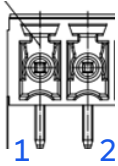

DC Power supply connector Phoenix Contact MC 1.5/ 2-G-3.81	
Pin1 (closest to SMA output): +5.5V	Pin 2: GND



TYPICAL PERFORMANCE CURVES*

The controller determines the RF output power through a course attenuation setting (in dB) via the instruction \$GCS command in 0.5dB steps between 0 to 30.5 dB and then a fine magnitude setting between 0 and 100 percent with a resolution of better than 0.01 (the \$MCS command). In the following, typical performance curves are given for different frequencies and settings for attenuation and magnitude. Output power vs. magnitude setting at different attenuation settings and frequencies: (the bands around the curves denote the typical product spread)

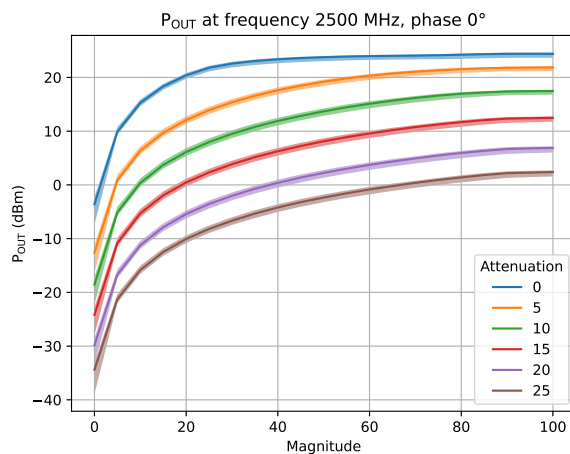
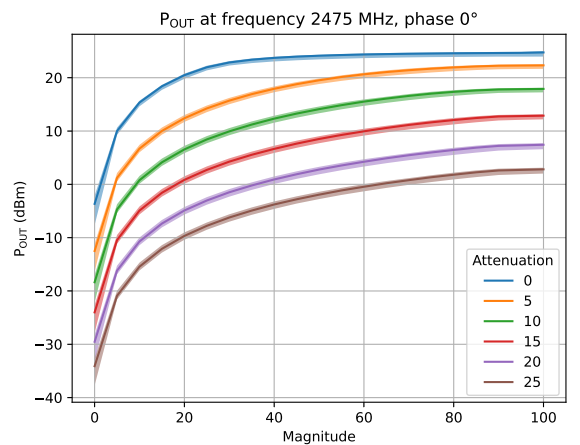
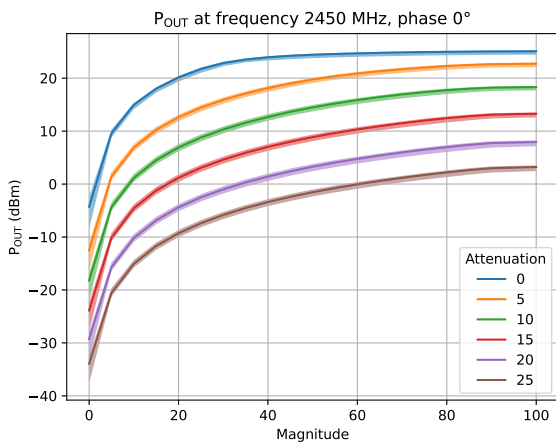
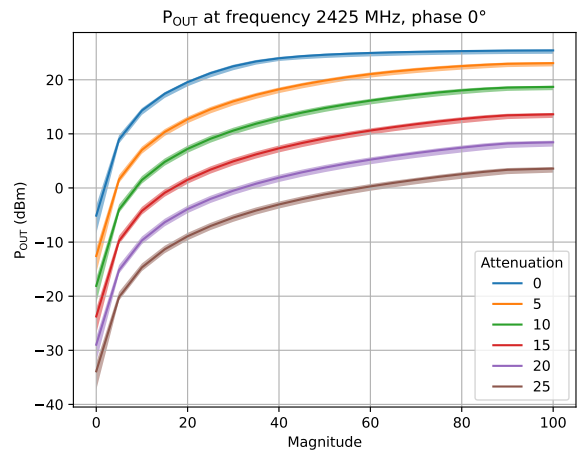
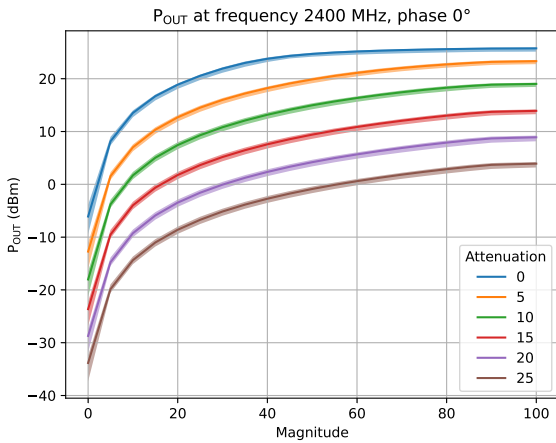



Output power vs. frequency setting at different attenuation settings and magnitudes:
(the bands around the curves denote the typical product spread)

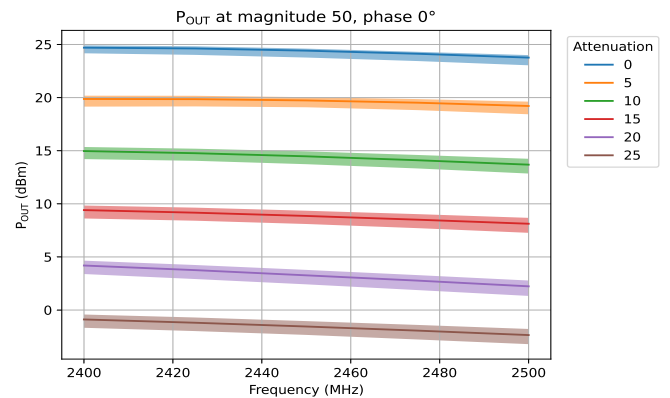
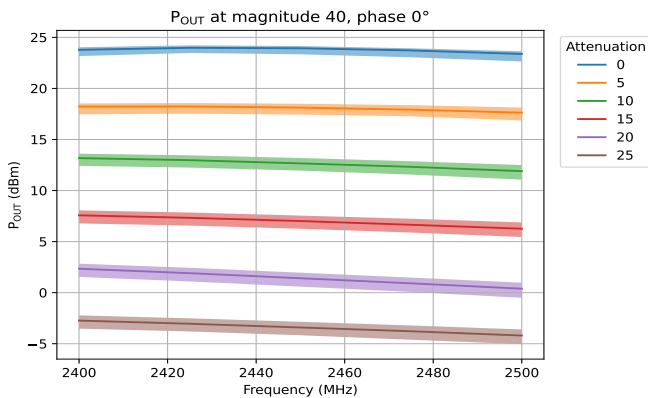
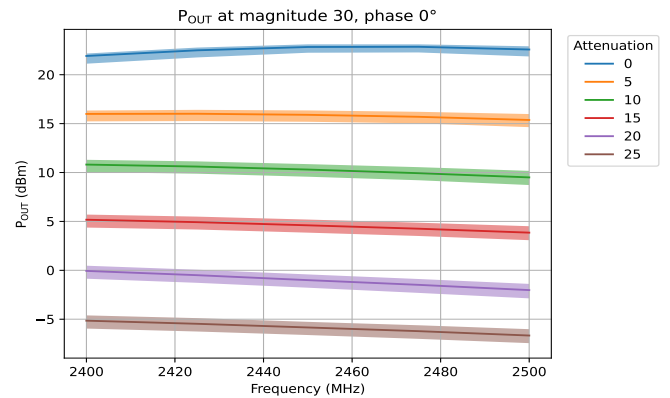
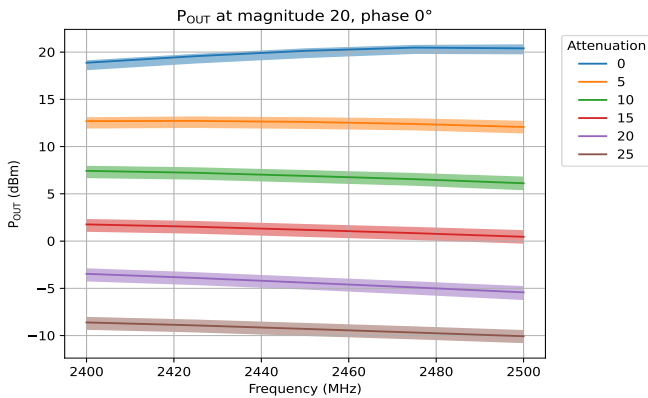
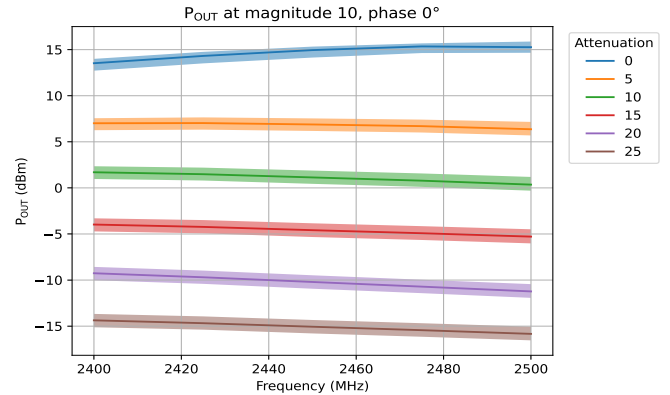
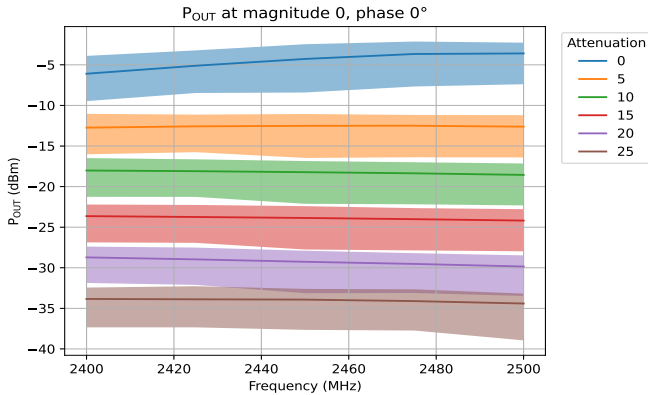



Output power vs. frequency setting at different attenuation settings and magnitudes:
(the bands around the curves denote the typical product spread)

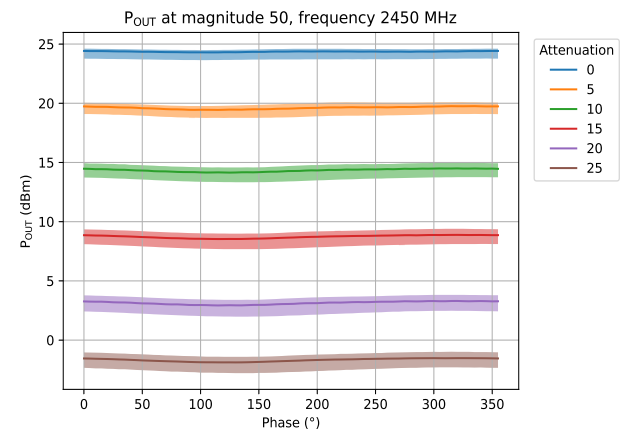
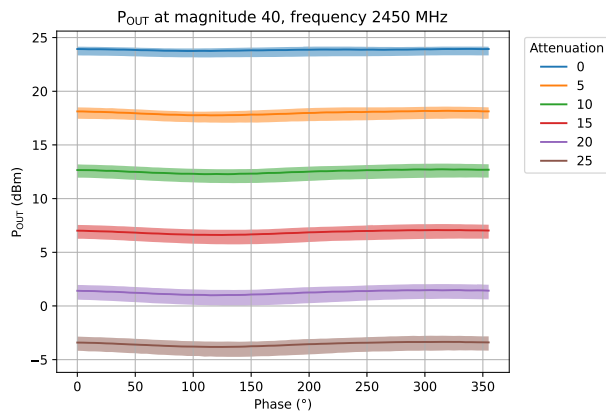
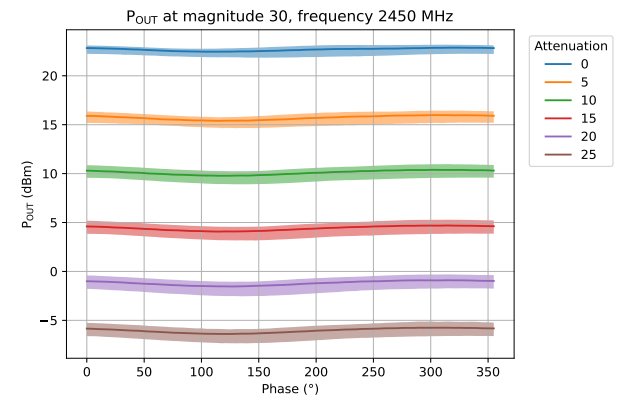
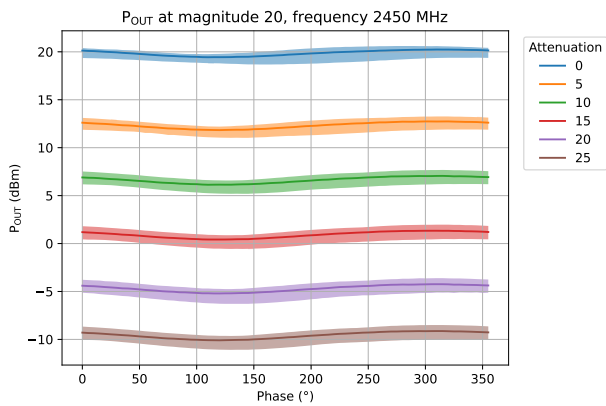
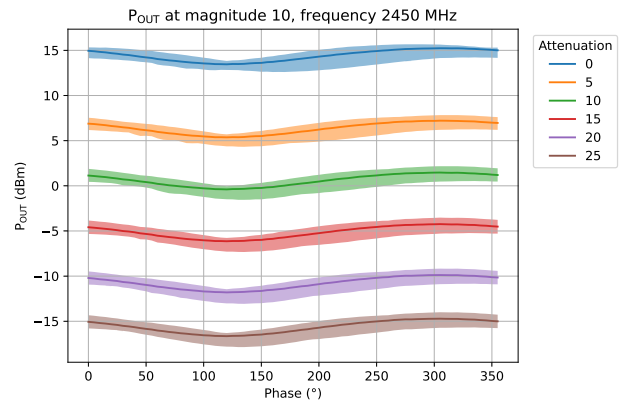
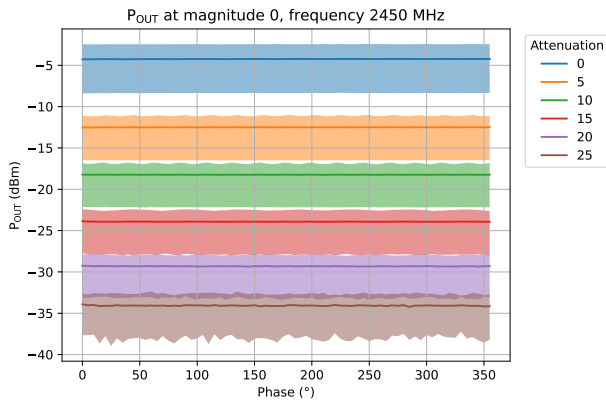



ABSOLUTE MAXIMUM RATINGS

Parameter	Ratings
Operating Temperature	+10°C to +40°C
Storage Temperature	-20°C to +60°C
Maximum Supply Voltage	6.0V
Voltage input to digital IOs	-0.2VDC ≤ V ≤ +3.5VDC
External M-LVDS reference clock signal	-1.4V ≤ V ≤ 3.8Vpp

Permanent damage may occur if any of these limits are exceeded. Operating in the range between operating power limits and absolute maximum ratings for extended periods of time may result in reduced life and reliability.

SOFTWARE & DOCUMENTATION DOWNLOAD:

Full software support is provided, including a user-friendly GUI application, a comprehensive application programmer interface (API) and programming instructions for both Windows and Linux environments. A Labview™ instrument driver is available as well. The latest version of the full software package can be downloaded from www.minicircuits.com/softwaredownload/RF-Energy-software_download.html at any time.

MINIMUM SYSTEM REQUIREMENTS

Parameter	Requirements
System requirements	GUI Windows: Windows 7 or newer.
	GUI Linux: Raspberry Pi 3 hardware; USB, Ethernet (for GUI's remote command mode); operating system: Raspbian Stretchd or newer.
	Operating system ≥ Debian 9 or similar

GRAPHICAL USER INTERFACE (GUI) KEY FEATURES:

- Set frequency
- Set power
- Configure generator state at power-up
- Track real time optimum S11 frequency (ALL – analog or Digital Locked Loop -DLL routine)
- CW & Pulse width modulation signals
- Forward and reflected power tracking real time
- Control of signal gen and controller

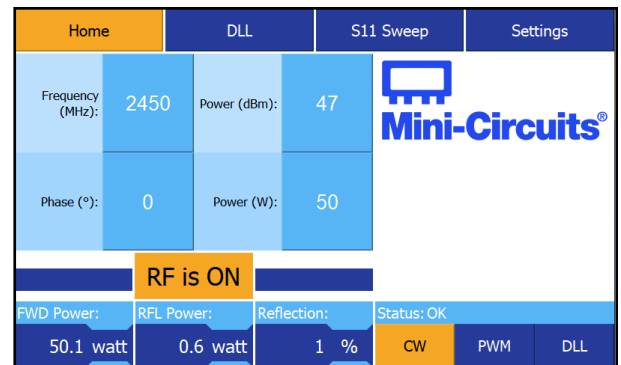

APPLICATION PROGRAMMING INTERFACE (API) SUPPORT:

- Application programmer's interface (API) implemented through plain-text command language



RF & MW

ISM Signal Generator & Controller **ISC-2425-25+**

50Ω -30 dBm to +25 dBm 2400 to 2500 MHz





Mini-Circuits

DETAILED INFORMATION IS AVAILABLE ON OUR WEBSITE [CLICK HERE](#)

Case Style	VM3246
RoHs Status	Compliant
Environmental Ratings	ENV56T2

ORDERING INFORMATION

Please contact Mini-Circuits' Applications department for price and availability: ISMRFMWenergy@minicircuits.com

Included Accessories	Part Number	Description
	086-8SMMCX+	SMA-Male to MCX-Male HandFlex Cable, DC-6 GHz, 8"
	086-12SMMCX+	SMA-Male to MCX-Male HandFlex Cable, DC-6 GHz, 12"
	K086-8SMMCX1+	Qty. 4 Interconnect HandFlex Cable Kit, SMA-Male to MCX Male, DC-6 GHz, 8", Phase Matched
	K086-12SMMCX1+	Qty. 4 Interconnect HandFlex Cable Kit, SMA-Male to MCX Male, DC-6 GHz, 12", Phase Matched
		USB - USB mini 1m I2C bus cable (Molex to Molex) DC power supply connector

COMPANION PRODUCTS:

- Mini-Circuits connectorized RF & MW Energy power amplifiers

NOTES

- Performance and quality attributes and conditions not expressly stated in this specification document are intended to be excluded and do not form a part of this specification document.
- Electrical specifications and performance data contained in this specification document are based on Mini-Circuit's applicable established test performance criteria and measurement instructions.
- The parts covered by this specification document are subject to Mini-Circuits standard limited warranty and terms and conditions (collectively, "Standard Terms"); Purchasers of this part are entitled to the rights and benefits contained therein. For a full statement of the standard terms and the exclusive rights and remedies thereunder, please visit Mini-Circuits' website at www.minicircuits.com/terms/viewterm.html

