



MMIC SURFACE MOUNT

SPDT RF Switch

M3SWA2-34DR+

50 Ω DC to 30 GHz Absorptive RF Switch with Internal Driver

THE BIG DEAL

- Wideband, DC to 30 GHz
- Low Insertion Loss, Typ. 1.0 dB
- High Isolation, Typ. 65 dB
- High Input IP3, Typ. +48 dBm
- Fast Rise/Fall Time, Typ. 6.9 ns/7.1 ns
- 3x3 mm, 16-Lead QFN-Style Package

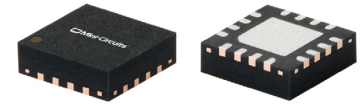

Generic photo used for illustration purposes only

APPLICATIONS

- Radar, EW and ECM Defense Systems
- Communication Infrastructure
- Test and Measurement

FUNCTIONAL DIAGRAM

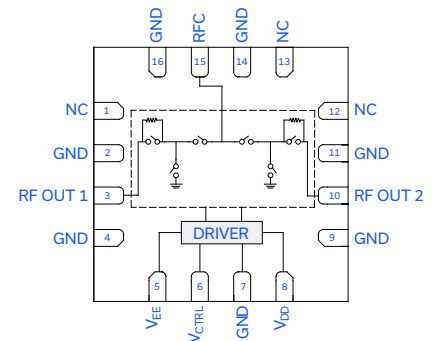

PRODUCT OVERVIEW

Mini-Circuits' M3SWA2-34DR+ is a GaAs MMIC SPDT absorptive switch with an internal driver designed for wideband operation from DC to 30 GHz. This switch enables fast, nano-second switching across a wide frequency range with no gate lag effects. This model provides excellent isolation, high linearity and is capable of withstanding +27 dBm RF input power. It is packaged in a small 3x3 mm QFN-Style package for ease of integration in compact assemblies.

KEY FEATURES

Features	Advantages
Absorptive Design	Absorptive switch design enables excellent return loss on all ports, minimizing reflection at the unselected port.
High Isolation: <ul style="list-style-type: none"> • 61 dB Typ. RFC to RF1/RF2 • 65 dB Typ. RF1 to RF2 	High isolation significantly reduces leakage of power into OFF ports.
High Linearity and Input Power: <ul style="list-style-type: none"> • Input Power at P1dB, +25.2 dBm Typ. • Input IP3, +48 dBm Typ. • Max RF Input Power, +27 dBm CW 	High linearity minimizes unwanted intermodulation products which are difficult or impossible to filter in multi-carrier environments, or in the presence of strong interfering signal from adjacent circuitry. High RF input power tolerance protects the device from damage due to unexpected spikes in signal level.
Fast RF Switching Time: <ul style="list-style-type: none"> • Rise/Fall Time, Typ. 6.9 ns/7.1 ns • On/Off Time, Typ. 23.3 ns/16.5 ns • Settling to 0.05 dB, Typ. 29 ns 	Fast switching makes this model suitable for applications where extremely fast transition between ports is required, such as automated switching networks.
Compact Size, 3x3 mm	Small footprint saves space in dense layouts, while providing low inductance, repeatable transitions, and excellent thermal contact to the PCB. Industry standard packaging allows for ease of assembly in high volume manufacturing processes.





MMIC SURFACE MOUNT

SPDT RF Switch

M3SWA2-34DR+

50 Ω DC to 30 GHz Absorptive RF Switch with Internal Driver

ELECTRICAL SPECIFICATIONS^{1,2,3} AT +25° C, V_{DD}= +3.3 V, V_{EE}= -3.3 V, UNLESS NOTED OTHERWISE

Parameter	Condition (GHz)	Min.	Typ.	Max.	Units
Frequency Range		DC		30	GHz
Insertion Loss	0.01		0.6		dB
	0.1		0.6		
	1.0		0.6		
	10		1.0		
	20		1.3		
	30		2.2		
Isolation Between Ports, RF1 & RF2	0.01	68	79		dB
	0.1	74	78		
	1.0	63	67		
	10	59	65		
	20	49	53		
	30	44	48		
Isolation Between RFC & RF1/RF2 Ports	0.01	71	83		dB
	0.1	73	77		
	1.0	61	65		
	10	46	50		
	20	41	48		
	30	41	45		
Return Loss - RFC	0.01	15	19		dB
	0.1	20	24		
	1.0	17	21		
	10	13	17		
	20	12	17		
	30	13	20		
Return Loss - RF1 & RF2 (On & Off State)	0.01	15	19		dB
	0.1	16	22		
	1.0	17	22		
	10	14	21		
	20	11	17		
	30	7	14		
Input IP3 (P _{IN} = +5 dBm/Tone)	0.01		+46		dBm
	0.1		+50		
	1.0		+52		
	10		+51		
	20		+46		
	30		+42		
Input Power at P1dB	0.01		+19.8		dBm
	0.1		+24.5		
	1.0		+26.1		
	10		+27.4		
	20		+27.8		
	30		+25.7		
Input Power at P0.1dB	0.01		+17.7		dBm
	0.1		+21.6		
	1.0		+23.4		
	10		+26.3		
	20		+26.9		
	30		+24.4		

1. Tested on Mini-Circuits Characterization Test Board TB-M3SWA234DRC+. See Figure 2.

2. Bi-directional, refer to S-Parameters for actual performance.

3. All RF-ports must be DC blocked or held at 0V DC.





DC ELECTRICAL SPECIFICATIONS

Parameter	Min.	Typ.	Max.	Units
Positive Supply Voltage, V_{DD}	+3.3		+3.6	V
Negative Supply Voltage, V_{EE}	-3.6		-3.3	V
Positive Supply Current, I_{DD}		2.7	2.9	mA
Negative Supply Current, I_{EE}		1.6	1.8	mA
Control Voltage Low		0	+0.8	V
Control Voltage High	+1.8	+2	+3.6	V
Control Current Low		0.01	1	μ A
Control Current High		5	9	μ A

SWITCHING SPECIFICATIONS

Parameter	Condition	Min.	Typ.	Max.	Units	
ON Time, 50% Control to 90% RF output	RF P_{IN} at RFC = 0 dBm RF Frequency = 150 MHz Control Frequency = 1 kHz Control High = +2 V Control Low = 0 V		23		ns	
OFF Time, 50% Control to 10% RF output			16		ns	
Video Leakage			+5.4		mV	
Rise Time, 10% to 90% of RF output				6.9		ns
Fall Time, 90% to 10% of RF output				7.1		ns
Settling time (50% VCTRL to 0.05 dB of final RF output)				29		ns

TRUTH TABLE

State of Control Voltage	RFC to RF1	RFC to RF2
Low	ON	OFF
High	OFF	ON



TYPICAL PERFORMANCE GRAPHS

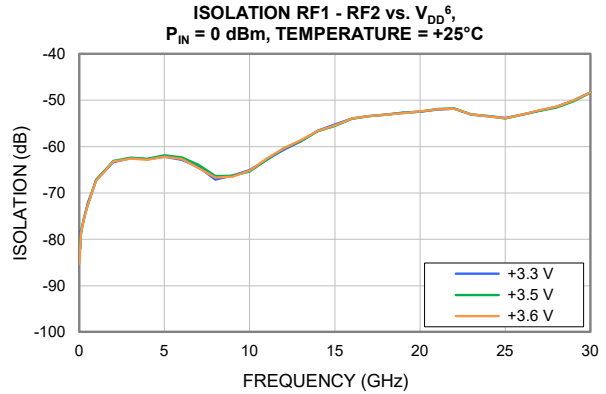
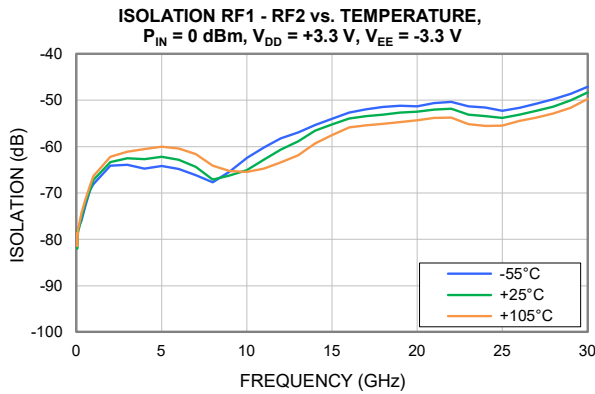
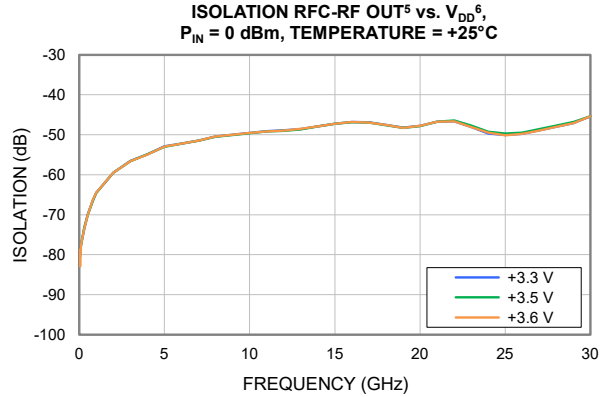
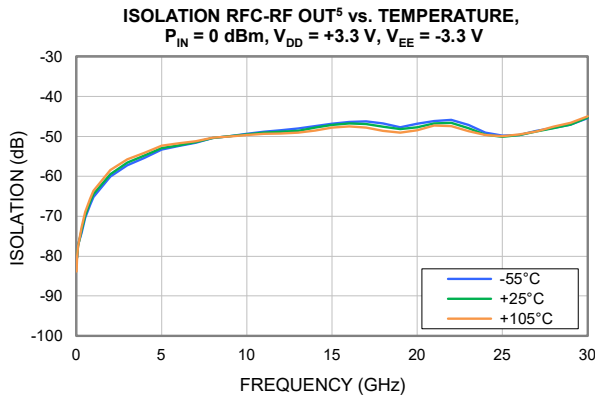
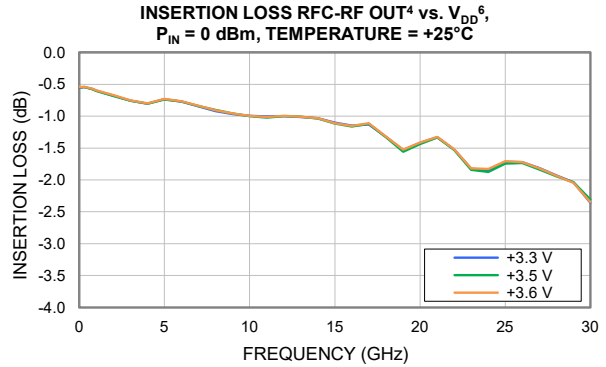
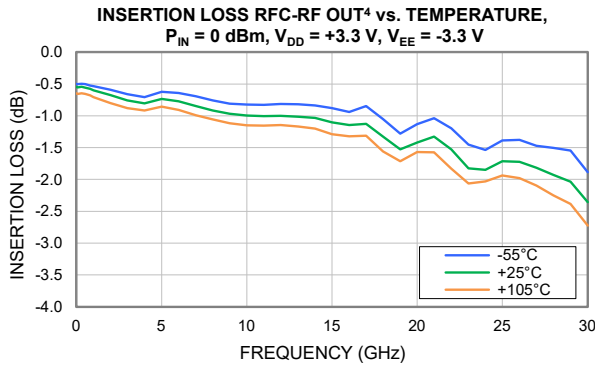

- 4. RF OUT is defined as either RF1 (ON) or RF2 (ON)
- 5. RF OUT is defined as either RF1 (OFF) or RF2 (OFF)
- 6. V_{EE} is the negative equivalent value to V_{DD}



TYPICAL PERFORMANCE GRAPHS

RFC INPUT RETURN LOSS vs. TEMPERATURE,
 $P_{IN} = 0 \text{ dBm}, V_{DD} = +3.3 \text{ V}, V_{EE} = -3.3 \text{ V}$

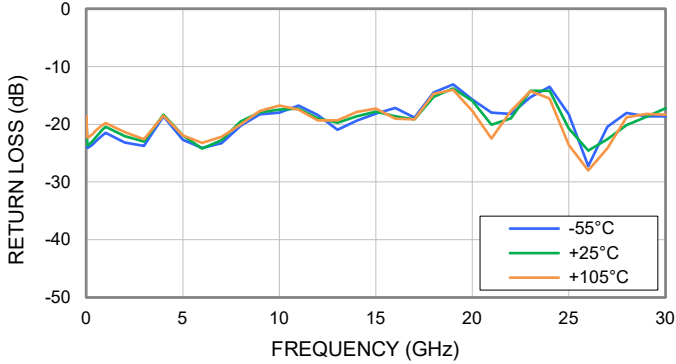

RFC INPUT RETURN LOSS vs. V_{DD} ,⁶
 $P_{IN} = 0 \text{ dBm}, \text{TEMPERATURE} = +25^\circ\text{C}$

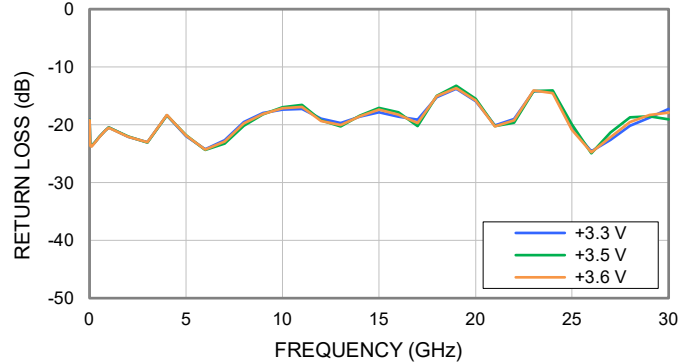

RF1 (ON) OUTPUT RETURN LOSS vs. TEMPERATURE,
 $P_{IN} = 0 \text{ dBm}, V_{DD} = +3.3 \text{ V}, V_{EE} = -3.3 \text{ V}$

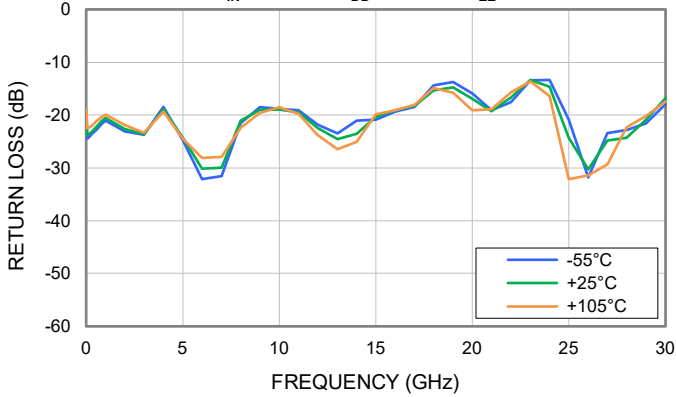

RF1 (ON) OUTPUT RETURN LOSS vs. V_{DD} ,⁶
 $P_{IN} = 0 \text{ dBm}, \text{TEMPERATURE} = +25^\circ\text{C}$

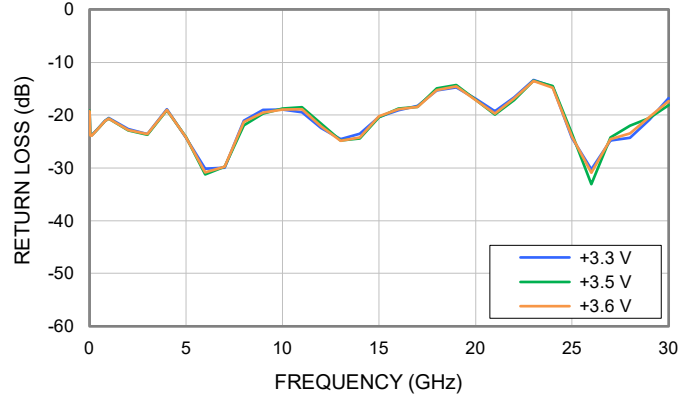

RF1 (OFF) OUTPUT RETURN LOSS vs. TEMPERATURE,
 $P_{IN} = 0 \text{ dBm}, V_{DD} = +3.3 \text{ V}, V_{EE} = -3.3 \text{ V}$

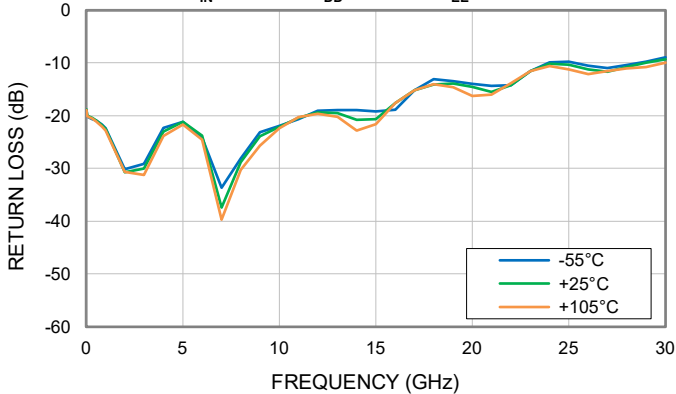

RF1 (OFF) OUTPUT RETURN LOSS vs. V_{DD} ,⁶
 $P_{IN} = 0 \text{ dBm}, \text{TEMPERATURE} = +25^\circ\text{C}$

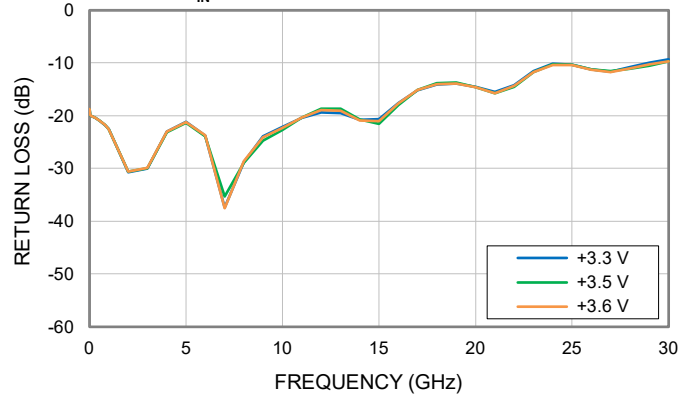

- 4. RF OUT is defined as either RF1 (ON) or RF2 (ON)
- 5. RF OUT is defined as either RF1 (OFF) or RF2 (OFF)
- 6. V_{EE} is the negative equivalent value to V_{DD}



TYPICAL PERFORMANCE GRAPHS

RF2 (ON) OUTPUT RETURN LOSS vs. TEMPERATURE,
 $P_{IN} = 0 \text{ dBm}$, $V_{DD} = +3.3 \text{ V}$, $V_{EE} = -3.3 \text{ V}$

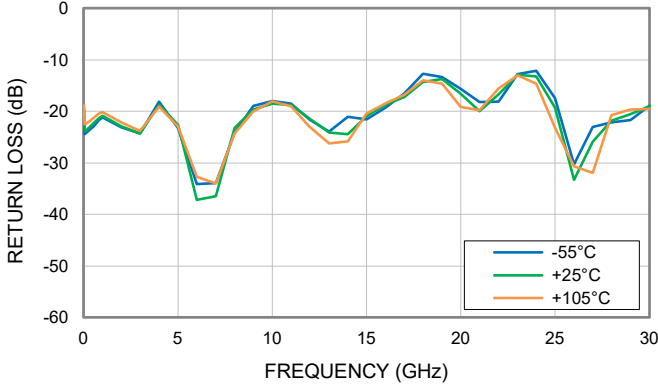

RF2 (ON) OUTPUT RETURN LOSS vs. V_{DD} ,⁶
 $P_{IN} = 0 \text{ dBm}$, TEMPERATURE = +25°C

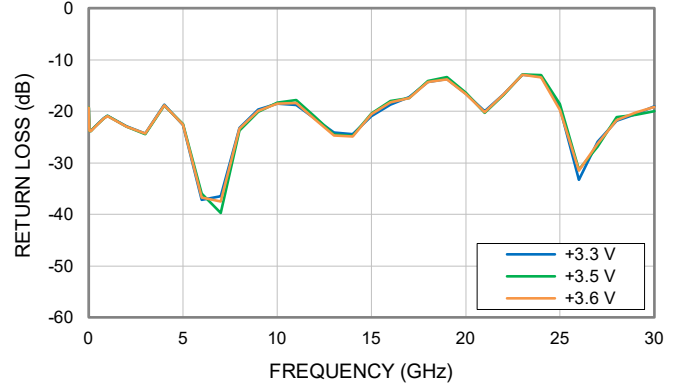

RF2 (OFF) OUTPUT RETURN LOSS vs. TEMPERATURE,
 $P_{IN} = 0 \text{ dBm}$, $V_{DD} = +3.3 \text{ V}$, $V_{EE} = -3.3 \text{ V}$

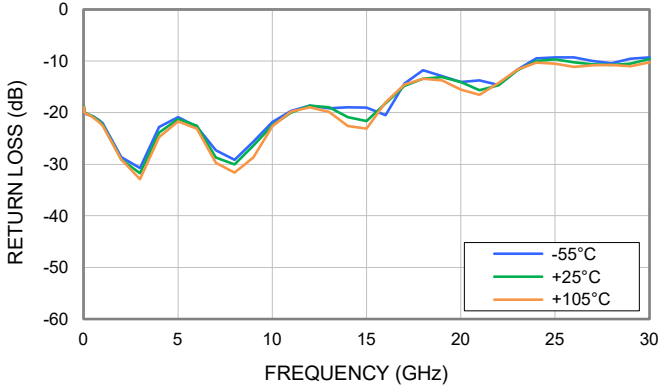

RF2 (OFF) OUTPUT RETURN LOSS vs. V_{DD} ,⁶
 $P_{IN} = 0 \text{ dBm}$, TEMPERATURE = +25°C

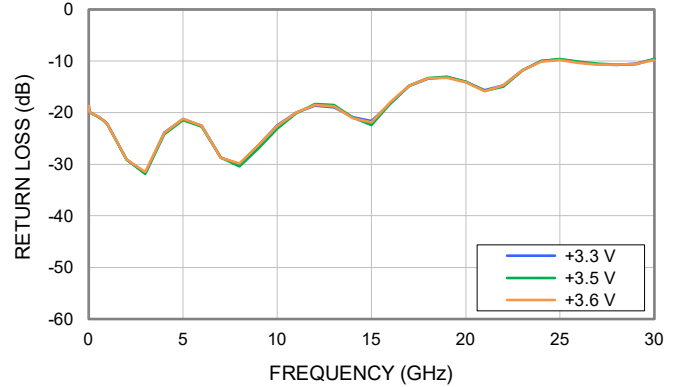

INPUT P1dB vs. TEMPERATURE,
 $V_{DD} = +3.3 \text{ V}$, $V_{EE} = -3.3 \text{ V}$

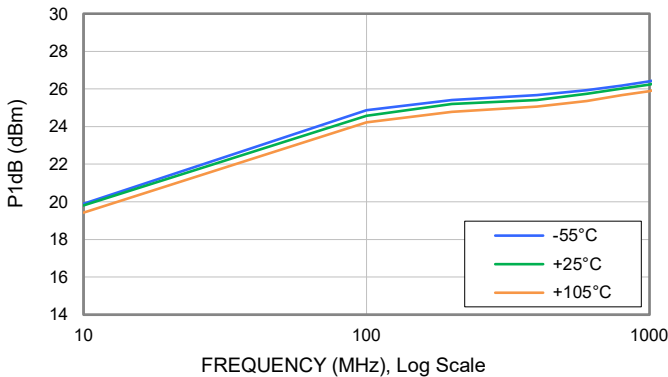

INPUT P1dB vs. V_{DD} ,⁶
TEMPERATURE = +25°C

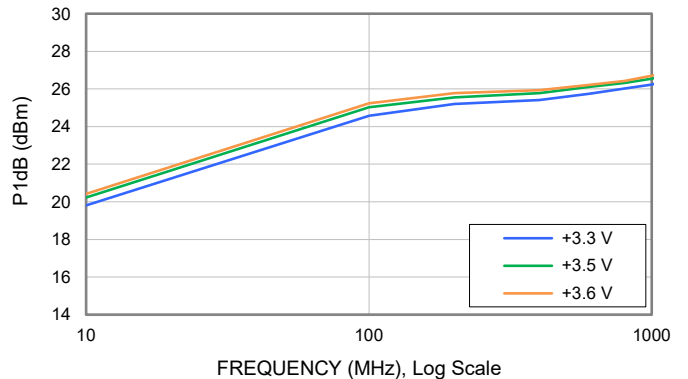

4. RF OUT is defined as either RF1 (ON) or RF2 (ON)
5. RF OUT is defined as either RF1 (OFF) or RF2 (OFF)
6. V_{EE} is the negative equivalent value to V_{DD}



TYPICAL PERFORMANCE GRAPHS

INPUT P1dB vs. TEMPERATURE,
 $V_{DD} = +3.3\text{ V}$, $V_{EE} = -3.3\text{ V}$

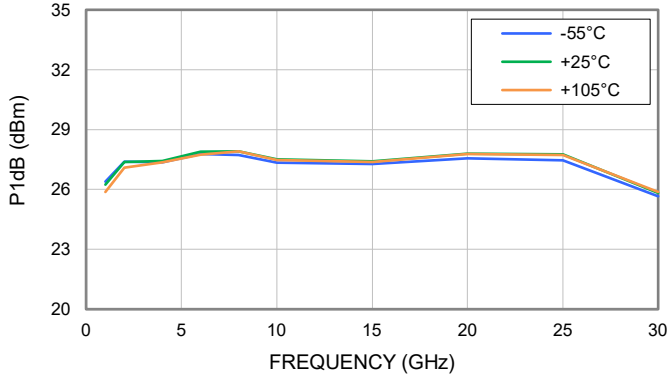

INPUT P1dB vs. V_{DD}^6 ,
TEMPERATURE = +25°C

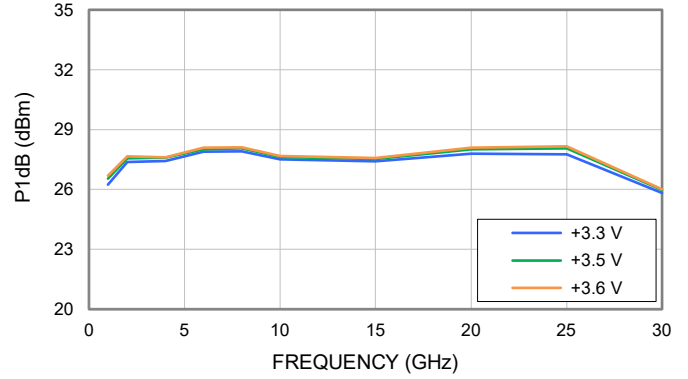

INPUT P0.1dB vs. TEMPERATURE,
 $V_{DD} = +3.3\text{ V}$, $V_{EE} = -3.3\text{ V}$

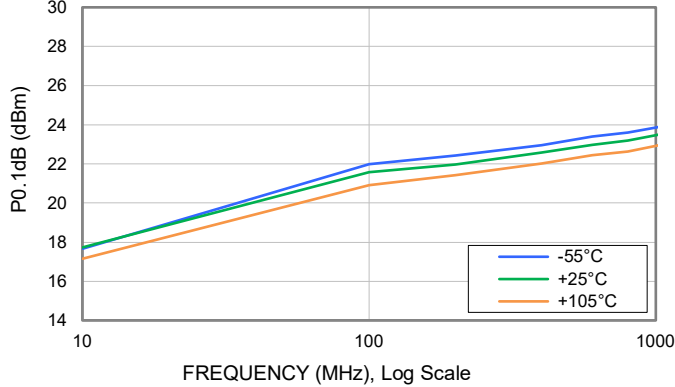

INPUT P0.1dB vs. V_{DD}^6 ,
TEMPERATURE = +25°C

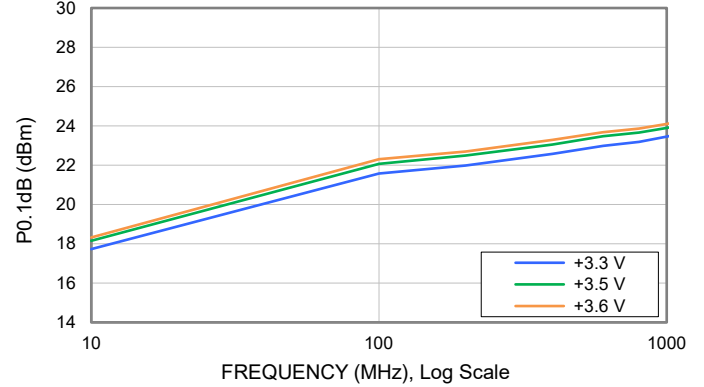

INPUT P0.1dB vs. TEMPERATURE,
 $V_{DD} = +3.3\text{ V}$, $V_{EE} = -3.3\text{ V}$

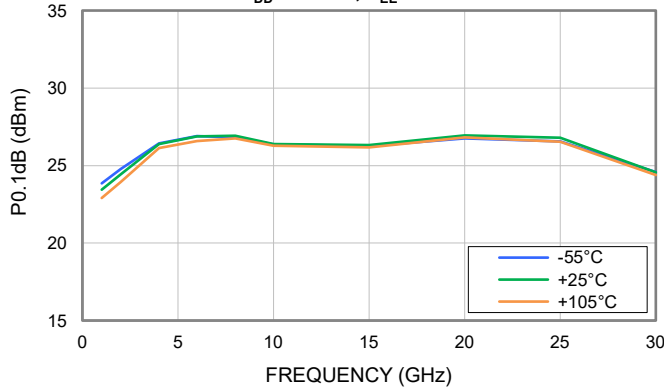

INPUT P0.1dB vs. V_{DD}^6 ,
TEMPERATURE = +25°C

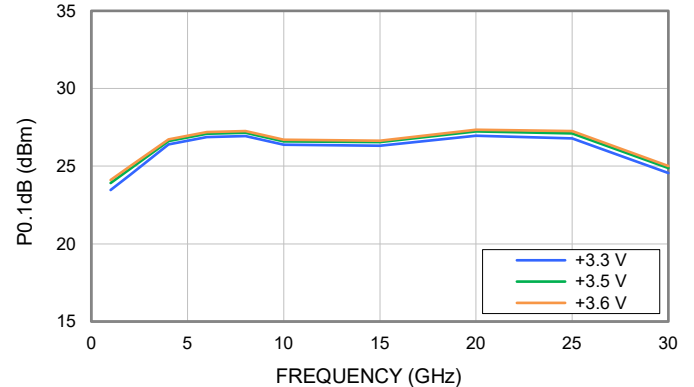

4. RF OUT is defined as either RF1 (ON) or RF2 (ON)
5. RF OUT is defined as either RF1 (OFF) or RF2 (OFF)
6. V_{EE} is the negative equivalent value to V_{DD}



TYPICAL PERFORMANCE GRAPHS

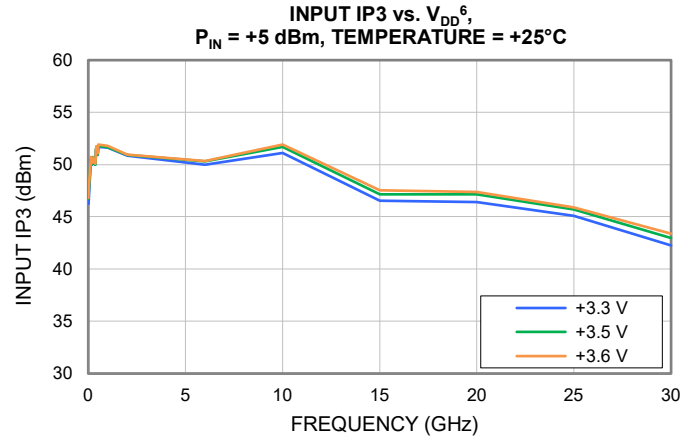
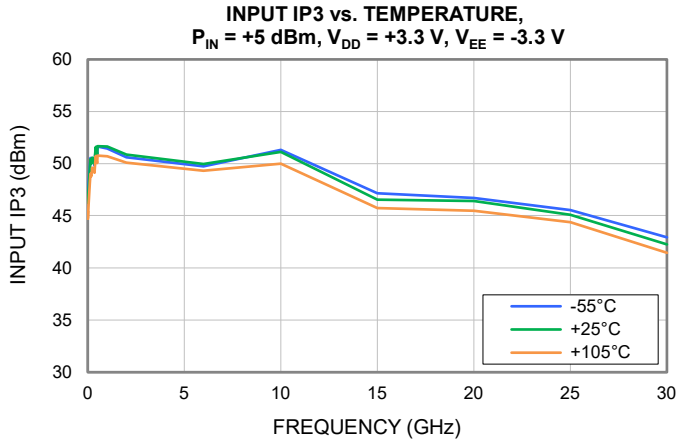

4. RF OUT is defined as either RF1 (ON) or RF2 (ON)
 5. RF OUT is defined as either RF1 (OFF) or RF2 (OFF)
 6. V_{EE} is the negative equivalent value to V_{DD}



MMIC SURFACE MOUNT

SPDT RF Switch

M3SWA2-34DR+

50 Ω DC to 30 GHz Absorptive RF Switch with Internal Driver

ABSOLUTE MAXIMUM RATINGS⁷

Parameter	Ratings
Operating Temperature (ground lead)	-55°C to +105°C
Storage Temperature	-65°C to +150°C
Junction Temperature ⁸	+150°C
Total Power Dissipation	0.43 W
Input Power at RFC (CW), (V _{DD} = +3.5 V, V _{EE} = -3.5 V)	+29 dBm
Input Power at RF1/RF2 (CW), (V _{DD} = +3.5 V, V _{EE} = -3.5 V)	+27 dBm
DC Voltage (V _{DD})	0 V to +5 V
DC Voltage (V _{EE})	-5 V to 0 V

7. Permanent damage may occur if any of these limits are exceeded. Maximum ratings are not intended for continuous normal operation.

8. Peak temperature on top of Die.

THERMAL RESISTANCE

Parameter	Ratings
Thermal Resistance (Θ_{jc}) ⁹	363°C/W

9. Θ_{jc} = (Hot Spot Temperature on Die - Temperature at Ground Lead)/Dissipated Power

ESD RATING

	Class	Voltage Range	Reference Standard
HBM	1A	250 V to < 500 V	ANSI/ESDA/JEDEC JS-001-2017
CDM	C3	≥ 1000 V	JESD22-C101F



ESD HANDLING PRECAUTION: This device is designed to be Class 1A for HBM. Static charges may easily produce potentials higher than this with improper handling and can discharge into DUT and damage it. As a preventive measure Industry standard ESD handling precautions should be used at all times to protect the device from ESD damage.

MSL RATING

Moisture Sensitivity: MSL1 in accordance with IPC/JEDEC J-STD-020E/JEDEC J-STD-033C



FUNCTIONAL DIAGRAM

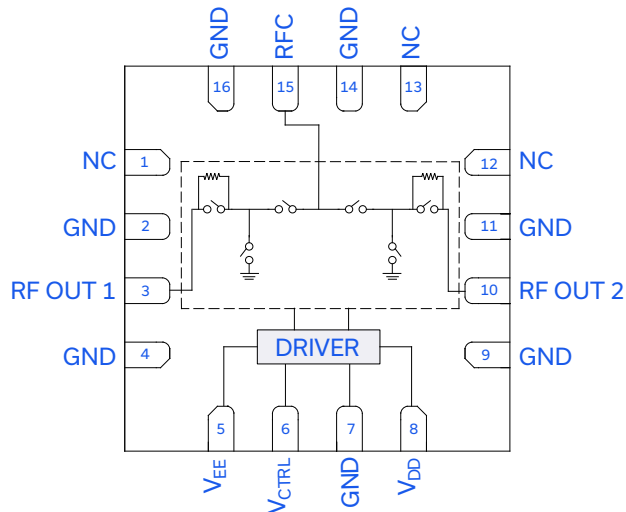

Figure 1. M3SWA2-34DR+ Functional Diagram

PAD DESCRIPTION

Function	Pad Number	Application Description (Refer to Fig 2)
RFC	15	RFC Pad connects to RF Input port.
RF OUT 1	3	RF OUT 1 Pad connects to RF Output port 1.
RF OUT 2	10	RF OUT 2 Pad connects to RF Output port 2.
V _{DD}	8	V _{DD} Pad connects to positive DC Input.
V _{EE}	5	V _{EE} Pad connects to negative DC Input.
V _{CTRL}	6	V _{CTRL} Pad connects to switch control voltage input.
GND	2, 4, 7, 9, 11, 14, 16	Connects to ground.
NC	1, 12, 13	Not used internally. Connected to ground on test board.

CHARACTERIZATION TEST BOARD

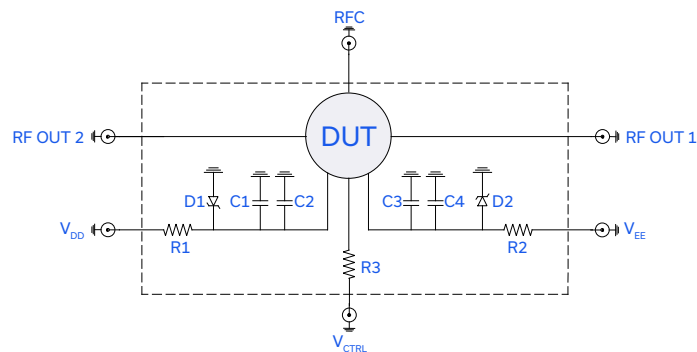

Figure 2. M3SWA2-34DR+ Characterization and Application Circuit

Electrical Parameters and Conditions

Insertion Loss, Isolation, Return Loss, Input Power at 1dB Compression (P1dB), and Input IP3 tested using PNA-X N5247B microwave network analyzer and P5022A vector network analyzer.

Conditions:

1. Insertion Loss, Isolation, and Return Loss: P_{IN} = 0 dBm
2. Input IP3 (IIP3): Two tones, spaced 1 MHz apart, +5 dBm/Tone at input.

Component	Value	Size	Part Number	Manufacturer
C2, C3	100 pF	0402	GRM1555C1H101JAO1D	Murata
C1, C4	0.1 uF	0402	GRM155R71C104KA88D	Murata
R1, R2	11.5 Ω	0402	RP73PF1E11R5BTDF	TE Connectivity
R3	100 Ω	0402	RK73H1ETTP1000F	KOA
D1, D2	V _Z = +5.6 V	SOD-123	SZMMSZ5232BT1G	ON Semiconductor



MMIC SURFACE MOUNT

SPDT RF Switch

M3SWA2-34DR+

Mini-Circuits

50 Ω DC to 30 GHz Absorptive RF Switch with Internal Driver

CASE STYLE DRAWING

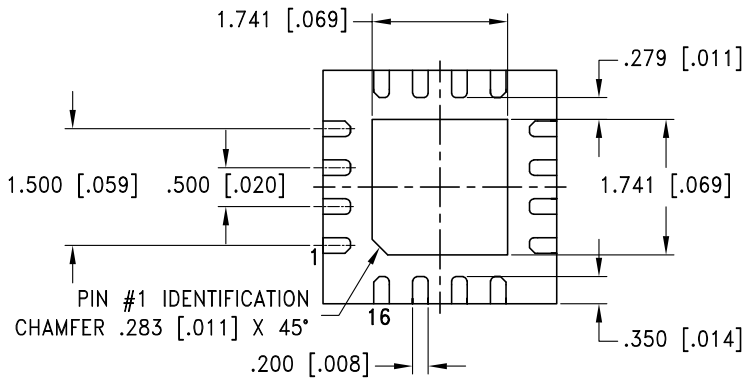
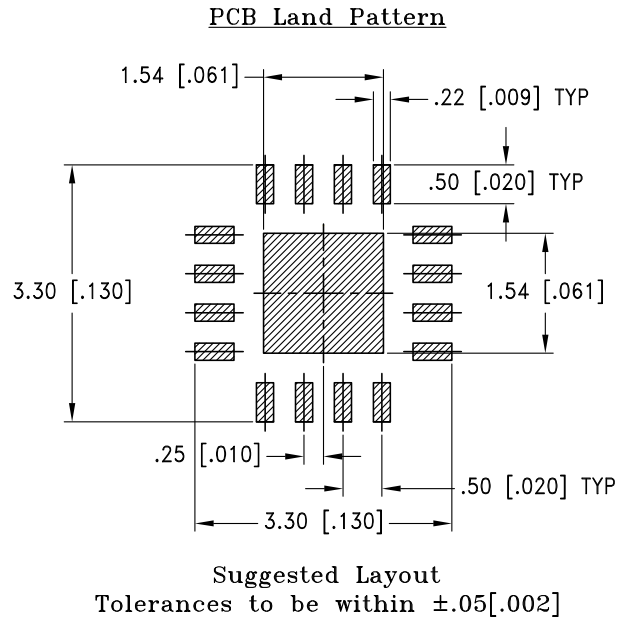
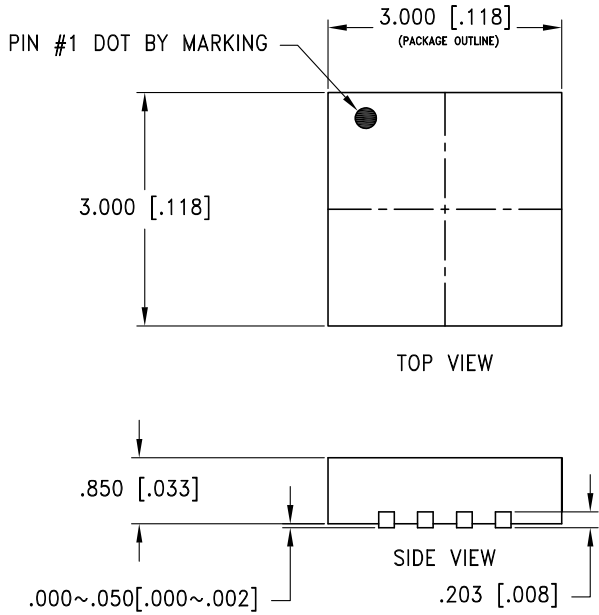

Weight: .02 grams
 Dimensions are in mm [Inches]. Tolerances: 3Pl. ±.05 [.002]

PRODUCT MARKING

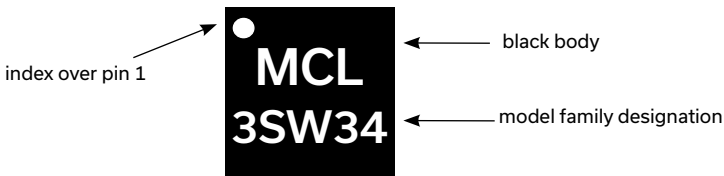

Marking may contain other features or characters for internal lot control





MMIC SURFACE MOUNT

SPDT RF Switch

M3SWA2-34DR+

50 Ω DC to 30 GHz Absorptive RF Switch with Internal Driver

ADDITIONAL DETAILED INFORMATION IS AVAILABLE ON OUR DASH BOARD

[CLICK HERE](#)

Performance Data & Graphs	Data Graphs S-Parameter (S3P Files) Data Set (.zip file)
Case Style	DQ3005. Plastic package, exposed paddle, Lead Finish: Matte-Tin
RoHS Status	Compliant
Tape & Reel Standard quantities available on reel	F104 7" reels with 20, 50, 100, 200, 500, 1000, or 2000 devices
Suggested Layout for PCB Design	PL-768
Evaluation Board	TB-M3SWA234DRC+ Gerber File
Environmental Ratings	ENV08T1

NOTES

- A. Performance and quality attributes and conditions not expressly stated in this specification document are intended to be excluded and do not form a part of this specification document.
- B. Electrical specifications and performance data contained in this specification document are based on Mini-Circuit's applicable established test performance criteria and measurement instructions.
- C. The parts covered by this specification document are subject to Mini-Circuits standard limited warranty and terms and conditions (collectively, "Standard Terms"); Purchasers of this part are entitled to the rights and benefits contained therein. For a full statement of the standard terms and the exclusive rights and remedies thereunder, please visit Mini-Circuits' website at www.minicircuits.com/terms/viewterm.html

