



LOW NOISE, WIDEBAND, HIGH IP3

# Monolithic Amplifier PMA2-153LN+

50Ω 0.5 to 15 GHz

## THE BIG DEAL

- Ultra wideband, 0.5 to 15 GHz
- Flat gain over wideband, 16.7 dB with  $\pm 3.3$  dB
- Low noise figure, 2.6 dB at 8 GHz
- High IP3, up to +28 dBm

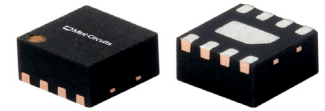

Generic photo used for illustration purposes only

CASE STYLE: MC1631-1

### +RoHS Compliant

The +Suffix identifies RoHS Compliance. See our website for methodologies and qualifications

## APPLICATIONS

- WiFi
- WLAN
- UMTS
- LTE
- WiMAX
- S-band Radar
- C-band Satcom

## PRODUCT OVERVIEW

The PMA2-153LN+ is a PHEMT\* based wideband, low noise, flat gain MMIC amplifier with a unique combination of low noise, high IP3, and flat gain over wideband making it ideal for sensitive, high-dynamic-range receiver applications. This design operates on a single +5V or +6V supply, is well matched for 50Ω and comes in a tiny, low profile package (2 x 2 mm, 8 lead MCLP), accommodating dense circuit board layouts.

## KEY FEATURES

Feature	Advantages
Low noise <ul style="list-style-type: none"> <li>• 2.2 dB at 2 GHz</li> <li>• 2.6 dB at 8 GHz</li> </ul>	Enables lower system noise figure performance.
High IP3 <ul style="list-style-type: none"> <li>• +27.7 dBm at 2 GHz</li> <li>• +26.8 dBm at 8 GHz</li> </ul>	Combination of low noise and high IP3 makes this MMIC amplifier ideal for use in low noise receiver front end (RFE) as it gives the user advantages of sensitivity and two-tone IM performance at both ends of the dynamic range.
Low operating voltage, +5V / +6V.	Achieves high IP3 using low voltage.
2 x 2mm 8-lead MCLP package	Tiny footprint saves space in dense layouts while providing low inductance, repeatable transitions, and excellent thermal contact to the PCB.
Wide bandwidth with flat gain <ul style="list-style-type: none"> <li>• <math>\pm 0.1</math> dB over 0.5 to 2 GHz</li> <li>• <math>\pm 0.7</math> dB over 0.5 to 6 GHz</li> <li>• <math>\pm 1.2</math> dB over 0.5 to 8 GHz</li> <li>• <math>\pm 3.3</math> dB over 0.5 to 15 GHz</li> </ul>	Enables usage in applications without external gain flattening networks.

\*Enhancement mode Pseudomorphic High Electron Mobility Transistor

REV. C  
ECO-011027  
PMA2-153LN+  
RS/CP  
240328





LOW NOISE, WIDEBAND, HIGH IP3

# Monolithic Amplifier PMA2-153LN+

Mini-Circuits

50Ω 0.5 to 15 GHz

## ELECTRICAL SPECIFICATIONS<sup>1</sup> AT +25°C, UNLESS NOTED OTHERWISE

Parameter	Condition (GHz)	V <sub>DD</sub> = +6			V <sub>DD</sub> = +5			Units
		Min.	Typ.	Max.	Min.	Typ.	Max.	
Frequency Range		0.5		15.0	0.5		15.0	GHz
Noise Figure	0.5		2.3			2.2		dB
	2.0		2.3			2.1		
	8.0		2.6			2.5		
	10.0		2.8			2.7		
	15.0		3.8			3.7		
Gain	0.5		19.0			18.1		dB
	2.0		18.9			18.0		
	8.0	15.1	16.8	18.4	14.4	16.0	17.6	
	10.0		16.0			15.3		
	15.0		12.5			11.7		
Input Return Loss	0.5		9.3			8.4		dB
	2.0		10.2			9.2		
	8.0		9.7			9.1		
	10.0		8.7			8.2		
	15.0		4.2			4.2		
Output Return Loss	0.5		13.5			11.7		dB
	2.0		13.0			11.6		
	8.0		22.9			21.0		
	10.0		17.4			17.1		
	15.0		6.9			6.2		
Output Power at 1dB Compression <sup>2</sup>	0.5		+15.3			+14.2		dBm
	2.0		+15.2			+14.0		
	8.0		+14.8			+13.2		
	10.0		+14.8			+13.2		
	15.0		+11.2			+10.5		
Output IP3	0.5		+27.3			+24.7		dBm
	2.0		+27.7			+24.9		
	8.0		+26.8			+24.4		
	10.0		+26.7			+24.7		
	15.0		+24.0			+21.9		
Device Operating Voltage (V <sub>DD</sub> )			+6.0			+5.0		V
Device Operating Current (I <sub>DD</sub> )		—	66	85	—	50	—	mA
Device Current Variation vs. Temperature <sup>3</sup>			-5.3			12.5		μA/°C
Device Current Variation vs. Voltage			0.0187			0.0187		mA/mV
Thermal Resistance, junction-to-ground lead			107			107		°C/W

1. Measured on Mini-Circuits Characterization Test Board MB014-1. See Characterization Test Circuit (Fig. 1)

2. Current increases at P1dB up to 10mA typ. at 5Volts V<sub>DD</sub>

3. (Current at 85°C - Current at -45°C)/130

## ABSOLUTE MAXIMUM RATINGS<sup>3</sup>

Parameter	Ratings
Operating Temperature (ground lead)	-40°C to +85°C
Storage Temperature	-65°C to +150°C
Junction Temperature	+ 160
Total Power Dissipation	0.7 W
Input Power (CW), V <sub>d</sub> =5,6V <sup>5</sup>	+20 dBm (0.7 - 7.75 GHz) 5 minutes max. +22 dBm (7.75 - 15 GHz) 5 minutes max. +8 dBm (continuous)
DC Voltage	+7 V

4. Permanent damage may occur if any of these limits are exceeded. Electrical maximum ratings are not intended for continuous normal operation.

5. Measured on Mini-Circuits Test Board, TB-MB014-1





LOW NOISE, WIDEBAND, HIGH IP3

# Monolithic Amplifier PMA2-153LN+

50Ω 0.5 to 15 GHz

## SIMPLIFIED SCHEMATIC & PAD DESCRIPTION

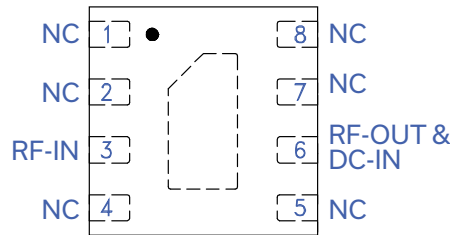
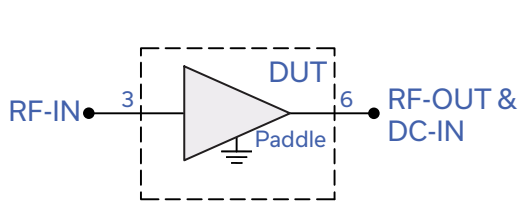

Function	Pad Number	Description (See Figure 2)
RF-IN	3	Connects to RF input via C1
RF-OUT & DC-IN	6	Connects to RF out and V <sub>DD</sub> via Bias-Tee
Ground	Paddle	Connects to ground
No Connection	1,8	Not used internally. Connected to ground on Test Board
No Connection	2,4	Not used internally. Connected to RF-IN on Test Board
No Connection	5,7	Not used internally. Connected to RF-OUT & DC-IN on Test Board

## CHARACTERIZATION TEST CIRCUIT

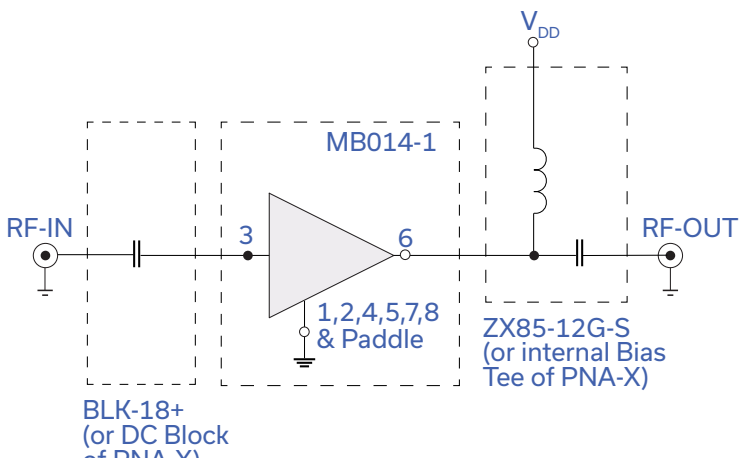

Fig 1. Characterization Circuit

Note: This block diagram is used for characterization. (DUT soldered on Mini-Circuits Characterization test board TB-MB014-1)

Gain, Return loss, Output power at 1dB compression (P1 dB), output IP3 (OIP3) and noise figure measured using Agilent's N5242A PNA-X microwave network analyzer.

Conditions:

1. Gain and Return loss: Pin= -25dBm
2. Output IP3 (OIP3): Two tones, spaced 1 MHz apart, 0 dBm/tone at output.



LOW NOISE, WIDEBAND, HIGH IP3

# Monolithic Amplifier **PMA2-153LN+**

50Ω 0.5 to 15 GHz

## RECOMMENDED APPLICATION CIRCUIT

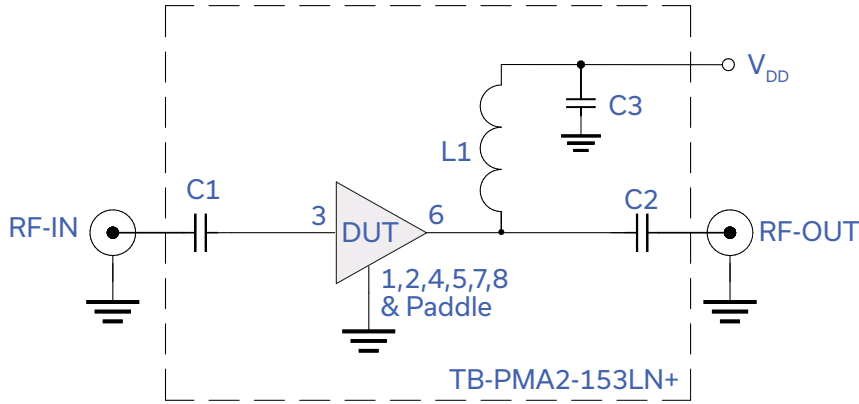
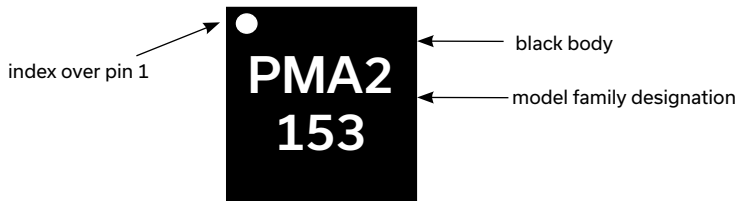

Fig 2. Application Circuit

Component	Size	Value	Part Number	Manufacturer
C1, C2, C3	0402	0.1 uF	LBB0402X104MGT1C8	Presidio Component INC.
L1	0.11 x 0.05	0.84 uH	CC45T47K240G5-C2	Piconics INC.

## PRODUCT MARKING



Marking may contain other features or characters for internal lot control



LOW NOISE, WIDEBAND, HIGH IP3

# Monolithic Amplifier PMA2-153LN+

50Ω 0.5 to 15 GHz

ADDITIONAL DETAILED TECHNICAL INFORMATION IS AVAILABLE ON OUR DASH BOARD. TO ACCESS [CLICK HERE](#)

Performance Data	Data Table
	Swept Graphs
	S-Parameter (S2P Files) Data Set (.zip file)
Case Style	MC1631-1 Plastic package, exposed paddle, lead finish: Matte-Tin
Tape & Reel	F66
Standard quantities available on reel	7" reels with 20, 50, 100, 200, 500, 1K, 2K or 3K devices
Suggested Layout for PCB Design	PL-496
Evaluation Board	TB-PMA2-153LN+
Environmental Ratings	ENV08T1

### ESD RATING

Human Body Model (HBM): Class 1A (250 to <500V) in accordance with ANSI/ESD STM 5.1 - 2001

### MSL RATING

Moisture Sensitivity: MSL1 in accordance with IPC/JEDEC J-STD-020D

### MSL TEST FLOW CHART

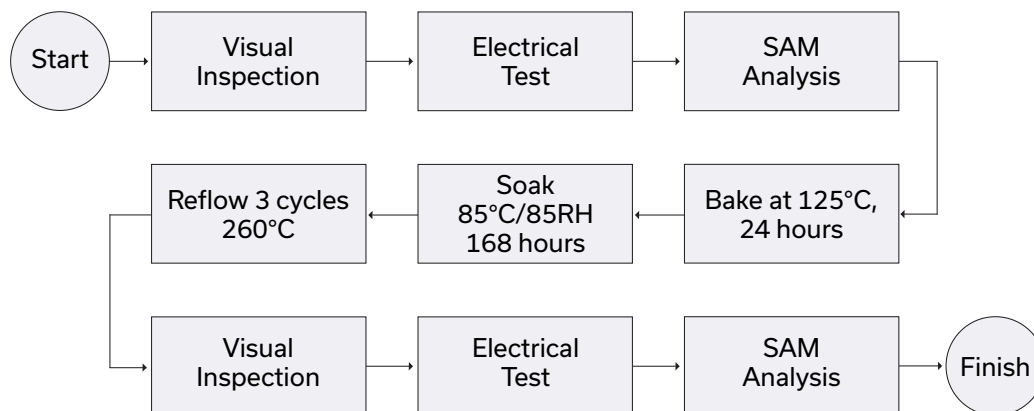

- NOTES**
- A. Performance and quality attributes and conditions not expressly stated in this specification document are intended to be excluded and do not form a part of this specification document.
  - B. Electrical specifications and performance data contained in this specification document are based on Mini-Circuit's applicable established test performance criteria and measurement instructions.
  - C. The parts covered by this specification document are subject to Mini-Circuits standard limited warranty and terms and conditions (collectively, "Standard Terms"); Purchasers of this part are entitled to the rights and benefits contained therein. For a full statement of the standard. Terms and the exclusive rights and remedies thereunder, please visit Mini-Circuits' website at [www.minicircuits.com/MCLStore/terms.jsp](http://www.minicircuits.com/MCLStore/terms.jsp)

