

Low Noise, Wideband, High IP3 Monolithic Amplifier Die

PMA3-83LN-D+

50Ω 0.5 to 8.0 GHz

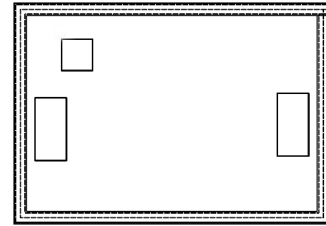

The Big Deal

- Flat gain over wideband
- Low noise figure, 1.2 dB
- High IP3, up to +37 dBm

Product Overview

The PMA3-83LN-D+ is a PHEMT based wideband, low noise MMIC amplifier die with a unique combination of low noise, high IP3, and flat gain over wideband making it ideal for sensitive, high-dynamic-range receiver applications. This design operates on a single 5V or 6V supply and is well matched to 50Ω.

Key Features

Feature	Advantages
Low noise, 1.2 dB at 2 GHz	Enables lower system noise figure performance.
High IP3 <ul style="list-style-type: none">• +36.8 dBm at 2 GHz and 6V• +29.9 dBm at 8 GHz and 6V	Combination of low noise and high IP3 makes this MMIC amplifier ideal for use in low noise receiver front end (RFE) as it gives the user advantages of sensitivity and two-tone IM performance at both ends of the dynamic range.
Low operating voltage, 5V/6V.	Achieves high IP3 using low voltage.
Wide bandwidth with flat gain <ul style="list-style-type: none">• ±0.9 dB over 0.5 to 7 GHz• ±1.2 dB over 0.5 to 8 GHz	Enables a single amplifier to be used in many wideband applications including defense, instrumentation and more.
Unpackaged Die	Enables users to integrate amplifiers directly into hybrids



Low Noise, Wideband, High IP3 Monolithic Amplifier Die

PMA3-83LN-D+

50Ω 0.5 to 8.0 GHz

Product Features

- Low Noise figure, 1.2 dB at 2 GHz
- High IP3, 35 dBm typ. at 2 GHz
- High Pout, P1dB 20.7 dBm typ. at 2 GHz and 6V
- Excellent Gain flatness, ±0.9 dB over 0.5 to 7 GHz and 6V

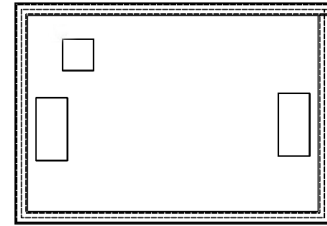

Typical Applications

- WiFi
- WLAN
- UMTS
- LTE
- WiMAX
- S-band Radar
- C-band Satcom

+RoHS Compliant
The +Suffix identifies RoHS Compliance. See our web site for RoHS Compliance methodologies and qualifications

Ordering Information: Refer to Last Page

General Description

The PMA3-83LN-D+ is a PHEMT based wideband, low noise MMIC amplifier die with a unique combination of low noise, high IP3, and flat gain over wideband making it ideal for sensitive, high-dynamic-range receiver applications. This design operates on a single 5V or 6V supply and is well matched to 50Ω.

Simplified Schematic and Pad description

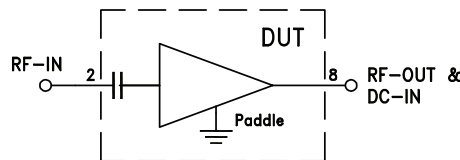

Function	Description (See Figure 1)
RF-IN	Connects to RF input and to ground via L1 (optional blocking capacitor of 100pF may be used)
RF-OUT & DC-IN	Connects to RF out via C3 and V _{DD} via L2
Ground	Bottom of die

Note: 1. Bond Pad material - Gold
2. Bottom of Die - Gold plated

Electrical Specifications¹ at 25°C and 5V, unless noted

Parameter	Condition (GHz)	V _{DD} =6.0			V _{DD} =5.0	Units
		Min.	Typ.	Max.	Typ.	
Frequency range		0.5		8.0	0.5-8.0	GHz
Noise figure	0.5		1.8		1.8	dB
	2.0		1.2		1.2	
	4.0		1.3		1.4	
	8.0		1.6		1.7	
Gain	0.5		21.7		20.8	dB
	2.0		21.9		21.1	
	4.0		21.4		20.6	
	8.0		19.8		19.3	
Input return loss	0.5		14.5		13.3	dB
	2.0		15.6		16.4	
	4.0		12.7		11.8	
	8.0		8.1		7.8	
Output return loss	0.5		12.4		13.5	dB
	2.0		10.8		12.0	
	4.0		20.9		23.9	
	8.0		11.0		10.7	
Output power at 1dB compression ²	0.5		18.6		16.1	dBm
	2.0		21.2		19.6	
	4.0		19.0		16.9	
	8.0		17.7		16.7	
Output IP3	0.5		34.7		29.6	dBm
	2.0		36.8		30.5	
	4.0		32.5		27.8	
	8.0		29.9		26.7	
Device operating voltage (V _{DD})		—	6.0	—	5.0	V
Device operating current (I _{DD})		—	77	94	60	mA
Device current variation vs. voltage			0.016		0.019	mA/mV
Thermal resistance, junction-to-ground lead			40		40	°C/W

1. Measured on Mini-Circuits Characterization test board. See Characterization Test Circuit (Fig. 1)

2. Current increases at P1dB to 109 mA typ. at +6V V_{DD} and 88mA typ. at +5V V_{DD}

Absolute Maximum Ratings^{3,4}

Parameter	Ratings
Operating Temperature	-40°C to 85°C
Junction Temperature	150°C
Total Power Dissipation	0.95 W
Input Power (CW), V _d =5,6V	+19 dBm (5 minutes max.) +16 dBm (continuous)
DC Voltage	7 V

3. Permanent damage may occur if any of these limits are exceeded.

Electrical maximum ratings are not intended for continuous normal operation.

4. Die performance measured in industry standard 3x3 mm 12-lead MCLP package.

Recommended Application and Characterization Test Circuit

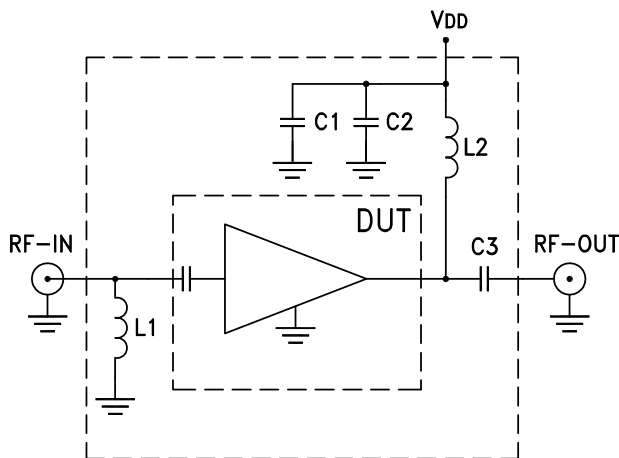

Component	Value	Size
C1	0.01 μ F	0402
C2	10pF	0402
C3	100pF	0402
L1	18nH	0402
L2	39nH	0402

Fig 1. Application and Characterization circuit
Gain, Return loss, Output power at 1dB compression (P1 dB), output IP3 (OIP3) and noise figure measured using Keysight's N5242A PNA-X microwave network analyzer.

- Conditions:
1. Gain and Return loss: Pin= -25dBm
 2. Output IP3 (OIP3): Two tones, spaced 1 MHz apart, 0 dBm/tone at output.

Die Layout

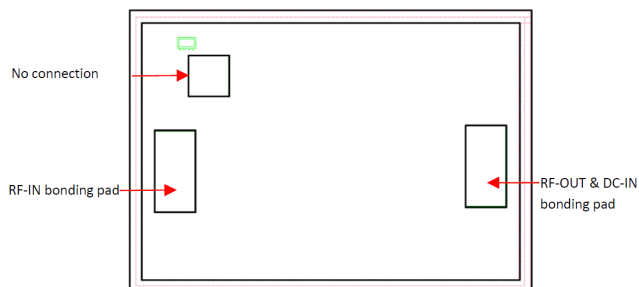

Fig 2. Die Layout

Bonding Pad Position
(Dimensions in μ m, Typical)

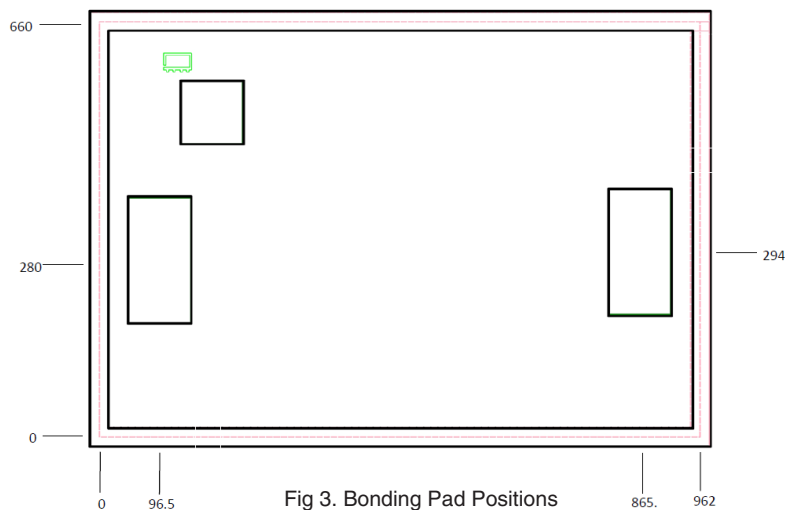

Fig 3. Bonding Pad Positions

Critical Dimensions

Parameter	Values
Die Thickness, μ m	100
Die Width, μ m	660
Die Length, μ m	962
Bond Pad Size, μ m	100 X 200

Assembly and Handling Procedure

1. Storage
Dice should be stored in a dry nitrogen purged desiccators or equivalent.
2. ESD
MMIC Gallium Arsenide (GaAs) amplifier dice are susceptible to electrostatic and mechanical damage. Die are supplied in antistatic protected material, which should be opened in clean room conditions at an appropriately grounded anti-static workstation. Devices need careful handling using correctly designed collets, vacuum pickup tips or sharp antistatic tweezers to deter ESD damage to dice.
3. Die Attach
The die mounting surface must be clean and flat. Using conductive silver filled epoxy, recommended epoxies are DieMat DM6030HK-PT/H579 or Ablestik 84-1LMISR4. Apply sufficient epoxy to meet required epoxy bond line thickness, epoxy fillet height and epoxy coverage around total die periphery. Parts shall be cured in a nitrogen filled atmosphere per manufacturer's cure condition. It is recommended to use antistatic die pick up tools only.
4. Wire Bonding
Bond pad openings in the surface passivation above the bond pads are provided to allow wire bonding to the dice gold bond pads. Thermosonic bonding is used with minimized ultrasonic content. Bond force, time, ultrasonic power and temperature are all critical parameters. Suggested wire is pure gold, 1 mil diameter. Bonds must be made from the bond pads on the die to the package or substrate. All bond wires should be kept as short as low as reasonable to minimize performance degradation due to undesirable series inductance.

Assembly Diagram

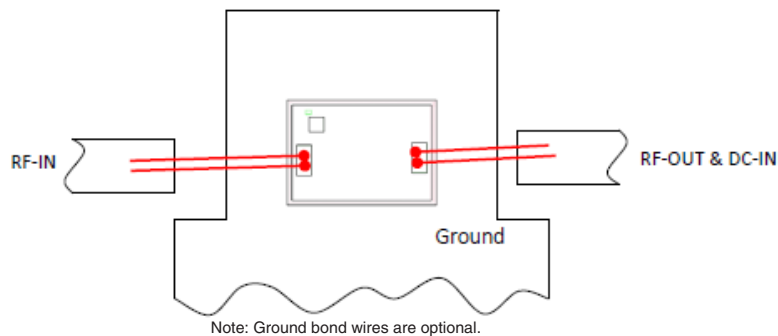

Recommended Wire Length, Typical

Wire	Wire Length (mm)	Wire Loop Height (mm)
RF-IN	0.5	0.15
RF-OUT & DC IN	0.5	0.15

RF Reference Plane - No port extension

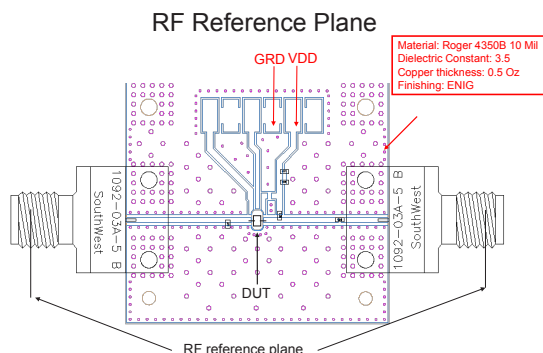

Additional Detailed Technical Information <i>additional information is available on our dash board.</i>	
Performance Data	Data Table
	Swept Graphs
	S-Parameter (S2P Files) Data Set with and without port extension(.zip file)
Case Style	Die
Die Ordering and packaging information	Quantity, Package Model No.
	Small, Gel - Pak: 5,10,50,100 KGD* PMA3-83LN-DG+ Medium†, Partial wafer: KGD*<1910 PMA3-83LN-DP+ Large†, Full Wafer PMA3-83LN-DF+
	†Available upon request contact sales representative
	Refer to AN-60-067
Environmental Ratings	ENV-80

*Known Good Dice ("KGD") means that the dice in question have been subjected to Mini-Circuits DC test performance criteria and measurement instructions and that the parametric data of such dice fall within a predefined range. While DC testing is not definitive, it does help to provide a higher degree of confidence that dice are capable of meeting typical RF electrical parameters specified by Mini-Circuits.

ESD Rating**

Human Body Model (HBM): Class 1A (250 to <500V) in accordance with ANSI/ESD STM 5.1 - 2001

** Tested in industry standard 12-lead, 3x3 mm MCLP package.

Additional Notes

- A. Performance and quality attributes and conditions not expressly stated in this specification document are intended to be excluded and do not form a part of this specification document.
- B. Electrical specifications and performance data contained in this specification document are based on Mini-Circuit's applicable established test performance criteria and measurement instructions.
- C. The parts covered by this specification document are subject to Mini-Circuits standard limited warranty and terms and conditions (collectively, "Standard Terms"); Purchasers of this part are entitled to the rights and benefits contained therein. For a full statement of the Standard Terms and the exclusive rights and remedies thereunder, please visit Mini-Circuits' website at www.minicircuits.com/MCLStore/terms.jsp
- D. Mini-Circuits does not warrant the accuracy or completeness of the information, text, graphics and other items contained within this document and same are provided as an accommodation and on an "As is" basis, with all faults.
- E. Purchasers of this part are solely responsible for proper storing, handling, assembly and processing of Known Good Dice (including, without limitation, proper ESD preventative measures, die preparation, die attach, wire bonding and related assembly and test activities), and Mini-Circuits assumes no responsibility therefor or for environmental effects on Known Good Dice.
- F. Mini-Circuits and the Mini-Circuits logo are registered trademarks of Scientific Components Corporation d/b/a Mini-Circuits. All other third-party trademarks are the property of their respective owners. A reference to any third-party trademark does not constitute or imply any endorsement, affiliation, sponsorship, or recommendation by any such third-party of Mini-Circuits or its products.