



USB & ETHERNET CONTROLLED

# RF Transfer Switch Matrix **RC-2MTS-18**

Mini-Circuits

50Ω DC to 18 GHz SMA-Female

## THE BIG DEAL

- Dual mechanical transfer switches
- High reliability, 10 million switch cycles
- 10W power rating (cold switching)
- High isolation, 85 dB typ.

## APPLICATIONS

- Automated test equipment
- Fail-safe / redundancy switching
- Switch matrices



CASE STYLE: SH2618

[DOWNLOAD](#)

SOFTWARE PACKAGE

**RoHS Compliant**

See our website for RoHS Compliance methodologies and qualifications

## RACK-MOUNT SWITCH SYSTEMS AVAILABLE



[SEE PAGE 8](#)

## PRODUCT OVERVIEW

Mini-Circuits' RC-2MTS-18 comprises a pair of independently controlled, electro-mechanical transfer switches. Each switch operates over a wide bandwidth, from DC to 18 GHz with high isolation (85 dB typical), low insertion loss (0.2 dB typical) and high input power rating (10W for cold switching). The switches are of a fail-safe and break-before-make-configuration using a patented design which ensures long-term reliability, with a minimum lifetime of 10 million switching cycles when used within the noted specifications.

The switch box is constructed in a compact, rugged metal case (4.5 x 6.0 x 2.25") with 8 SMA (f) RF connectors on the front panel. The switches are controlled via USB or Ethernet, allowing control directly from a PC, or remotely over a network. Full software support is provided, including our user-friendly GUI application for Windows and a full API with programming instructions for Windows and Linux environments (both 32-bit and 64-bit systems).

## KEY FEATURES

Feature	Advantages
Dual transfer switches	Transfer switches provide a simple DPDT switch application (2 input to 2 output switch matrix) and are a useful building block in much larger switch matrices
Fail-safe design	The switches revert to a known default state when the DC supply is removed, allowing their use in systems that must continue to operate safely in the event of power failure
Break-before-make configuration	Prevents a momentary connection of the old and new signal paths, reducing the inconsistent transient effects that could otherwise be observed during switching
USB & Ethernet control	USB HID and Ethernet (HTTP / Telnet) interfaces provide easy compatibility with a wide range of software setups and programming environments
Full software support	User friendly Windows GUI (graphical user interface) allows manual control straight out of the box, while the comprehensive API (application programming interface) with examples and instructions allows easy automation in most programming environments





USB & ETHERNET CONTROLLED

# RF Transfer Switch Matrix **RC-2MTS-18**

Mini-Circuits

50Ω DC to 18 GHz SMA-Female

## ELECTRICAL SPECIFICATIONS AT 25°C

Parameter	Conditions	Min.	Typ.	Max.	Units
Frequency Range		DC		18	GHz
Insertion Loss	DC - 1	—	0.10	0.15	dB
	1 - 8	—	0.10	0.25	
	8 - 12	—	0.20	0.36	
	12 - 18	—	0.25	0.45	
Isolation	DC - 1	85	100	—	dB
	1 - 8	75	90	—	
	8 - 12	70	86	—	
	12 - 18	60	76	—	
VSWR	DC - 1	—	1.05	—	:1
	1 - 8	—	1.15	—	
	8 - 12	—	1.15	—	
	12 - 18	—	1.15	—	
Switching Time	—	—	25	—	ms
RF Input Power <sup>1</sup>	Cold switching	—	—	10	W
Switch Lifetime (per Switch)	<0.1W hot switching <sup>2</sup>	10	—	—	million cycles
	0.1 - 1W hot switching	—	3	—	
Rated Voltage	24V <sub>DC</sub> input	23	24	25	V
	USB port	—	5	—	
Rated Current (24V DC Input)	Both switches in state 2	—	440	610	mA
	Both switches in state 1	—	90	120	
Rated Current (USB)		—	10	20	mA

1. Maximum power for cold switching is 10W per path, 20W total, with all port terminate into 50Ω  
 2. Hot switching power above this level will degrade the switch lifetime.

## ABSOLUTE MAXIMUM RATINGS

Parameters	Ratings
Total RF Power	20W <sup>1</sup>
Operating Temperature	0°C to 40°C
Storage Temperature	-15°C to 85°C
Supply Voltage	26V





USB & ETHERNET CONTROLLED

# RF Transfer Switch Matrix RC-2MTS-18

Mini-Circuits

50Ω DC to 18 GHz SMA-Female

## SWITCHING STATES (PER SWITCH)



## CONNECTIONS

Port Name	Connector Type
RF Switch A (J1, J2, J3 & J4)	SMA female
RF Switch B (J1, J2, J3 & J4)	SMA female
USB	USB type-B
Ethernet / LAN	RJ45
24V <sub>DC</sub> Input	2.1mm center positive DC socket

## OUTLINE DRAWING (SH2618)

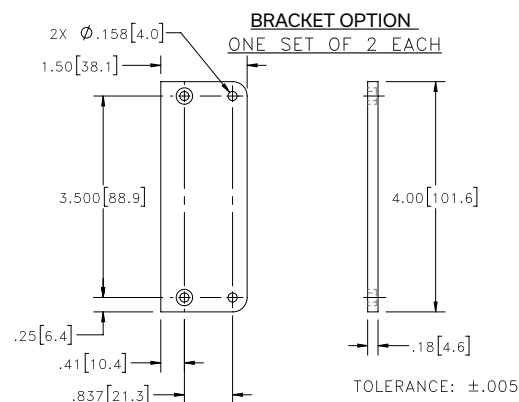
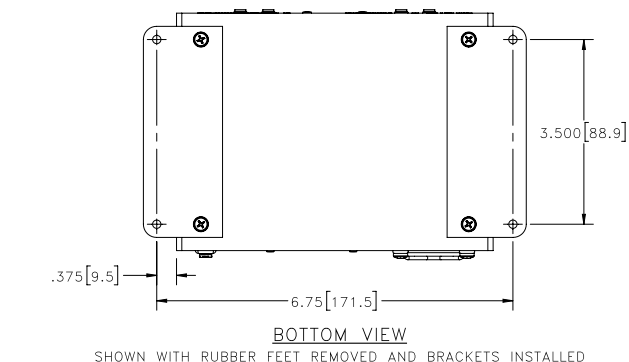
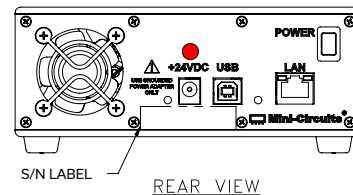
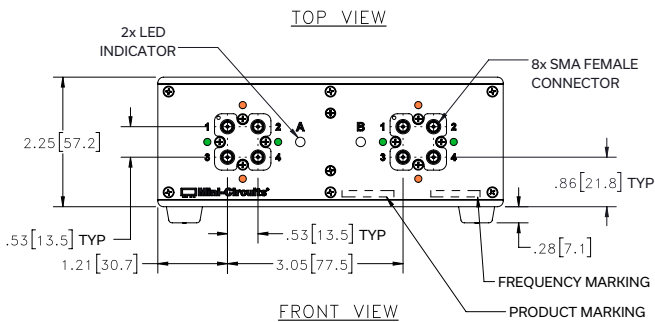
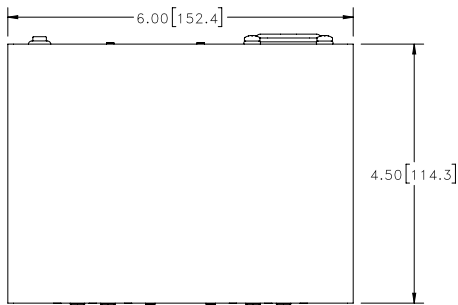

**INSTRUCTIONS FOR MOUNTING**  
 BRACKETS:  
 TOOL REQUIRED: PHILLIPS HEAD SCREWDRIVER  
 STEP 1: REMOVE RUBBER FEET FROM THE BOTTOM OF THE UNIT, DO NOT DISCARD THE FASTENERS.  
 STEP 2: MOUNT THE BRACKETS WITH THE FASTENERS REMOVED IN STEP 1, USING THE COUNTER BORE HOLES IN THE BRACKET.

Weight: 920 grams  
 Dimensions are in inches [mm]. Tolerances: 2 Pl. ±.03 inch; 3Pl. ±.015 inch





USB & ETHERNET CONTROLLED

# RF Transfer Switch Matrix RC-2MTS-18

Mini-Circuits

50Ω DC to 18 GHz SMA-Female

### TYPICAL PERFORMANCE DATA (PER SWITCH)

FREQ. (MHz)	ON INSERTION LOSS (dB)		OFF ISOLATION (dB)		VSWR (:1)			
	J1-J2	J1-J3	J1-J2	J1-J3	State 2		State 1	
					J1	J2	J1	J2
10.00	0.01	0.01	90.66	94.50	1.00	1.00	1.00	1.00
100.00	0.01	0.01	94.93	100.05	1.00	1.00	1.00	1.00
500.00	0.03	0.03	92.59	100.93	1.01	1.01	1.01	1.01
700.00	0.03	0.03	108.21	91.48	1.01	1.01	1.01	1.01
800.00	0.04	0.04	92.52	102.45	1.01	1.01	1.01	1.01
1000.00	0.04	0.04	92.45	100.96	1.01	1.01	1.01	1.01
2000.00	0.06	0.06	100.79	97.34	1.01	1.02	1.01	1.01
3000.00	0.07	0.07	93.32	102.92	1.05	1.05	1.04	1.04
4000.00	0.08	0.08	95.89	93.03	1.07	1.09	1.06	1.06
5000.00	0.10	0.09	95.75	90.70	1.08	1.10	1.07	1.07
6000.00	0.11	0.10	100.15	94.32	1.08	1.12	1.08	1.09
7000.00	0.11	0.11	89.08	99.96	1.04	1.08	1.05	1.05
8000.00	0.12	0.12	94.59	91.64	1.04	1.02	1.02	1.02
9000.00	0.14	0.14	102.19	93.50	1.11	1.09	1.10	1.10
10000.00	0.16	0.16	95.10	95.63	1.16	1.13	1.14	1.14
11000.00	0.17	0.16	95.14	88.79	1.14	1.12	1.12	1.11
12000.00	0.16	0.16	87.77	87.85	1.09	1.08	1.09	1.08
14000.00	0.18	0.17	93.24	98.95	1.04	1.04	1.02	1.01
16000.00	0.21	0.20	84.54	82.94	1.08	1.02	1.05	1.06
18000.00	0.25	0.21	81.87	88.03	1.20	1.08	1.16	1.14

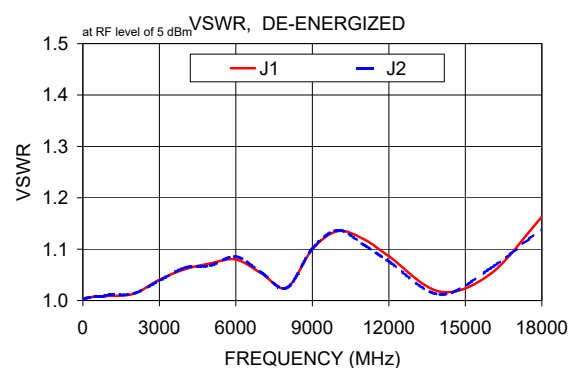
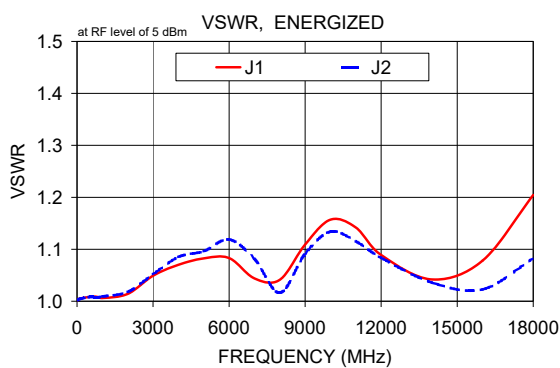
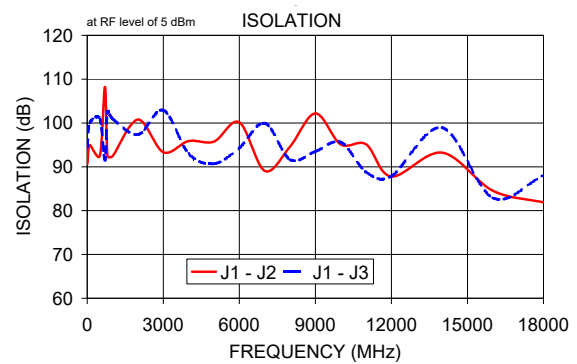
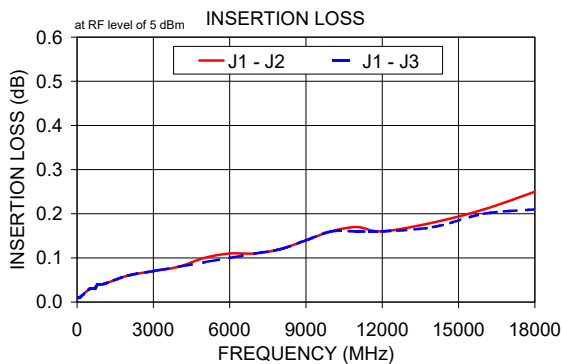



## USB & ETHERNET CONTROLLED

# RF Transfer Switch Matrix **RC-2MTS-18**

Mini-Circuits

50Ω DC to 18 GHz SMA-Female

### SOFTWARE SPECIFICATIONS

#### SOFTWARE & DOCUMENTATION DOWNLOAD:

- Mini-Circuits' full software and support package including user guide, Windows GUI, DLL files, programming manual and examples can be downloaded free of charge from: <https://www.minicircuits.com/softwaredownload/rfswitchcontroller.html>
- Please contact [testsolutions@minicircuits.com](mailto:testsolutions@minicircuits.com) for support

#### MINIMUM SYSTEM REQUIREMENTS:

Parameter	Requirements	
Interface	USB HID & Ethernet (HTTP & Telnet)	
System Requirements	GUI	Windows 98 or later
	USB API DLL	Windows 98 or later and programming environment with ActiveX or .NET support
	USB Direct Programming	Linux, Windows 98 or later
	Ethernet	Windows, Linux or Mac computer with a network port and Ethernet TCP/IP support
Hardware	Pentium II or later with 256 MB RAM	

#### APPLICATION PROGRAMMING INTERFACE (API)

##### ETHERNET SUPPORT:

- Simple ASCII / SCPI command set for attenuator control
- Communication via HTTP or Telnet
- Supported by most common programming environment

##### USB SUPPORT (WINDOWS):

- ActiveX COM DLL file for creation of 32-bit programs
- .NET library DLL file for creation of 32 / 64-bit programs
- Supported by most common programming environments (refer to application note AN-49-001 for summary of supported environments)

##### USB SUPPORT (LINUX):

- Direct USB programming using a series of USB interrupt codes

Full programming instructions and examples available for a wide range of programming environments / languages.



### GRAPHICAL USER INTERFACE (GUI) FOR WINDOWS - KEY FEATURES

- Connect via USB or Ethernet
- Run GUI in "demo mode" to evaluate software without a hardware connection

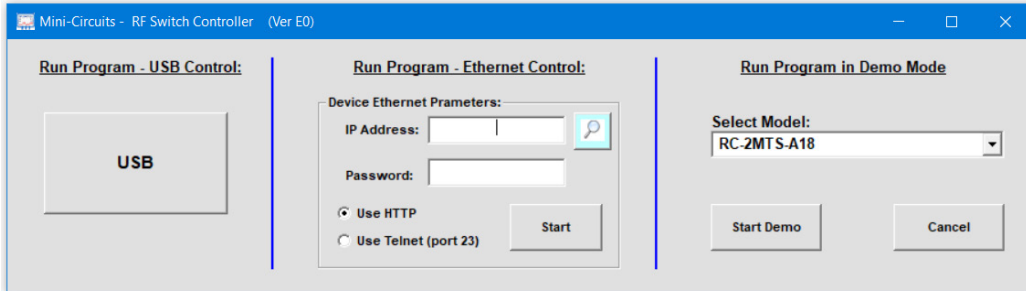

- View and set switch states at the click of a button
- Configure and run timed switching sequences
- Set start-up switch state
- Configure Ethernet IP settings

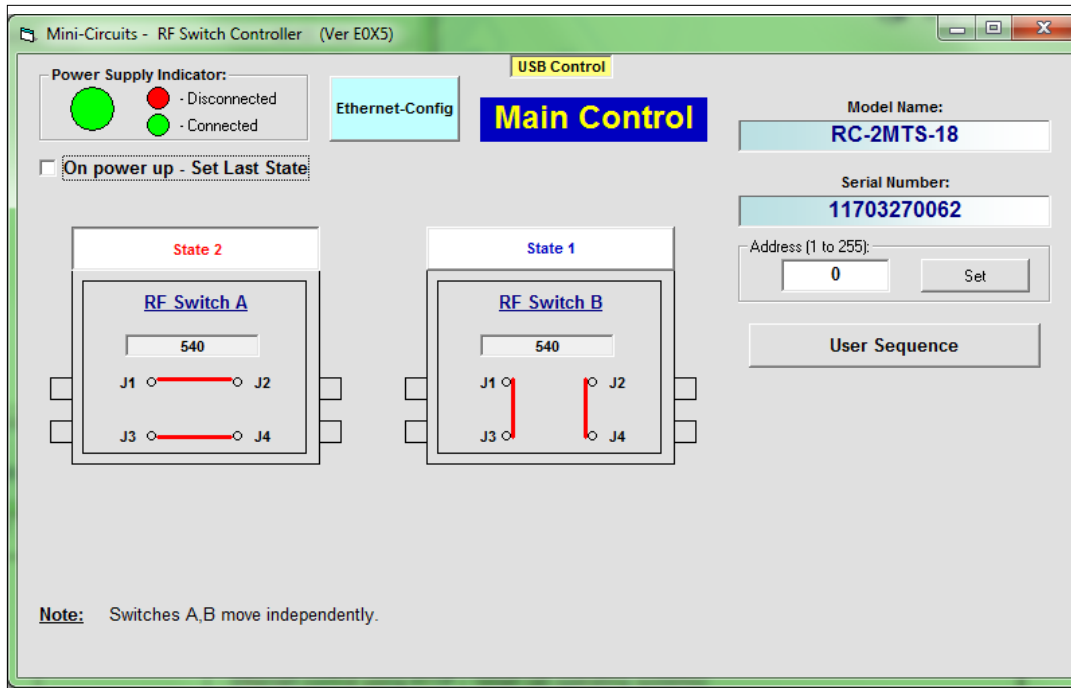



## USB & ETHERNET CONTROLLED

# RF Transfer Switch Matrix **RC-2MTS-18**





50Ω DC to 18 GHz SMA-Female





### ORDERING INFORMATION

Refer to Mini-Circuits' website for pricing and availability information:

<https://www.minicircuits.com/WebStore/dashboard.html?model=RC-2MTS-18>

Model	Description
RC-2MTS-18	USB & Ethernet controlled transfer switch matrix

Included Accessories	Part No.	Description
	AC/DC-24-3W1	AC/DC 24V <sub>DC</sub> Grounded Power Adaptor. Operating temperature: 0°C to +40°C, I <sub>Max</sub> =2.5A
See Below	CBL-3W1-XX	AC Power Cord (Select one power cord from below with each Switch Matrix box)
	USB-CBL-AB-3+	2.7 ft (0.8 m) USB Cable: USB type A(Male) to USB type B(Male)

AC Power Cords <sup>5</sup>	Part No.	Description
	CBL-3W1-US	Power Cord for United States
	CBL-3W1-EU	Power Cord for Europe
	CBL-3W1-UK	Power Cord for United Kingdom
	CBL-3W1-AU	Power Cord for Australia and China
	CBL-3W1-IL	Power Cord for Israel

<sup>5</sup> If you need a Power cord for a country not listed please contact [testsolutions@minicircuits.com](mailto:testsolutions@minicircuits.com)

### OPTIONAL ACCESSORIES

USB-CBL-AB-3+	2.7 ft (0.8 m) USB Cable: USB type A(Male) to USB type B(Male)
USB-CBL-AB-7+	6.8 ft (2.1 m) USB Cable: USB type A(Male) to USB type B(Male)
USB-CBL-AB-11+	11 ft (3.4 m) USB Cable: USB type A(Male) to USB type B(Male)
CBL-RJ45-MM-5+	5 ft (1.5 m) Ethernet cable: RJ45(Male) to RJ45(Male) Cat 5E cable
BKT-272-08+	Bracket (One set of 2 each)





USB & ETHERNET CONTROLLED

# RF Transfer Switch Matrix **RC-2MTS-18**

Mini-Circuits

50Ω DC to 18 GHz SMA-Female

## ALTERNATIVE MODELS

Mini-Circuits has a number of options for larger switching systems comprising more than 2 transfer switches, or combinations of switch types. Please contact [testsolutions@minicircuits.com](mailto:testsolutions@minicircuits.com) with your requirements.



## ZTM SERIES

The ZTM Series test platform contains 6 customizable windows on the front panel, each of which can be populated with your choice of switch or programmable attenuator components:

- Up to two SPDT mechanical switches (DC to 18 GHz) per window
- Up to two mechanical transfer switches (DC to 18 GHz) per window
- One SP4T mechanical switch (DC to 18 GHz) per window
- One SP6T mechanical switch (DC to 12 GHz) per window
- Up to two programmable attenuators (0 to 30, 60, 90, 110, and 120 dB) per window

All combinations shipped within 2-3 weeks of an order!

Please see <https://www.minicircuits.com/WebStore/ztm.html> for more details.



## RCM-200 SERIES

The RCM-200 series modular test systems offer flexibility and fast turnaround for compact test setups. The design consists of a small, light-weight chassis with up to three open hardware windows, each of which may be outfitted with your choice of programmable attenuators or switches. A wide range of switch options are available for shipment within 2-3 weeks of an order:

- 6 mechanical SPDT or transfer (DC-18 GHz) switches
- 3 mechanical SP4T (DC-18 GHz) or SP6T (DC-12 GHz) switches
- 2 mechanical SP8T switches (DC-12 GHz)
- Custom combinations of SPDT, SP4T, SP6T and transfer switches

Please see <https://www.minicircuits.com/WebStore/rcm.html> for more details.

- NOTES**
- Performance and quality attributes and conditions not expressly stated in this specification document are intended to be excluded and do not form a part of this specification document.
  - Electrical specifications and performance data contained in this specification document are based on Mini-Circuit's applicable established test performance criteria and measurement instructions.
  - The parts covered by this specification document are subject to Mini-Circuits standard limited warranty and terms and conditions (collectively, "Standard Terms"); Purchasers of this part are entitled to the rights and benefits contained therein. For a full statement of the standard. Terms and the exclusive rights and remedies thereunder, please visit Mini-Circuits' website at [www.minicircuits.com/MCLStore/terms.jsp](http://www.minicircuits.com/MCLStore/terms.jsp)

