



USB & ETHERNET CONTROLLED

Millimeter Switch Matrix RC-2SP6T-40R

50Ω DC to 40 GHz 2.92mm-Female

THE BIG DEAL

- Millimeter wave switching (up to 40 GHz)
- 2 x mechanical reflective SP6T switches
- High reliability, 2 million switch cycles
- 5W power rating (cold switching)

APPLICATIONS

- 5G node / device testing
- Automated test equipment
- Fail-safe / redundancy switching

PRODUCT OVERVIEW

Mini-Circuits' RC-2SP6T-40R comprises a pair of independently controlled, electro-mechanical SP6T switches. Each switch operates over an extremely wide bandwidth, from DC to 40 GHz with high isolation and low insertion loss. The reflective switches are of a failsafe and break-before-make-configuration, with a minimum lifetime of 2 million switching cycles per switch position, when used within the noted specifications.

The switch box is constructed in a compact, rugged metal case (5.5 x 6.0 x 2.75") with 14 2.92 mm (f) RF connectors on the front panel. The switches are controlled via USB or Ethernet, allowing control directly from a PC, or remotely over a network. Full software support is provided, including our user-friendly GUI application for Windows and a full API with programming instructions for Windows and Linux environments (both 32-bit and 64-bit systems).

KEY FEATURES

| Feature | Advantages |
|---------------------------------|--|
| Dual mechanical SP6T switches | Mechanical reflective switches provide high reliability and repeatable performance |
| Operation from DC to 40 GHz | Supports a wide range of RF test and signal routing applications, including 2G, 3G, 4G and 5G, with a single device |
| Break-before-make configuration | Prevents a momentary connection of the old and new signal paths, reducing the inconsistent transient effects that could otherwise be observed during switching |
| USB & Ethernet control | USB HID and Ethernet (HTTP / Telnet) interfaces provide easy compatibility with a wide range of software setups and programming environments |
| Full software support | User friendly Windows GUI (graphical user interface) allows manual control straight out of the box, while the comprehensive API (application programming interface) with examples and instructions allows easy automation in most programming environments |



CASE STYLE: PF3290

DOWNLOAD

SOFTWARE PACKAGE

RoHS Compliant

See our website for RoHS Compliance methodologies and qualifications





USB & ETHERNET CONTROLLED

Millimeter Switch Matrix **RC-2SP6T-40R**

Mini-Circuits

50Ω DC to 40 GHz 2.92mm-Female

ELECTRICAL SPECIFICATIONS AT 25°C

| Parameter | Conditions (GHZ) | Min. | Typ. | Max. | Units |
|---------------------------------|-----------------------------------|------|------|------|----------------|
| Frequency Range | | DC | | 40 | GHz |
| Insertion Loss | DC - 12 | — | 0.2 | 0.5 | dB |
| | 12 - 26 | — | 0.4 | 0.7 | |
| | 26 - 40 | — | 0.7 | 1.1 | |
| Isolation | DC - 12 | 60 | 90 | — | dB |
| | 12 - 26 | 55 | 80 | — | |
| | 26 - 40 | 50 | 70 | — | |
| VSWR ¹ | DC - 12 | — | 1.15 | — | :1 |
| | 12 - 26 | — | 1.30 | — | |
| | 26 - 40 | — | 1.45 | — | |
| Switching Time | — | — | 25 | — | ms |
| RF Input Power (Cold Switching) | DC - 12 | — | — | 20 | W |
| | 12 - 26 | — | — | 10 | |
| | 26 - 40 | — | — | 5 | |
| Switch Lifetime (per Switch) | 100 mW hot switching ² | 2 | — | — | million cycles |
| | 1W hot switching | — | 1 | — | |
| Rated Voltage | 24V _{DC} input | 23 | 24 | 25 | V |
| | USB port | — | 5 | — | |
| Rated Current (24V DC Input) | Both switches in state 1-6 | — | 440 | — | mA |
| | Both switches in state 0 | — | 90 | 120 | |
| Rated Current (USB) | | — | 10 | 20 | mA |

1. VSWR spec applies on any through path; all disconnected ports are reflective
2. Hot switching powers above this level will degrade the switch lifetime

ABSOLUTE MAXIMUM RATINGS

| Parameter | Ratings |
|-----------------------|---------------|
| Operating Temperature | 0°C to 40°C |
| Storage Temperature | -15°C to 85°C |
| Supply Voltage | 26V |





USB & ETHERNET CONTROLLED

Millimeter Switch Matrix RC-2SP6T-40R

Mini-Circuits

50Ω DC to 40 GHz 2.92mm-Female

SWITCHING CONFIGURATION:

- Normally open (all port disconnected)
- Reflective (unterminated)

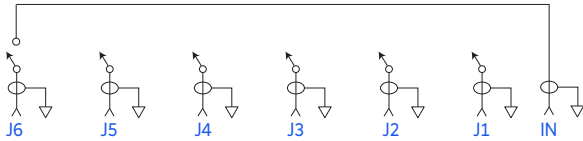

CONNECTIONS

| Port Name | Connector Type |
|--------------------------------------|---------------------------------|
| RF Switch A (Com, 1, 2, 3, 4, 5 & 6) | 2.92 mm female |
| RF Switch B (Com, 1, 2, 3, 4, 5 & 6) | 2.92 mm female |
| USB | USB type-B |
| Ethernet / LAN | RJ45 |
| 24V _{DC} Input | 2.1mm center positive DC socket |

OUTLINE DRAWING (PF3290)

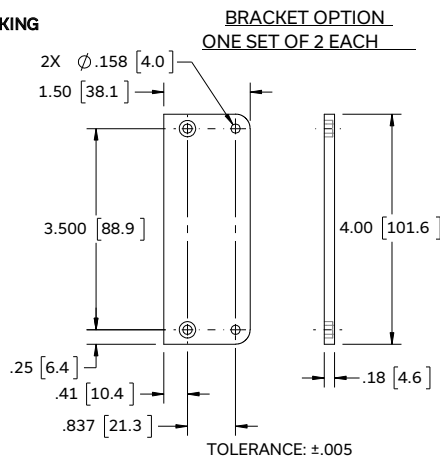
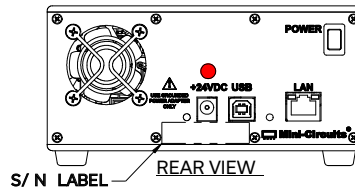
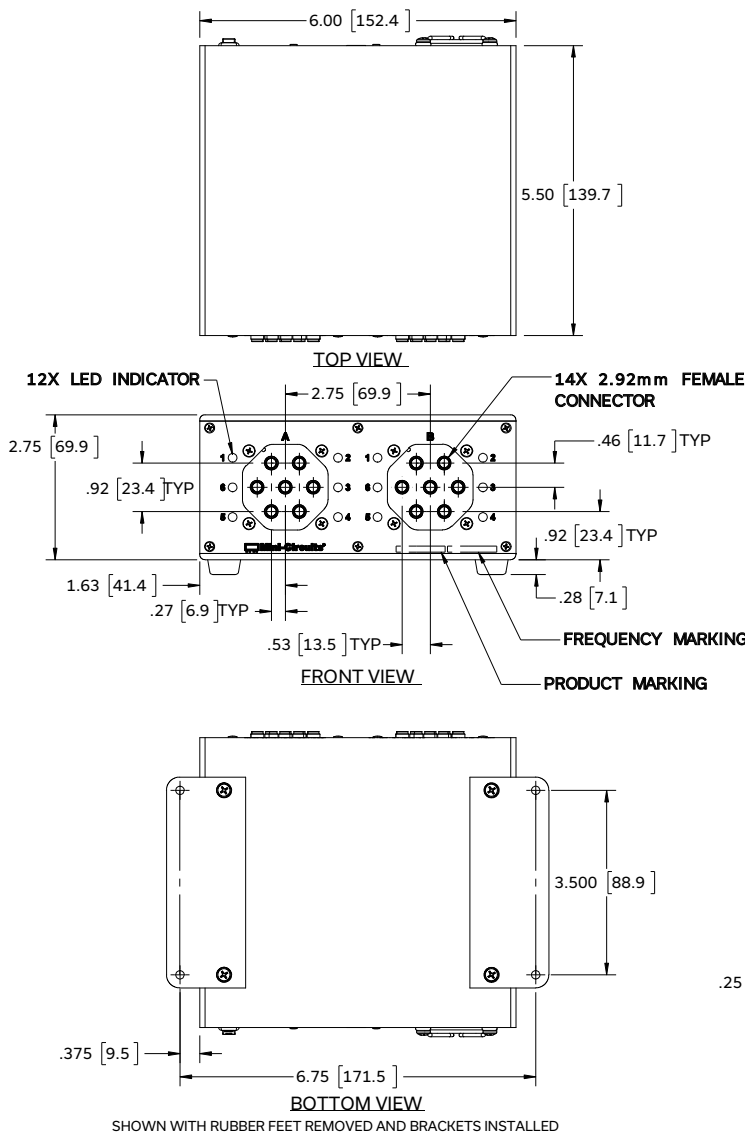

INSTRUCTIONS FOR MOUNTING BRACKETS:
TOOL REQUIRED: PHILLIPS HEAD SCREWDRIVER
STEP 1: REMOVE RUBBER FEET FROM THE BOTTOM OF THE UNIT, DO NOT DISCARD THE FASTENERS.
STEP 2: MOUNT THE BRACKETS WITH THE FASTENERS REMOVED IN STEP 1, USING THE COUNTER BORE HOLES IN THE BRACKET.

Weight: 1260 grams
Dimensions are in inches [mm]. Tolerances: 2 Pl. ±.03 inch; 3Pl. ±.015 inch

Mini-Circuits



USB & ETHERNET CONTROLLED

Millimeter Switch Matrix RC-2SP6T-40R

50Ω DC to 40 GHz 2.92mm-Female

TYPICAL PERFORMANCE DATA (PER SWITCH)

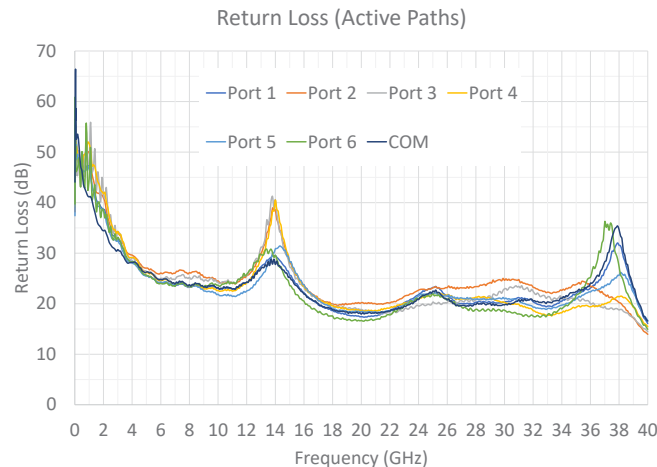
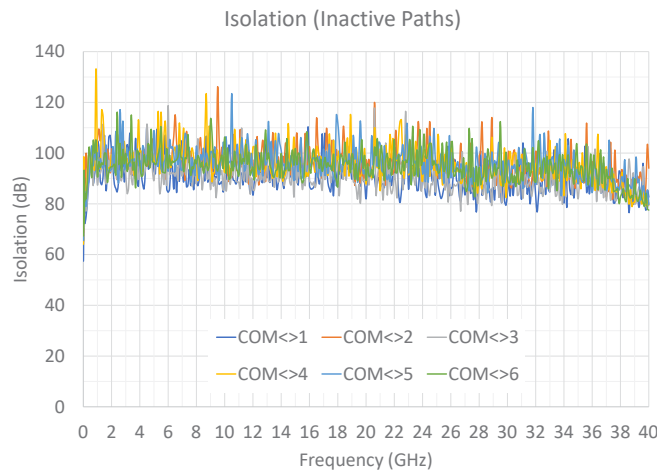
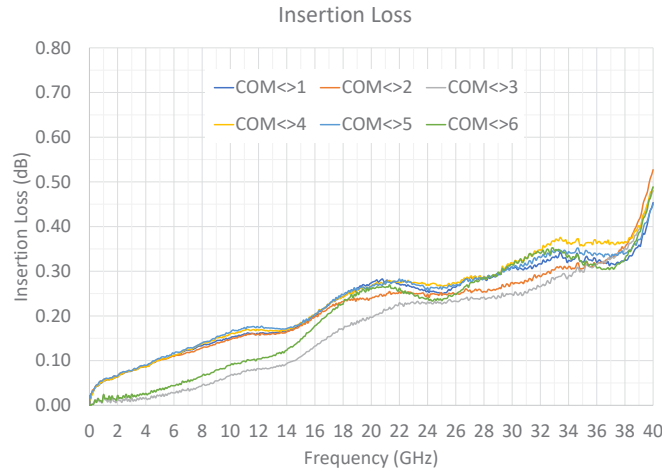



USB & ETHERNET CONTROLLED

Millimeter Switch Matrix **RC-2SP6T-40R**

50Ω DC to 40 GHz 2.92mm-Female

SOFTWARE SPECIFICATIONS

SOFTWARE & DOCUMENTATION DOWNLOAD:

- Mini-Circuits' full software and support package including user guide, Windows GUI, DLL files, programming manual and examples can be downloaded free of charge from: <https://www.minicircuits.com/softwaredownload/rfswitchcontroller.html>
- Please contact testsolutions@minicircuits.com for support

MINIMUM SYSTEM REQUIREMENTS:

| Parameter | Requirements | |
|---------------------|-------------------------------------|--|
| Interface | USB HID & Ethernet (HTTP & Telnet) | |
| System Requirements | GUI | Windows 98 or later |
| | USB API DLL | Windows 98 or later and programming environment with ActiveX or .NET support |
| | USB Direct Programming | Linux, Windows 98 or later |
| | Ethernet | Windows, Linux or Mac computer with a network port and Ethernet TCP/IP support |
| Hardware | Pentium II or later with 256 MB RAM | |

APPLICATION PROGRAMMING INTERFACE (API)

ETHERNET SUPPORT:

- Simple ASCII / SCPI command set for attenuator control
- Communication via HTTP or Telnet
- Supported by most common programming environments

USB SUPPORT (WINDOWS):

- ActiveX COM DLL file for creation of 32-bit programs
- .NET library DLL file for creation of 32 / 64-bit programs
- Supported by most common programming environments (refer to application note AN-49-001 for summary of supported environments)

USB SUPPORT (LINUX):

- Direct USB programming using a series of USB interrupt codes

Full programming instructions and examples available for a wide range of programming environments / languages.



USB & ETHERNET CONTROLLED

Millimeter Switch Matrix RC-2SP6T-40R

50Ω DC to 40 GHz 2.92mm-Female

GRAPHICAL USER INTERFACE (GUI) FOR WINDOWS - KEY FEATURES

- Connect via USB or Ethernet
- Run GUI in "demo mode" to evaluate software without a hardware connection

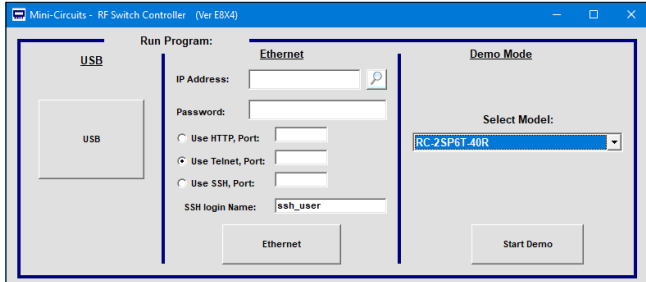

- View and set switch states at the click of a button
- Configure and run timed switching sequences
- Set start-up switch state
- Configure Ethernet IP settings

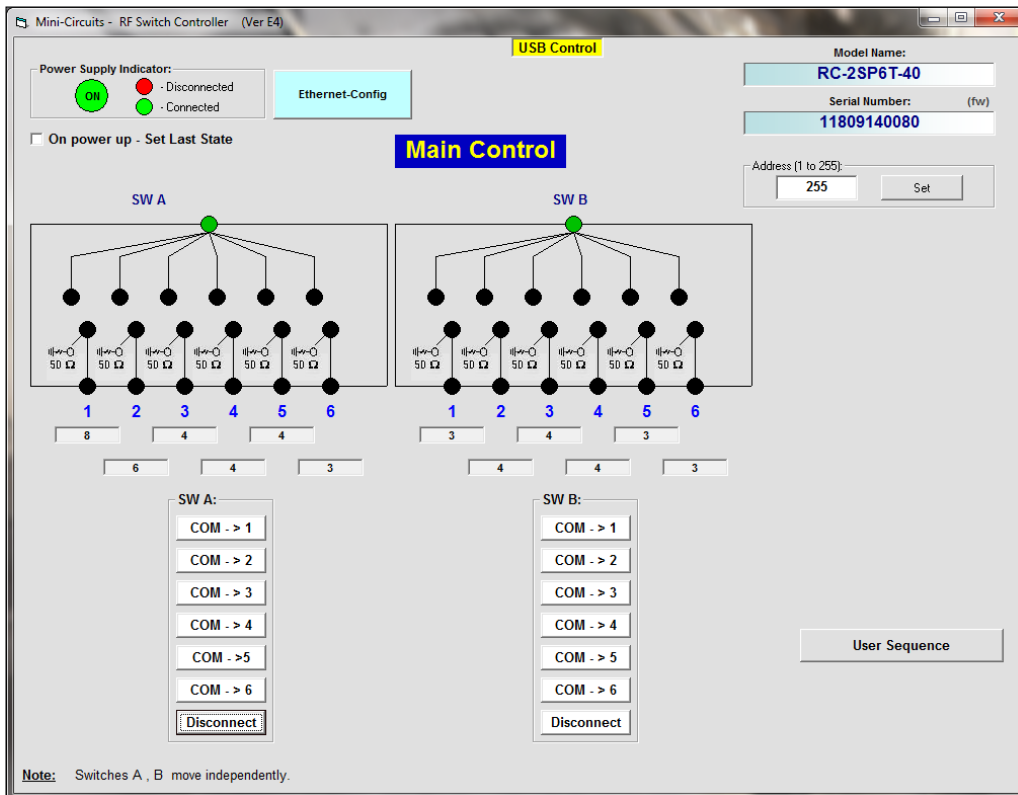



USB & ETHERNET CONTROLLED

Millimeter Switch Matrix **RC-2SP6T-40R**

Mini-Circuits



50Ω DC to 40 GHz 2.92mm-Female





ORDERING INFORMATION

Refer to Mini-Circuits' website for pricing and availability information:

<https://www.minicircuits.com/WebStore/dashboard.html?model=RC-2SP6T-40R>

| Model | Description |
|--------------|--|
| RC-2SP6T-40R | USB & Ethernet controlled SP6T switch matrix |

| Included Accessories | Part No. | Description |
|---|---------------|--|
|  | AC/DC-24-3W1 | AC/DC 24V _{DC} Grounded Power Adaptor. Operating temperature: 0°C to +40°C, I _{Max} =2.5A |
| See Below | CBL-3W1-XX | AC Power Cord (Select one power cord from below with each Switch Matrix box) |
|  | USB-CBL-AB-3+ | 2.7 ft (0.8 m) USB Cable: USB type A(Male) to USB type B(Male) |

| AC Power Cords ³ | Part No. | Description |
|---|------------|------------------------------------|
|  | CBL-3W1-US | Power Cord for United States |
|  | CBL-3W1-EU | Power Cord for Europe |
|  | CBL-3W1-UK | Power Cord for United Kingdom |
|  | CBL-3W1-AU | Power Cord for Australia and China |
|  | CBL-3W1-IL | Power Cord for Israel |

3. If you need a Power cord for a country not listed please contact testsolutions@minicircuits.com

OPTIONAL ACCESSORIES

| | |
|----------------|--|
| USB-CBL-AB-3+ | 2.7 ft (0.8 m) USB Cable: USB type A(Male) to USB type B(Male) |
| USB-CBL-AB-7+ | 6.8 ft (2.1 m) USB Cable: USB type A(Male) to USB type B(Male) |
| USB-CBL-AB-11+ | 11 ft (3.4 m) USB Cable: USB type A(Male) to USB type B(Male) |
| CBL-RJ45-MM-5+ | 5 ft (1.5 m) Ethernet cable: RJ45(Male) to RJ45(Male) Cat 5E cable |
| BKT-272-08+ | Bracket (One set of 2 each) |

