



USB & ETHERNET CONTROLLED

# Mechanical Switch

## RC-8SPDT-A26

50Ω DC to 26.5 GHz 8 x SPDT SMA Female

### THE BIG DEAL

- 8 x mechanical SPDT absorptive switches
- Excellent performance to 26.5 GHz
- Ethernet & USB control
- Fail-safe / redundancy switching
- LED switch state indicators



Generic photo used for illustration purposes only

### APPLICATIONS

- Automated test & measurement systems
- 5G FR1, WiFi 6E, UWB, Bluetooth
- Harmonic testing
- Switch matrices

### FUNCTIONAL BLOCK DIAGRAM (EACH SWITCH)

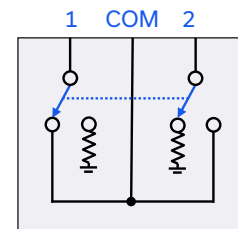

### PRODUCT OVERVIEW

Mini-Circuits' RC-8SPDT-A26 houses 8 independently controlled electro-mechanical SPDT switches. Each switch operates over a wide bandwidth, from DC to 26.5 GHz with high isolation and low insertion loss. The absorptive switches are failsafe, with a break before make configuration, and lifetime of 2 million switching cycles typically when used within the noted specifications.

The switch box is constructed in a compact, rugged metal case with SMA (f) connectors and LED position indicators on the front panel to enable easy access on a test bench. The switches are controlled via USB or Ethernet, allowing control directly from a PC, or remotely over a network. Full software support is provided, including our user-friendly GUI application for Windows and a full API with programming instructions for Windows and Linux environments.

### KEY FEATURES

Feature	Advantages
Mechanical switches	Mechanical absorptive switches provide low loss, high isolation, high reliability, repeatable performance and internal termination of input signals on the disconnected paths
Fail-safe design	The switches revert to a known default state when the DC supply is removed, allowing their use in systems that must continue to operate safely in the event of power failure
Break-before-make configuration	Prevents a momentary connection of the old and new signal paths, reducing the inconsistent transient effects that could otherwise be observed during switching
USB & Ethernet control	USB HID and Ethernet (HTTP / Telnet) interfaces provide easy compatibility with a wide range of software setups and programming environments

REV. B  
ECO-019323  
RC-8SPDT-A26  
MCL NY  
240109





USB & ETHERNET CONTROLLED

# Mechanical Switch

## RC-8SPDT-A26

50Ω DC to 26.5 GHz 8 x SPDT SMA Female

### ELECTRICAL SPECIFICATIONS AT +25°C (EACH SWITCH)

Parameter	Conditions	Min.	Typ.	Max.	Units
Frequency Range		DC		26.5	GHz
Insertion Loss	DC-8 GHz		0.15	0.30	dB
	8-18 GHz		0.30	0.50	
	18-26.5 GHz		0.60	0.80	
Isolation (Inactive Paths) <sup>1</sup>	DC-8 GHz	75	90		dB
	8-18 GHz	60	66		
	18-26.5 GHz	55	65		
Return Loss <sup>2</sup>	DC-8 GHz		20		dB
	8-18 GHz		20		
	18-26.5 GHz		16		
Switching Time			25		ms
RF Input Power (Cold Switching)	DC-26.5 GHz			30	W
	Into internal termination			1	
Switch Lifetime	100 mW hot switching <sup>3</sup>		2		million cycles
	1W hot switching		1		

1. Isolation measured between Com and any disconnected port. Example: Isolation for Com to 1 is the leakage measured at port 1 from a signal input at Com when the active switch path is set to Com to 2.

2. Return loss into all ports in all states

3. Hot switching power above this level will degrade the switch lifetime



USB & ETHERNET CONTROLLED

# Mechanical Switch

## RC-8SPDT-A26

50Ω DC to 26.5 GHz 8 x SPDT SMA Female

### CONTROL INTERFACES

Ethernet Control	Supported Protocols	TCP / IP, HTTP, Telnet, DHCP, UDP (limited)
	Max Data Rate	10 Mbps (10 Base-T Half Duplex)
USB Control	Supported Protocols	HID - Full Speed
	Min Communication Time <sup>1</sup>	3 ms typ

1. Based on the polling interval of the USB HID protocol (1 ms with 64 bytes per packet) and no other significant CPU or USB activity

### SOFTWARE & DOCUMENTATION

Mini-Circuits' full software and support package including user guide, Windows GUI, API, programming manual and examples can be downloaded free of charge (refer to the last page for the download path).

A comprehensive set of software control options is provided:

- GUI for Windows – Simple software interface for control via Ethernet and USB
- Programming / automation via Ethernet
  - Complete set of control commands which can be sent via any supported protocol – simple to implement in the majority of modern programming environments
- Programming / automation via USB
  - DLL files provide a full API for Windows with a set of intuitive functions which can be implemented in any programming environment supporting .Net Framework or ActiveX
  - Direct USB programming is possible in any other environment (not supporting .Net or ActiveX)

Please contact [testsolutions@minicircuits.com](mailto:testsolutions@minicircuits.com) for support

### MINIMUM SYSTEM REQUIREMENTS

	Requirements
Hardware	Intel i3 (or equivalent) or later
GUI (USB or Ethernet Control)	Windows 7 or later
USB API DLL	Windows 7 or later with support for Microsoft .Net Framework or ActiveX
USB Direct Programming	Windows 7 or later; Linux
Ethernet	Windows, Linux or macOS with Ethernet TCP / IP support

### PROGRAMMING COMMANDS

The key ASCII / SCPI commands for control of the system for control via the Ethernet or USB API are summarized below (refer to the programming manual for full details):

Command / Query	Description
:MN?	Read model name
:SN?	Read serial number
:FIRMWARE?	Read firmware version
SET[sw_label]=[port]	Set a single switch state: <ul style="list-style-type: none"> <li>• [sw_label] = A to H</li> <li>• [port] = 0 (Com to 1) or 1 (Com to 2)</li> <li>• Example: SETA=1 (set SPDT A with Com to 2)</li> </ul>
SWPORT?	Get the state of all switches: <ul style="list-style-type: none"> <li>• Returns a byte value, with the 2 least significant bits each representing the state of an individual SPDT (switch A is the least significant bit). The value for each switch will be:               <ul style="list-style-type: none"> <li>• 0 = COM to 1</li> <li>• 1 = COM to 2</li> </ul> </li> <li>• Example: A returned value of 2 is represented as 00000010 indicating SW B = 1 (Com to 2) &amp; SW A = 0 (Com to 1)</li> </ul>





USB & ETHERNET CONTROLLED

# Mechanical Switch

## RC-8SPDT-A26

50Ω DC to 26.5 GHz 8 x SPDT SMA Female

### GRAPHICAL USER INTERFACE (GUI) FOR WINDOWS

- Connect via USB or Ethernet
- Run GUI in "demo mode" to evaluate software without a hardware connection

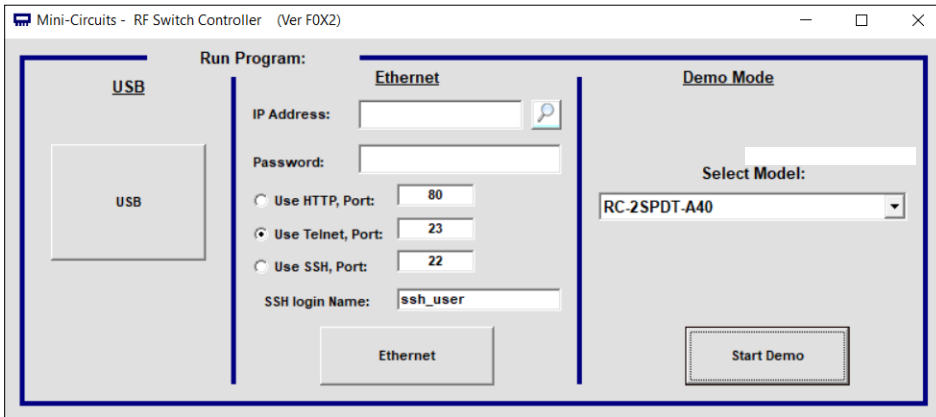

- View and set all switch states at the click of a button
- Configure automated / timed switching sequences
- Configure Ethernet settings
- Update firmware

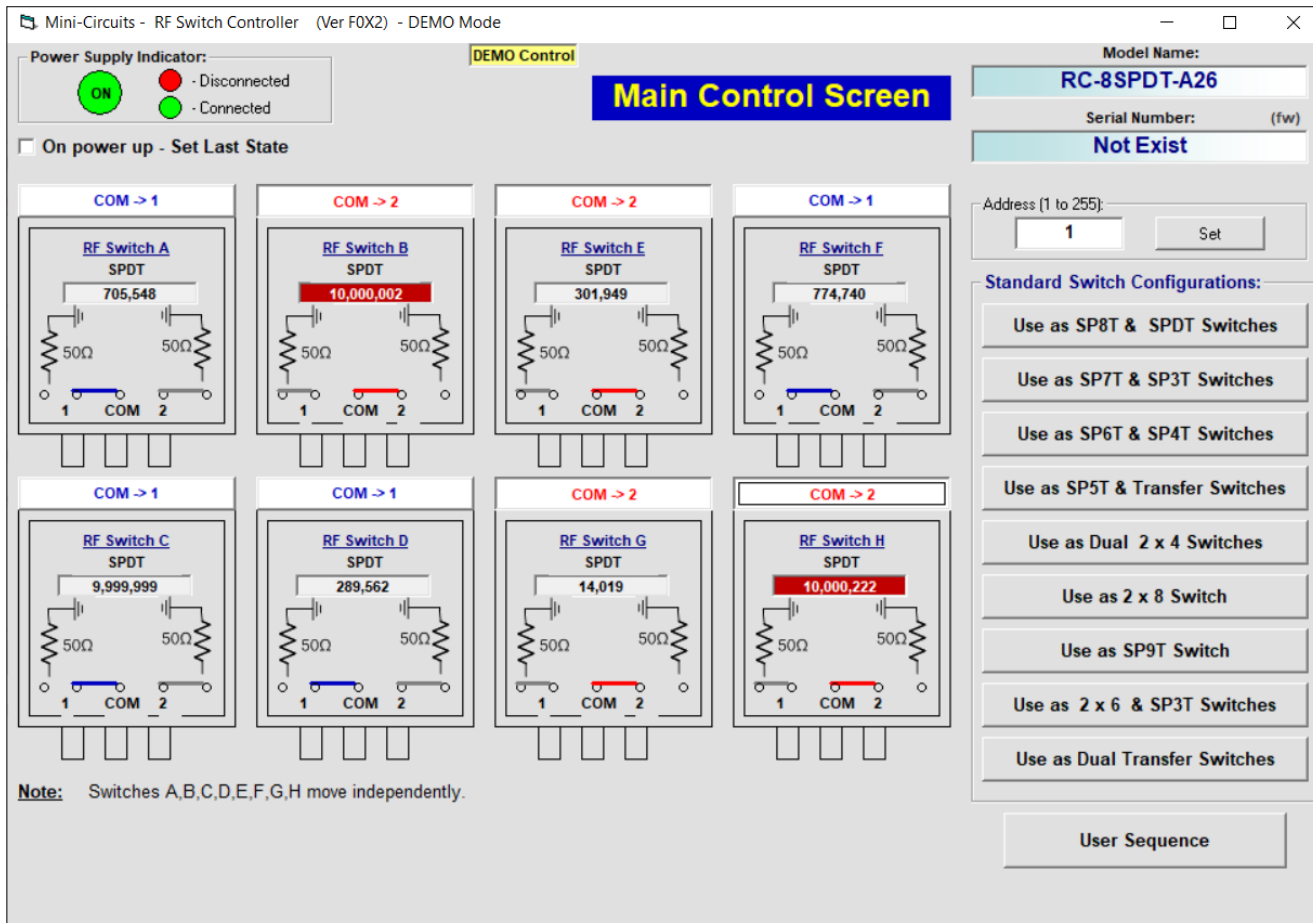



USB & ETHERNET CONTROLLED

# Mechanical Switch

## RC-8SPDT-A26

Mini-Circuits

50Ω DC to 26.5 GHz 8 x SPDT SMA Female

### TYPICAL PERFORMANCE GRAPHS

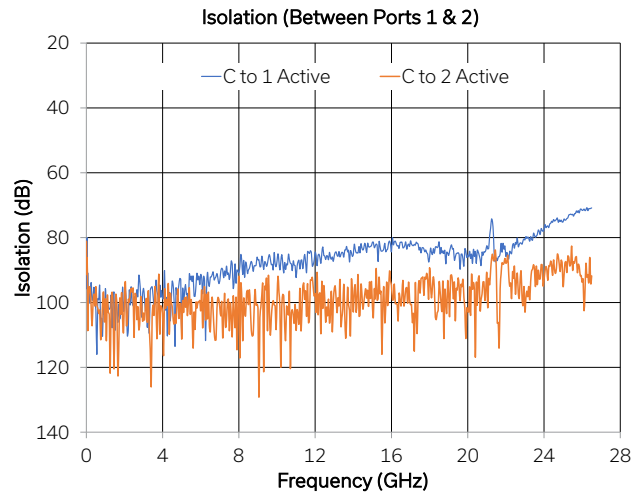
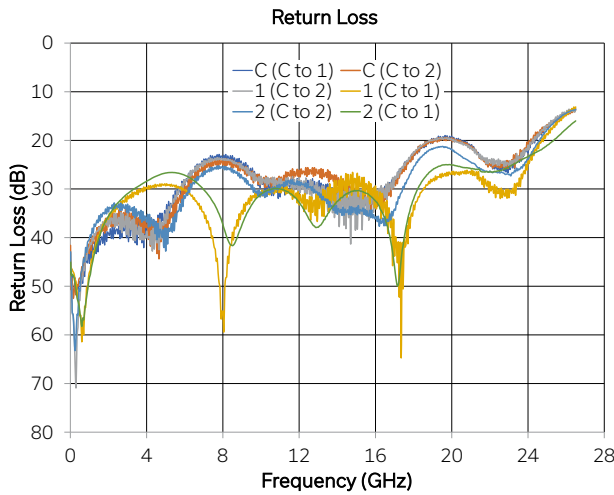
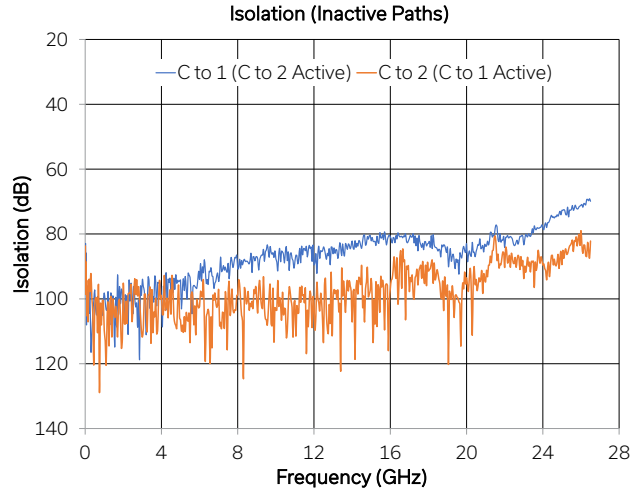
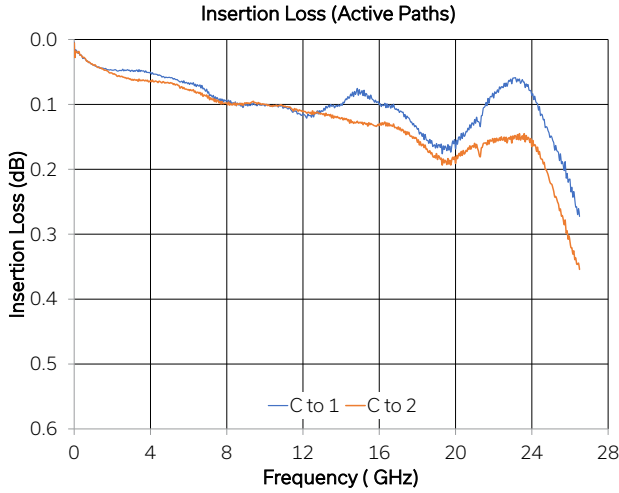



USB & ETHERNET CONTROLLED

# Mechanical Switch

## RC-8SPDT-A26

50Ω DC to 26.5 GHz 8 x SPDT SMA Female

### ABSOLUTE MAXIMUM RATINGS

Parameter	Conditions	Limits	Units
Temperature	Operating	0 to +40	°C
	Storage	-15 to +85	
DC Supply Voltage		26	V
Input Power (No Damage)	Cold switching:	30	W
	Hot switching	1	
	Into internal termination	1	

Permanent damage may occur if any of these limits are exceeded. Operating in the range between operating power limits and absolute maximum ratings for extended periods of time may result in reduced life and reliability.

### POWER SUPPLY

Parameter	Conditions	Typ	Max	Units
DC Voltage		24	26	V
Current Consumption	All switches C to 1	120		mA
	All switches C to 2	1800		

Using included AC/DC-24-3W1 power supply adapter (110 / 240 V AC input)

### CONNECTIONS

Port	Connector
SW A-H (COM, 1 & 2 per switch)	SMA female
USB	USB type B
Ethernet / LAN	RJ45
24V DC Input	2.1 mm center positive DC socket

COM = Common port  
1 & 2 = Input / output ports

### FUNCTIONAL BLOCK DIAGRAM

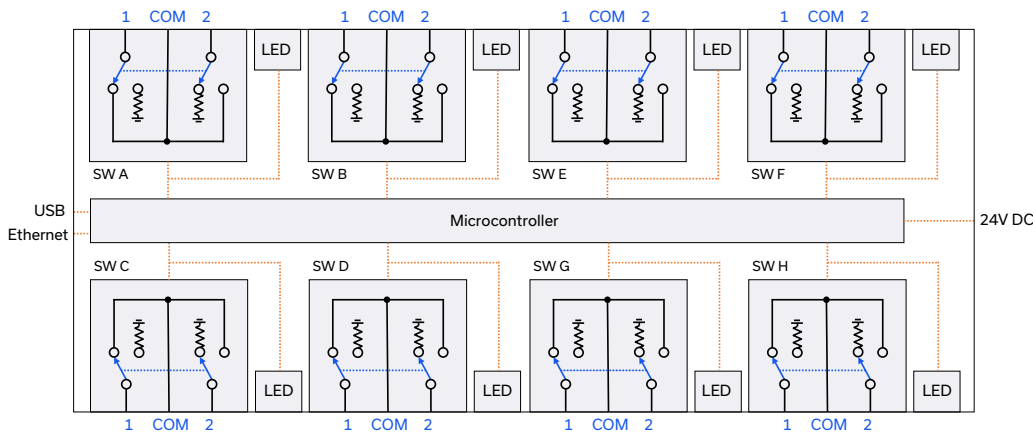

### SWITCH STATE TABLE (EACH SWITCH)

Switch Command	Switch [x] State	LED [x] State
SET[x]=1	COM to 1	Green
SET[x]=2	COM to 2	Red

[x] = Switch label, A to H



USB & ETHERNET CONTROLLED

# Mechanical Switch

## RC-8SPDT-A26

Mini-Circuits

50Ω DC to 26.5 GHz 8 x SPDT SMA Female

### CASE STYLE DRAWING

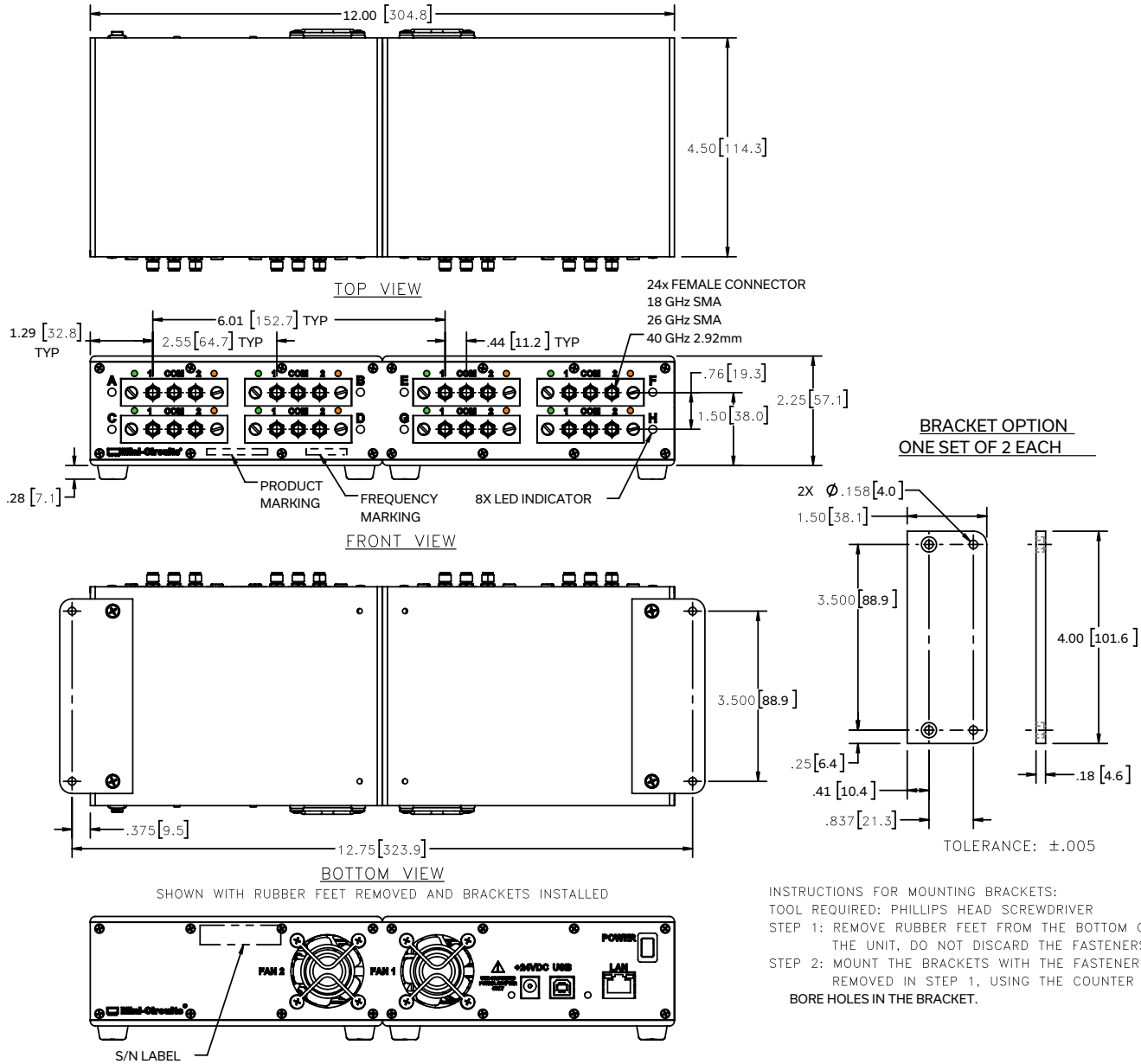

Weight: 2240 grams.

Dimensions are in inches [mm]. Tolerances: 2 Pl. ±.03 inch; 3 Pl. ±.015 inch.

### PRODUCT MARKING\*

Product Marking: RC-8SPDT-A26

Product Frequency: DC - 26.5 GHz

Serial Number

\*Marking may contain other features or characters for internal lot control





USB & ETHERNET CONTROLLED

# Mechanical Switch



## RC-8SPDT-A26





50Ω DC to 26.5 GHz 8 x SPDT SMA Female

DETAILED MODEL INFORMATION IS AVAILABLE ON OUR WEBSITE [CLICK HERE](#)

Case Style	LM1852
Software, User Guide & Programming Manual	<a href="http://www.minicircuits.com/softwaredownload/rfswitchcontroller.html">www.minicircuits.com/softwaredownload/rfswitchcontroller.html</a>
Environmental Rating	ENV104
Regulatory Compliance	<p>Refer to our website for compliance methodologies and qualifications</p>  <p><a href="http://www.minicircuits.com/quality/environmental_introduction.html">www.minicircuits.com/quality/environmental_introduction.html</a></p>

Contact Us: [testsolutions@minicircuits.com](mailto:testsolutions@minicircuits.com)

Included Accessories	Part Number	Description
	AC/DC-24-3W1	AC/DC 24V DC grounded power adaptor. Operating temperature 0 to +40 °C, max current 2.5A, IEC C6 AC inlet.
	CBL-3W1-xx	AC power cord (IEC C5 connector to local plug) Select one option from the list below. Please contact <a href="mailto:testsolutions@minicircuits.com">testsolutions@minicircuits.com</a> if your regions is not listed.
	USB-CBL-AB-3+	USB cable (2.7 ft) type A to type B
	CBL-RJ45-MM-5+	Ethernet cable (5 ft)

AC Power Cord Options	Part Number	Description
	CBL-3W1-US	USA NEMA 5-15 plug (type B) to IEC C5 connector
	CBL-3W1-EU	Europe CEE 7/7 plug (type E/F) to IEC C5 connector
	CBL-3W1-UK	UK BS-1363 plug (type G) to IEC C5 connector
	CBL-3W1-AU	Australia & China AS/NZS 3112 plug (type I) to IEC C5 connector
	CBL-3W1-IL	Israel SI-32 plug (type H) to IEC C5 connector

- NOTES**
- A. Performance and quality attributes and conditions not expressly stated in this specification document are intended to be excluded and do not form a part of this specification document.
  - B. Electrical specifications and performance data contained in this specification document are based on Mini-Circuit's applicable established test performance criteria and measurement instructions.
  - C. The parts covered by this specification document are subject to Mini-Circuits standard limited warranty and terms and conditions (collectively, "Standard Terms"); Purchasers of this part are entitled to the rights and benefits contained therein. For a full statement of the standard. Terms and the exclusive rights and remedies thereunder, please visit Mini-Circuits' website at [www.minicircuits.com/terms/viewterm.html](http://www.minicircuits.com/terms/viewterm.html)

