

Programmable Attenuator

RC4DAT-6G-60

50Ω 0 – 63 dB, 0.25 dB step 1 to 6000 MHz

The Big Deal

- Four independently programmable channels
- Wide attenuation range, 63 dB
- Fine attenuation resolution, 0.25 dB
- Short attenuation transition time (650 ns)
- **USB and Ethernet** control



Software Package

Case Style: QE2249

Applications

- MIMO test sets
- Automated Test Equipment (ATE)
- WiMAX, 3G, 4G, LTE, DVB Fading Simulators
- Handover system Evaluation
- Power level cycling

Included Accessories

Model No.	Description	Qty.
MUSB-CBL-3+	3.3 ft. USB cable	1

RoHS Compliant

See our web site for RoHS Compliance methodologies and qualifications

Product Overview

Mini-Circuits' RC4DAT-6G-60 is a 4-channel programmable attenuator suitable for a wide range of signal level control applications from 1 MHz to 6 GHz. Each independently controlled channel provides 0 to 63 dB attenuation in 0.25 dB steps with more than 100 dB isolation between channels. Its unique design maintains linear attenuation change per dB, even at the highest attenuation settings.

All 4 bi-directional RF channels are housed in a single, compact and rugged package with SMA female connectors on all RF ports, a standard Ethernet port (RJ45) and a USB type Mini-B power and control port.

The attenuator can be controlled via USB or Ethernet (supporting HTTP, Telnet and SSH network protocols). Full software support is provided and can be downloaded from our website any time at <http://www.minicircuits.com/softwaredownload/patt.html>. The package includes our user-friendly GUI application for Windows® and a full API with programming instructions for Windows® and Linux® environments (both 32-bit and 64-bit systems).

Key Features

Feature	Advantages
USB & Ethernet control	USB HID and Ethernet (HTTP / Telnet / SSH) interfaces provide easy compatibility with a wide range of software setups and programming environments. The device draws all power requirements through the USB port.
Programmable attenuation sweep and Hop sequences	The RC4DAT-6G-60 can be programmed with a timed sequence of attenuation settings, to run without any additional external control
63 dB attenuation range.	The RC4DAT-6G-60 provides high-accuracy attenuation up to 63 dB, allowing the user precise level control over a broad attenuation and frequency range.
High linearity	Typical input IP3 of +53 dBm up to 6000 MHz

Trademarks: Windows is a registered trademark of Microsoft Corporation in the United States and other countries. Linux is a registered trademark of Linus Torvalds. Mac is a registered trademark of Apple Corporation. SSH is a registered trademark of SSH Communications Security Corp. Pentium is a registered trademark of Intel Corporation. Neither Mini-Circuits nor the Mini-Circuits RC4DAT-series attenuators are affiliated with or endorsed by the owners of the above referenced trademarks.

Mini-Circuits and the Mini-Circuits logo are registered trademarks of Scientific Components Corporation.



Electrical Specifications ^{1,2} at 0°C to 50°C

Parameter	Frequency range	Conditions	Min.	Typ.	Max.	Units
Attenuation range	1 - 6000 MHz	0.25 dB step	0	-	63	dB
Attenuation accuracy ³	1 - 2000 MHz	@ 0.25 - 20 dB	-	±0.25	±(0.45+4.5% of nominal value)	dB
		@ 20.25 - 63 dB	-	±0.85	±(0.75+2% of nominal value)	
	2000 - 4000 MHz	@ 0.25 - 20 dB	-	±0.35	±(0.45+4.5% of nominal value)	
		@ 20.25 - 63 dB	-	±0.70	±(0.85+1.5% of nominal value)	
	4000 - 6000 MHz	@ 0.25 - 20 dB	-	±0.25	±(0.5+4.5% of nominal value)	
		@ 20.25 - 63 dB	-	±0.55	±(0.7+2.5% of nominal value)	
Insertion Loss	1 - 2000 MHz	@ 0 dB	-	3.0	5.0	dB
	2000 - 4000 MHz		-	4.7	6.5	
	4000 - 6000 MHz		-	6.2	7.5	
Isolation In - Out (within a channel)	1 - 6000 MHz	Note 4	-	67	-	dB
Isolation (between channels)	1 - 6000 MHz	@ 0 - 63 dB	95	-	-	
Input operating power ⁵ (RF In and RF Out out ports)	1 - 50 MHz	@ 0 - 63 dB	-	-	Note 6	dBm
	50 - 6000 MHz		-	-	+23	
IP3 Input ⁷	1 - 3000 MHz	@ 0 dB setting (P _{IN} =+5 dBm)	-	+53	-	dBm
	3000 - 6000 MHz		-	+51	-	
VSWR	1 - 4000 MHz	@ 0 - 63 dB	-	1.25	-	:1
	4000 - 6000 MHz		-	1.40	-	
Min Dwell Time per channel ⁸	1 - 6000 MHz	High speed mode	-	600	-	µsec
Channel Synchronization ⁹	1 - 6000 MHz	-	-	400	-	µsec
Attenuation Transition Time ¹⁰	-	via USB port	-	650	-	nsec
Supply Voltage	-	-	4.75	5	5.25	V
USB current draw	-	-	-	190	330	mA

¹ Attenuator RF ports are interchangeable, and support simultaneous, bidirectional signal transmission, however the specifications are guaranteed for the RF in and RF out as noted on the label. There may be minor changes in performance when injecting signals to the RF Out port.

² RF performance specified per channel, performance of all four channels is identical.

³ Max accuracy defined as ±[absolute error+% of attenuation setting] for example when setting the attenuator to 55 dB attenuation the maximum error at 5000 MHz will be: ±(0.7+0.025x55)= ±(0.7+1.375)= ± 2.075 dB

⁴ Isolation In-Out is defined as max attenuation plus insertion loss; this is the path loss through the attenuator when initially powered up. After a brief delay (~0.5 sec typically) the attenuator will revert to a user defined "power-up" state (either max attenuation or a pre-set value).

⁵ Total operating input power per channel from both RF In and RF Out out ports. Compression level not noted as it exceeds max safe operating power level.

⁶ Derate linearly from +23 dBm at 50 MHz to +9 dBm at 1 MHz.

⁷ Tested with 1 MHz span between signals.

⁸ Minimum Dwell Time is the time the RC4DAT will take to respond to a command to change attenuation states in a channel without communication delays. In PC control add communication delays (on the order of msec for USB) to get actual response time.

⁹ Channel Synchronization is the delay between the first and last attenuator transitions beginning, in response to a command to set all channels.

¹⁰ Attenuation Transition Time is specified as the time between starting to change the attenuation state and settling on the requested attenuation state.

Absolute Maximum Ratings

Operating Temperature	0°C to 50°C	
Storage Temperature	-20°C to 85°C	
V _{USB} Max.	6V	
DC voltage at RF port	16V	
Total RF power for RF In & RF Out	@ 1 to 50 MHz	Derate linearly from +12 dBm@ 1 MHz to +26 dBm@50 MHz
	@ 50 to 6000 MHz	+26 dBm

Permanent damage may occur if any of these limits are exceeded. Operating in the range between operating power limits and absolute maximum ratings for extended periods of time may result in reduced life and reliability.

Communication parameters

Interface	Parameter	Old units, up to S/N 12007129999	New units, from S/N 12007130001 and up
Ethernet control	supported protocols	TCP / IP, HTTP, Telnet, DHCP, UDP (limited)	TCP / IP, HTTP, Telnet, SSH, DHCP, UDP (limited)
	Max data rate	10 Mbps (10 Base-T Half Duplex)	100 Mbps (100 Base-T Full Duplex)
USB control	supported protocols	HID (Human Interface Device) - Full Speed	HID (Human Interface Device) - High Speed
	Min communication time	3 ms Typ ¹¹	400 μ s Typ ¹¹

¹¹ USB min communication time is based on the polling interval of the USB HID protocol (125 μ s polling interval, 1024 bytes per packet), medium CPU load and no other high speed USB devices using the USB bus.

RC4DAT response to communication interrupt

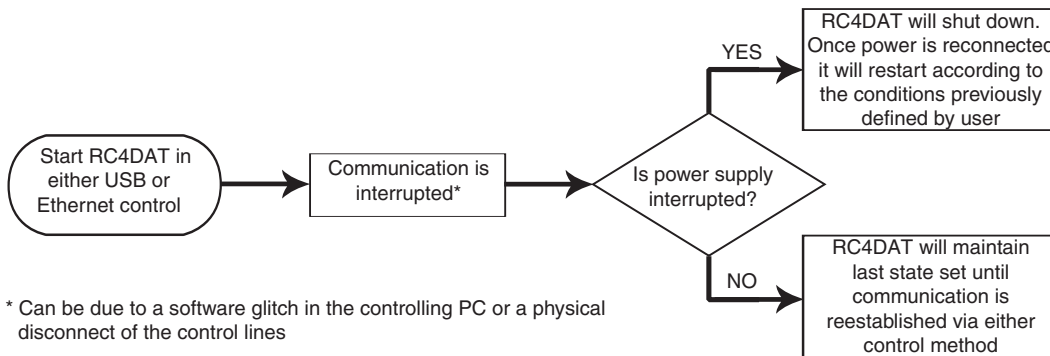

* Can be due to a software glitch in the controlling PC or a physical disconnect of the control lines

Block Diagram

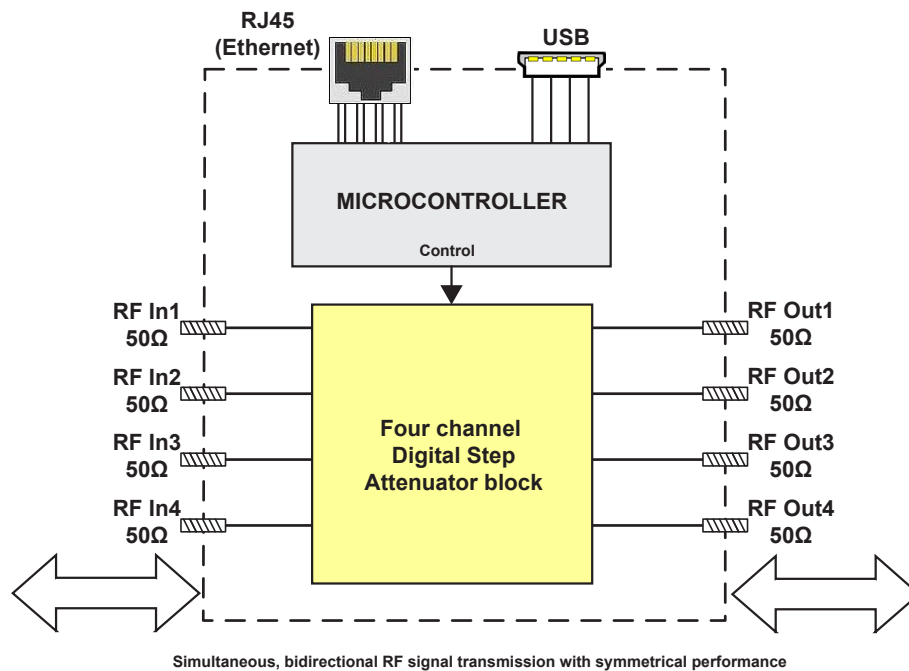

Connections

RF In 1,2,3,4	(SMA female)
RF Out 1,2,3,4	(SMA female)
USB	(USB type Mini-B female)
Network (Ethernet/LAN)	(RJ45 socket)

Outline Drawing (QE2249)

Connections

RF IN 1, 2, ,3, 4	(SMA female)
RF OUT 1, 2, ,3, 4	(SMA female)
USB	(USB type Mini-B female)
Network (Ethernet/LAN)	(RJ45 socket)

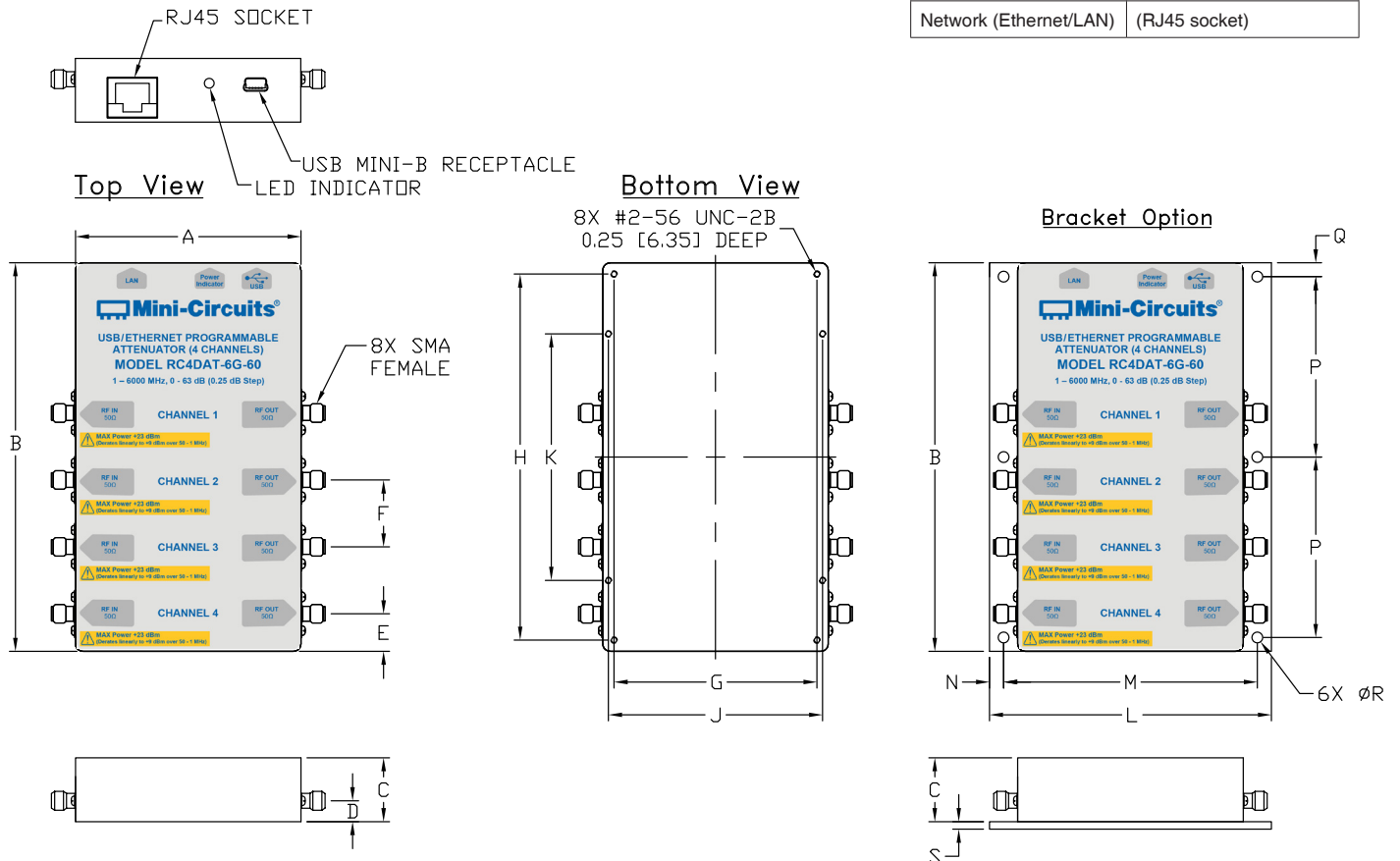

Instruction for mounting bracket:

1. Tool required: Phillips head screwdriver
2. Mount the bracket over threaded holes on the bottom side with the fasteners provided with the bracket.

Outline Dimensions (inch mm)

A	B	C	D	E	F	G	H	J	K	L	M	N	P	Q	R	S	T	WT. GRAMS
3.00	5.17	0.85	0.28	0.50	0.89	2.700	4.870	2.850	3.280	3.75	3.375	0.188	2.400	0.185	0.144	0.100	0.185	400
76.2	131.3	21.6	7.1	12.7	22.6	68.58	123.7	72.39	83.31	95.25	85.72	4.76	60.96	4.70	3.66	2.54	4.70	

Typical Performance Curves in a given channel

Attenuation Accuracy @ +25°C vs. Frequency over Attenuation settings

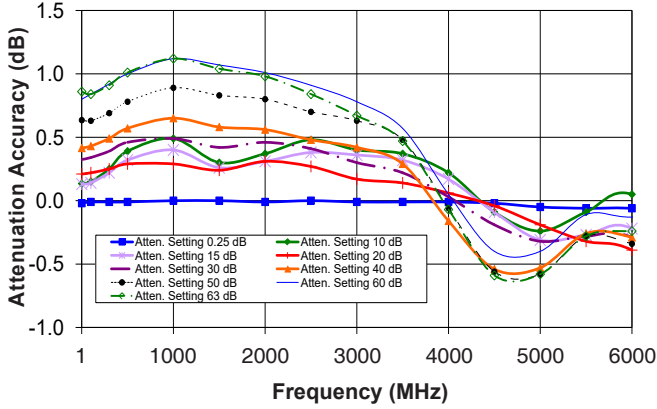

Attenuation relative to Insertion Loss @ +25°C vs. Frequency over Attenuation settings

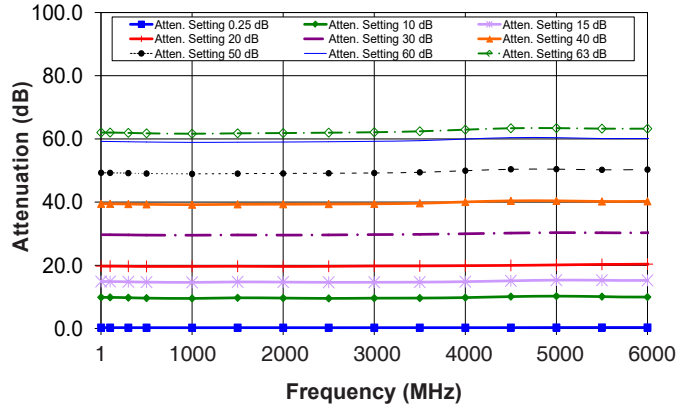

Attenuation Accuracy @ 0°C vs. Frequency over Attenuation settings

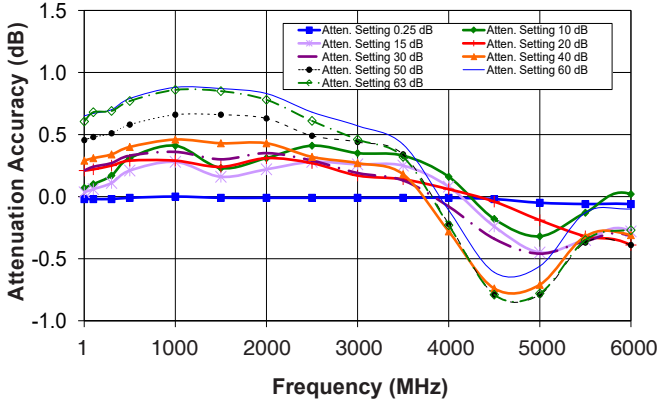

Attenuation relative to Insertion Loss @ 0°C vs. Frequency over Attenuation settings

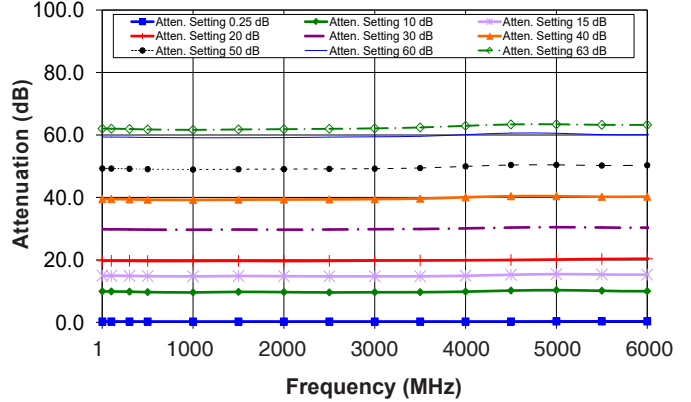

Attenuation Accuracy @ +50°C vs. Frequency over Attenuation settings

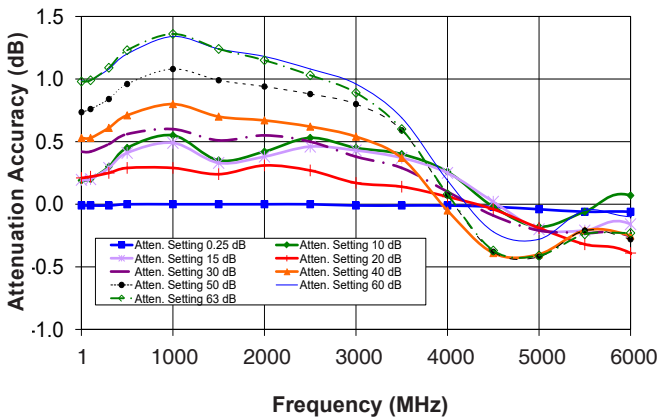

Attenuation relative to Insertion Loss @ +50°C vs. Frequency over Attenuation settings

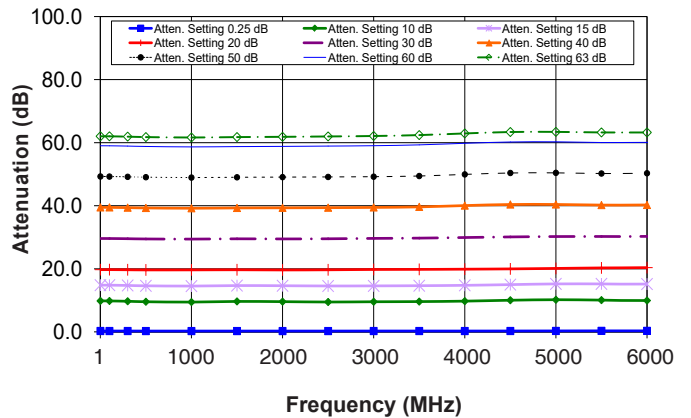

Typical Performance Curves in a given channel (Continued)

Insertion Loss @ Input Power 0dBm vs. Frequency over Temperatures

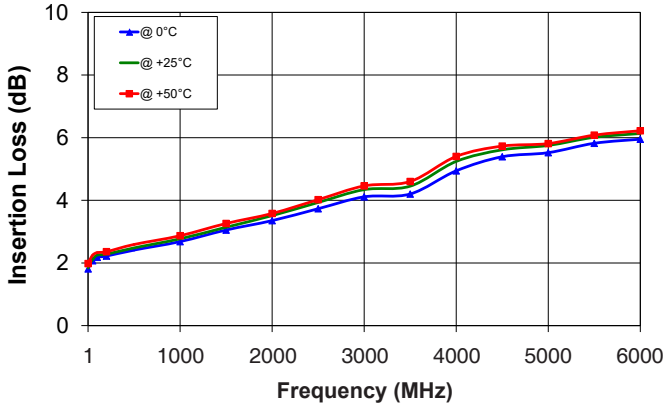

Insertion Loss @ Input Power +23 dBm vs. Frequency over Temperatures

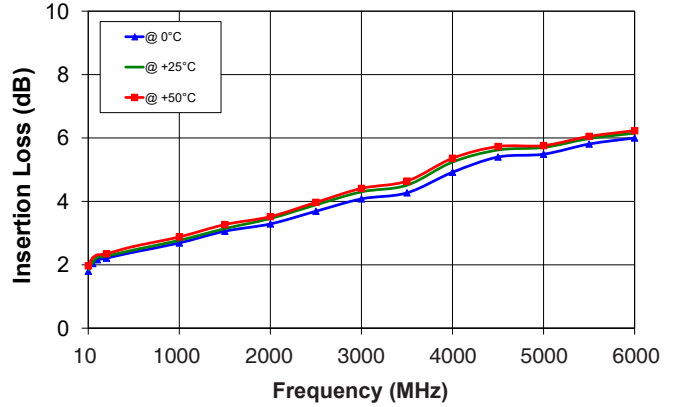

Output VSWR @ +25°C vs. Frequency over Attenuation settings

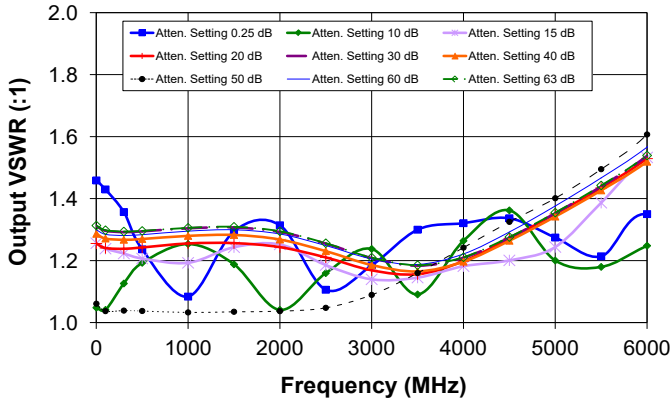

Input VSWR @ +25°C vs. Frequency over Attenuation settings

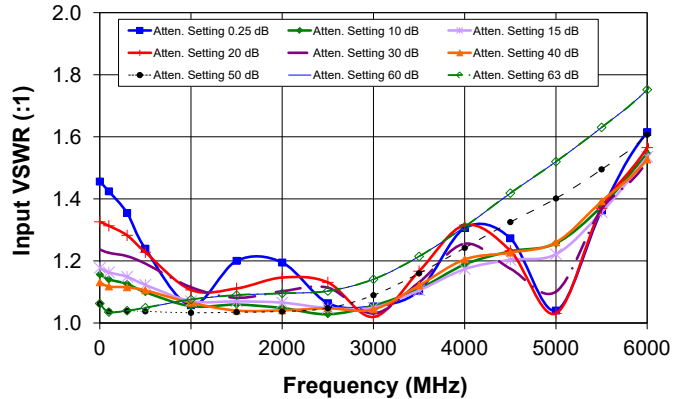

Input IP3 @ 0dB Attenuation vs. Frequency over Temperatures

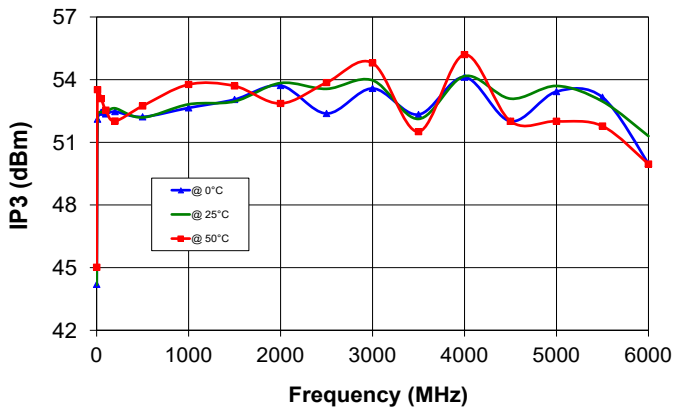

Typical Attenuation Accuracy vs. Attenuation settings over Temperature

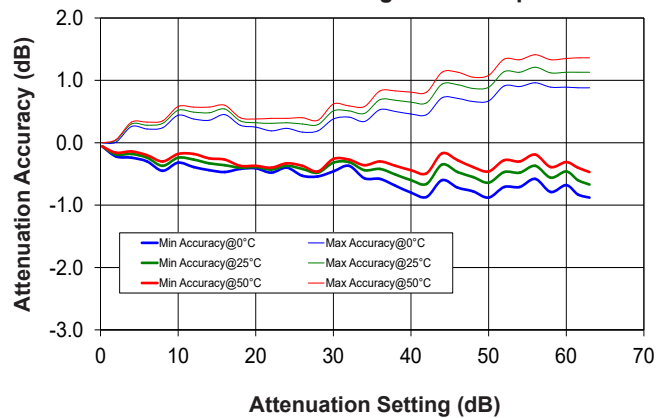

Typical Performance Curves between channels

Attenuation Accuracy @ 20dB setting vs. Frequency at four channels

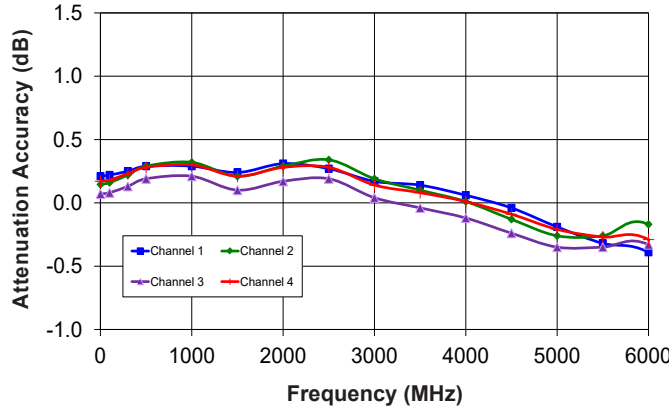

Attenuation Accuracy @ 40dB setting vs. Frequency at four channels

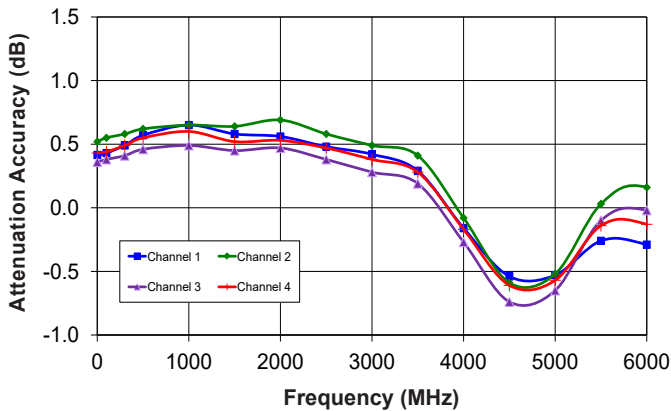

Attenuation Accuracy @ 60dB setting vs. Frequency at four channels

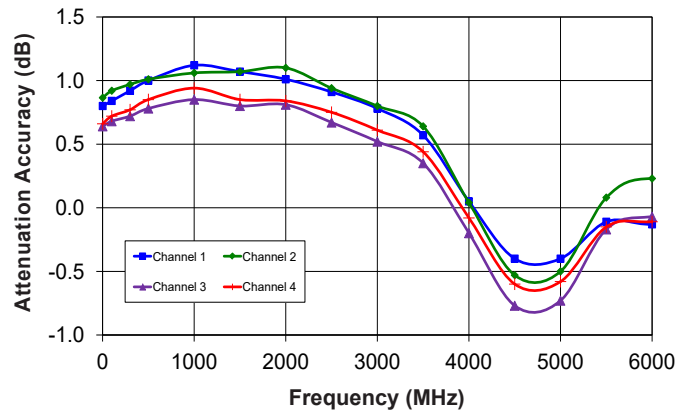

Isolation between RF In 1 and RF In 2 vs. Frequency @ 0dB atten. setting

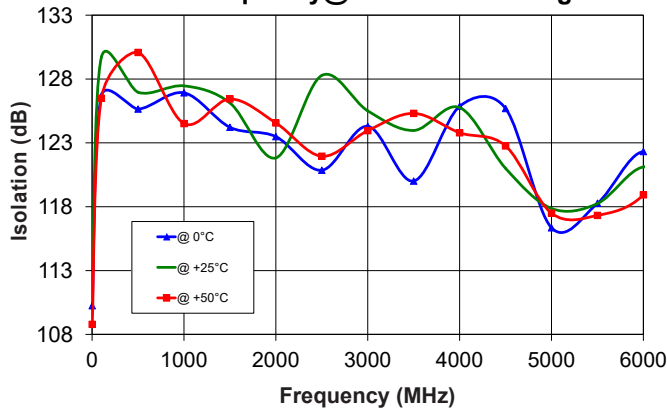

Isolation between channels vs. Frequency

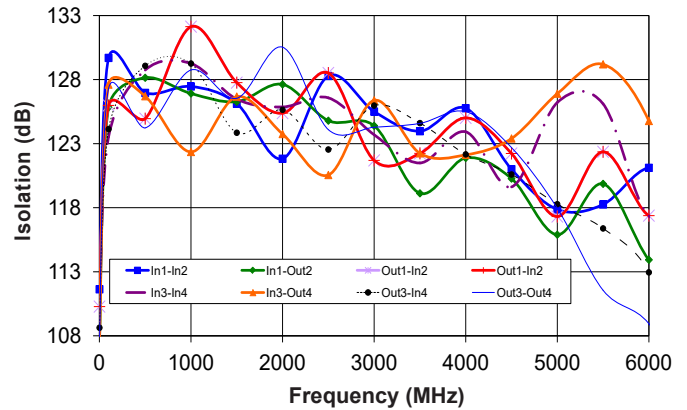

Software & Documentation Download:

- Mini-Circuits' full software and support package including user guide, Windows GUI, DLL files, programming manual and examples can be downloaded free of charge from <http://www.minicircuits.com/softwaredownload/patt.html>
- Please contact testsolutions@minicircuits.com for support

Minimum System Requirements

Parameter	Requirements	
Interface	USB HID or HTTP Get/Post or Telnet protocols or SSH protocols	
System requirements	GUI:	Windows 32 & 64 bit systems from Windows 98 up to Windows 10
	USB API (ActiveX & .Net)	Windows 32 & 64 bit systems with ActiveX or .Net support from Windows 98 up to Windows 10
	USB direct programming support	Linux, Windows systems from Windows 98 up to Windows 10
	HTTP, Telnet or SSH	Any computer with a network port and Ethernet-TCP/IP (HTTP, Telnet or SSH protocols) support
Hardware	Pentium® II or higher, RAM 256 MB	

Graphical User Interface (GUI) for Windows

Key Features:

- Manual attenuation setting
- Sweep and Hop attenuation sequences directed from the PC, or entire sequence loaded into RC4DAT.
- Attenuator address configuration and Firmware upgrade
- Attenuation at power up may be set to selected attenuation level or last attenuation state recorded.
- USB, HTTP or Telnet control of RC4DAT
- Setting Ethernet configuration

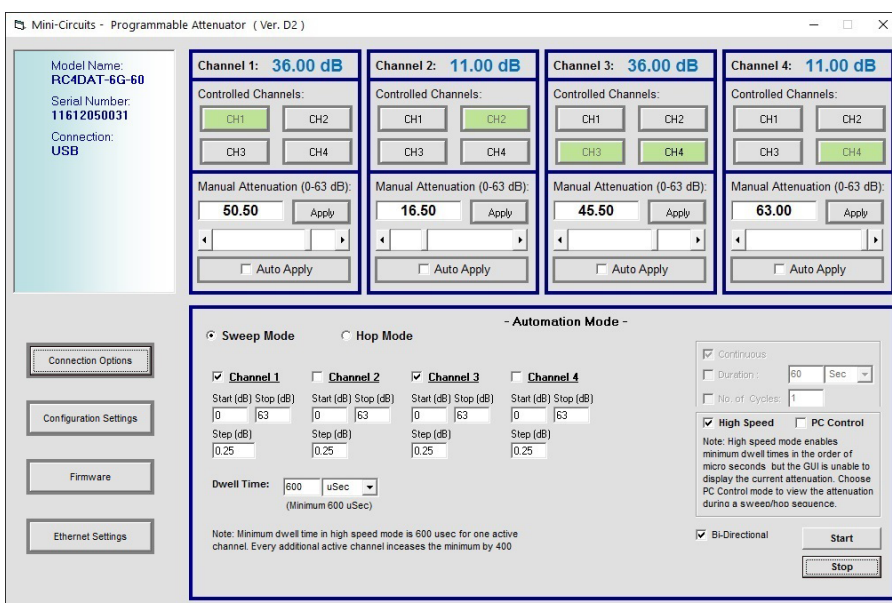

Application Programming Interface (API)

Programming manual: https://www.minicircuits.com/softwaredownload/Prog_Manual-6-Programmable_Attenuator.pdf

Windows Support:

- API DLL files exposing the full switch functionality
 - ActiveX COM DLL file for creation of 32-bit programs
 - .Net library DLL file for creation of 32 / 64-bit programs
- Supported by most common programming environments (refer to application note [AN-49-001](#) for summary of tested environments)

Linux Support:

- Full attenuator control in a Linux environment is achieved by way of USB interrupt commands.

Ordering Information

Model	Description
RC4DAT-6G-60	USB/Ethernet four channel Programmable Attenuator

Included Accessories	Part No.	Description
	MUSB-CBL-3+	3.3 ft (1.0 m) USB Cable: USB type A(Male) to USB type Mini-B(Male)

Optional Accessories	Description
USB-AC/DC-5	AC/DC 5V _{DC} Power Adapter with US, EU, IL, UK, AUS, and China power plugs ^{12,13}
MUSB-CBL-3+	3.3 ft (1.0 m) USB Cable: USB type A(Male) to USB type Mini-B(Male)
MUSB-CBL-7+	6.6 ft (2.0 m) USB Cable: USB type A(Male) to USB type Mini-B(Male)
CBL-RJ45-MM-5+	5 ft (1.5 m) Ethernet cable: RJ45(Male) to RJ45(Male) Cat 5E cable
BKT-355-02+	Bracket kit including 3.75" x 5.17" bracket, mounting screws and washers
RKT-RC4DAT	Rack-mounting bracket (19" width, 3U height) for up to 8 x RC4DAT-6G-xx 4-channel attenuators, including all required accessories for mounting within a rack cabinet. Please contact testsolutions@minicircuits.com for details.

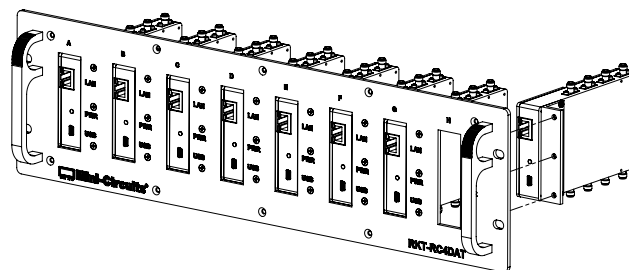

¹² The USB-AC/DC-5 may be used to provide the 5V_{DC} power input via USB port if operating the RC4DAT with Ethernet control. Not required if using USB control.

¹³ Power plugs for other countries are also available, if you need a power plug for a country not listed please contact testsolutions@minicircuits.com

Additional Notes

- A. Performance and quality attributes and conditions not expressly stated in this specification document are intended to be excluded and do not form a part of this specification document.
- B. Electrical specifications and performance data contained in this specification document are based on Mini-Circuit's applicable established test performance criteria and measurement instructions.
- C. The parts covered by this specification document are subject to Mini-Circuits standard limited warranty and terms and conditions (collectively, "Standard Terms"); Purchasers of this part are entitled to the rights and benefits contained therein. For a full statement of the Standard Terms and the exclusive rights and remedies thereunder, please visit Mini-Circuits' website at www.minicircuits.com/MCLStore/terms.jsp