



Programmable Attenuator RCDAT-44G-30

50Ω 0.1 to 44 GHz 0 to 31.5 dB 0.5 dB step 2.92 mm-Female

THE BIG DEAL

- Precision attenuation up to 44 GHz
- Fine resolution, 0.5 dB
- Fast transitions, 100 μs
- USB and Ethernet control
- Daisy-chain control of up to 25 units



Generic photo used for illustration purposes only

APPLICATIONS

- Transmission loss simulation
- 5G network infrastructure
- Microwave point to point links
- VHF / UHF / L / S / C / X / Ku / K band testing

FUNCTIONAL BLOCK DIAGRAM

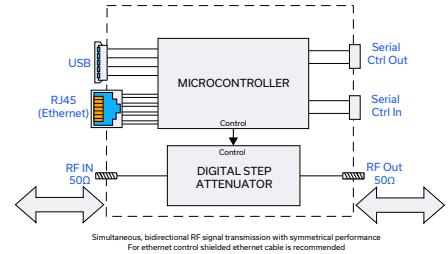

PRODUCT OVERVIEW

Mini-Circuits' RCDAT-44G-30 is a precision programmable attenuator covering an extremely wide bandwidth, from 0.1 to 44 GHz. Its unique design allows attenuation settings to be programmed from 0 to 31.5 dB, in 0.5 dB steps with monotonic attenuation change per dB, even at the highest frequencies and attenuation settings.

The attenuator can be controlled via USB or Ethernet, allowing control directly from a PC, or remotely over a network. Full software support is provided, including our user-friendly GUI application for Windows and a full API with programming instructions for Windows and Linux environments (both 32-bit and 64-bit systems).

This model also includes Mini-Circuits' novel dynamic addressing daisy-chaining interface which allows multiple RCDAT-44G-30 attenuators to be connected together into a Master / Slave chain, with independent control of each attenuator channel through the single USB or Ethernet connection of the master unit.

KEY FEATURES

Feature	Advantages
Extremely wide bandwidth	A single attenuator covers a diverse range of RF and microwave applications from 0.1 to 44 GHz.
Daisy chain control (dynamic addressing)	Simplify control software and interconnections by cascading up to twenty-five modules for control through a single USB or Ethernet interface.
USB & Ethernet control	USB HID and Ethernet (HTTP / Telnet) interfaces provide easy compatibility with a wide range of software setups and programming environments
Programmable attenuation sweep and Hop sequences	The RCDAT-44G-30 can be programmed with a timed sequence of attenuation settings, to run without any additional external control.
Full software support	User friendly Windows GUI (graphical user interface) allows manual control straight out of the box, while the comprehensive API (application programming interface) with examples and instructions allows easy automation in most programming environments. For details and download link see https://www.minicircuits.com/softwaredownload/patt.html

Trademarks: Windows is a registered trademark of Microsoft Corporation in the United States and other countries. Linux is a registered trademark of Linus Torvalds. Mac is a registered trademark of Apple Corporation. Pentium is a registered trademark of Intel Corporation. Neither Mini-Circuits nor the Mini-Circuits RCDAT-series attenuators are affiliated with or endorsed by the owners of the above-referenced trademarks.

Mini-Circuits and the Mini-Circuits logo are registered trademarks of Scientific Components Corporation.

REV. OR
ECO-021008
RCDAT-44G-30
MCL NY
240314





Programmable Attenuator **RCDAT-44G-30**

ELECTRICAL SPECIFICATION¹ AT +25°C

Parameter	Frequency (GHz)	Min.	Typ.	Max.	Units
Insertion Loss @ 0 dB	0.1 - 15	-	3.00	-	dB
	15 - 35	-	6.00	-	
	35 - 44	-	8.50	-	
Attenuation level @ 0.5 dB Attenuation Setting	0.1 - 15	-	0.50 ± 0.15	-	dB
	15 - 35	-	0.30 ± 0.15	-	
	35 - 44	-	0.30 ± 0.15	-	
Attenuation level @ 1 dB Attenuation Setting	0.1 - 15	-	0.80 ± 0.25	-	dB
	15 - 35	-	0.70 ± 0.3	-	
	35 - 44	-	0.6 ± 0.3	-	
Attenuation level @ 2 dB Attenuation Setting	0.1 - 15	-	2.20 ± 0.3	-	dB
	15 - 35	-	2.30 ± 0.4	-	
	35 - 44	-	2.50 ± 0.6	-	
Attenuation level @ 4 dB Attenuation Setting	0.1 - 15	-	4.00 ± 0.15	-	dB
	15 - 35	-	4.00 ± 0.2	-	
	35 - 44	-	4.00 ± 0.3	-	
Attenuation level @ 8 dB Attenuation Setting	0.1 - 15	-	8.0 ± 0.3	-	dB
	15 - 35	-	8.0 ± 0.5	-	
	35 - 44	-	8.5 ± 0.6	-	
Attenuation level @ 16 dB Attenuation Setting	0.1 - 15	-	16.0 ± 0.6	-	dB
	15 - 35	-	16.50 ± 0.7	-	
	35 - 44	-	17.0 ± 0.9	-	
Attenuation level @ 31.5 dB Attenuation Setting	0.1 - 15	-	32 ± 1.0	-	dB
	15 - 35	-	32.5 ± 1.5	-	
	35 - 44	-	32.0 ± 1.7	-	
Input IP3 ²	2 - 16	-	+50	-	dBm
Input Power @ 1 dB Compression	0.1 - 44	+22	-	-	dBm
VSWR	0.1 - 25	-	1.3	2.5	:1
	25 - 44	-	1.5	2.5	
Min Dwell Time ³	0.1 - 44	-	600	-	μs
Attenuation Transition Time ⁴	0.1 - 44	-	100	-	μs
Supply Voltage	-	+3.25	+3.5	+4.75	V
DC current drawn ⁵	Ethernet enabled	-	400	450	mA
	Ethernet disabled	-	250	300	

1. Attenuator RF ports are interchangeable, and support simultaneous, bidirectional signal transmission, however the specifications are guaranteed for the RF In and RF Out as noted on the label. There may be minor changes in performance when injecting signals to the RF Out port.
2. Tested with 1 MHz offset between signals.
3. Minimum Dwell Time is the shortest delay possible between settling on one attenuation level to settling on the next, in response to a command to change state (excluding communication protocol delays).
4. Attenuation Transition Time is specified as the time between starting to change the attenuation state and settling on the requested attenuation state.
5. DC current consumption shown for a single attenuator, without any slaves connected in series.

ABSOLUTE MAXIMUM RATINGS

Operating Temperature	0°C to +50°C
Storage Temperature	-20°C to +85°C
V _{USB} Max.	+6 V
RF power for RF In	+28 dBm
DC voltage at RF port	+10 V

Permanent damage may occur if any of these limits are exceeded operating in the range between operating power limits and absolute maximum ratings for extended periods of time may result in reduced life and reliability.



Programmable Attenuator **RCDAT-44G-30**

50Ω 0.1 to 44 GHz 0 to 31.5 dB 0.5 dB step 2.92 mm-Female

TYPICAL PERFORMANCE GRAPHS AT +25°C

INSERTION LOSS

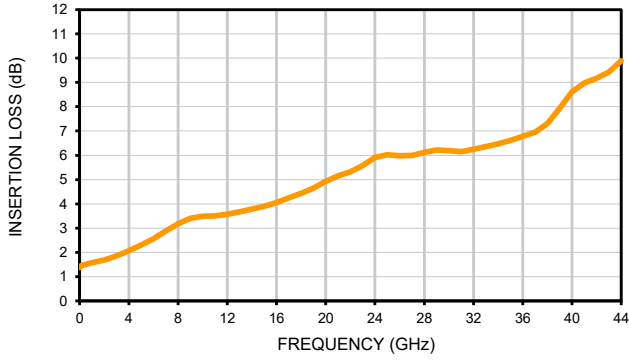

ATTENUATION RELATIVE TO INSERTION LOSS OVER ATTENUATION SETTINGS

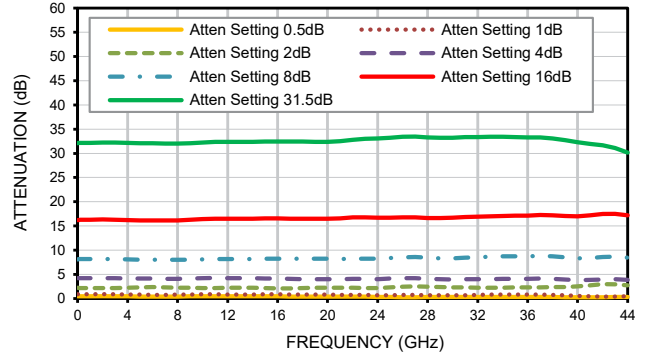

INPUT VSWR OVER ATTENUATION SETTINGS

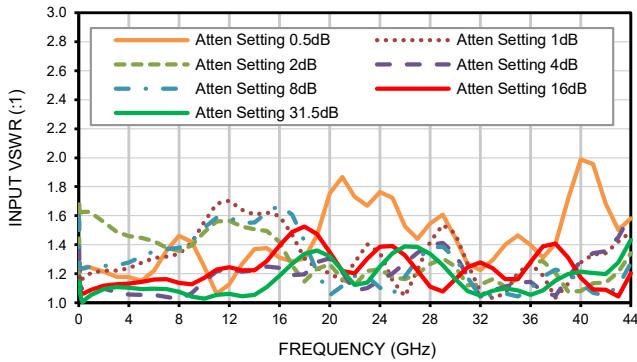

OUTPUT VSWR OVER ATTENUATION SETTINGS

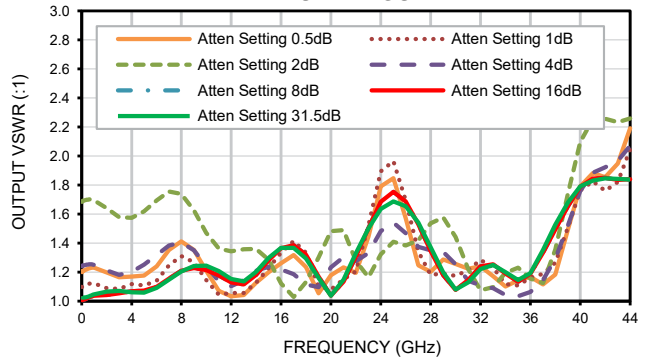



Programmable Attenuator **RCDAT-44G-30**

CONTROL INTERFACES

Ethernet Control	Supported Protocols	TCP / IP, HTTP, Telnet, DHCP, UDP (limited)
	Max Data Rate	10 Mbps (10 Base-T Half Duplex)
USB Control	Supported Protocols	HID - Full Speed
	Min Communication Time ⁶	3 ms typ

6. Based on the polling interval of the USB HID protocol (1 ms with 64 bytes per packet) and no other significant CPU or USB activity

SOFTWARE & DOCUMENTATION

Mini-Circuits' full software and support package including user guide, Windows GUI, API, programming manual and examples can be downloaded free of charge (refer to the last page for the download path).

A comprehensive set of software control options is provided:

- GUI for Windows – Simple software interface for control via Ethernet and USB
- Programming / automation via Ethernet
 - Complete set of control commands which can be sent via any supported protocol – simple to implement in the majority of modern programming environments
- Programming / automation via USB
 - DLL files provide a full API for Windows with a set of intuitive functions which can be implemented in any programming environment supporting .Net Framework or ActiveX
 - Direct USB programming is possible in any other environment (not supporting .Net or ActiveX)

Please contact testsolutions@minicircuits.com for support

MINIMUM SYSTEM REQUIREMENTS

Hardware	Intel i3 (or equivalent) or later
GUI (USB or Ethernet Control)	Windows 7 or later
USB API DLL	Windows 7 or later with support for Microsoft .Net Framework or ActiveX
USB Direct Programming	Windows 7 or later; Linux
Ethernet	Windows, Linux or macOS with Ethernet TCP / IP support



Programmable Attenuator **RCDAT-44G-30**

50Ω 0.1 to 44 GHz 0 to 31.5 dB 0.5 dB step 2.92 mm-Female

CONTROLLING MULTIPLE MODULES IN GUI PROGRAM

Connect the attenuator you wish to use as master to either USB or LAN and connect additional units to the master using the serial control in/out ports and CBL-1.5FT-MMD+ or equivalent control cables, then start the GUI and select the control method you wish to use (USB, HTTP or Telnet, RS232 is not available in this model)

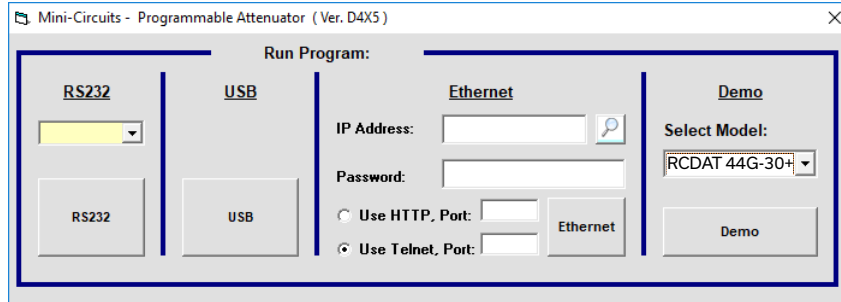

RCDAT GUI initial (control selection) screen

Once you've selected the control method the main attenuation control screen will appear, allowing you to set a fixed attenuation, an arbitrary sequence of attenuation steps, or a sweep(ramp) of attenuation for each attenuator, or for a number of attenuators at once.

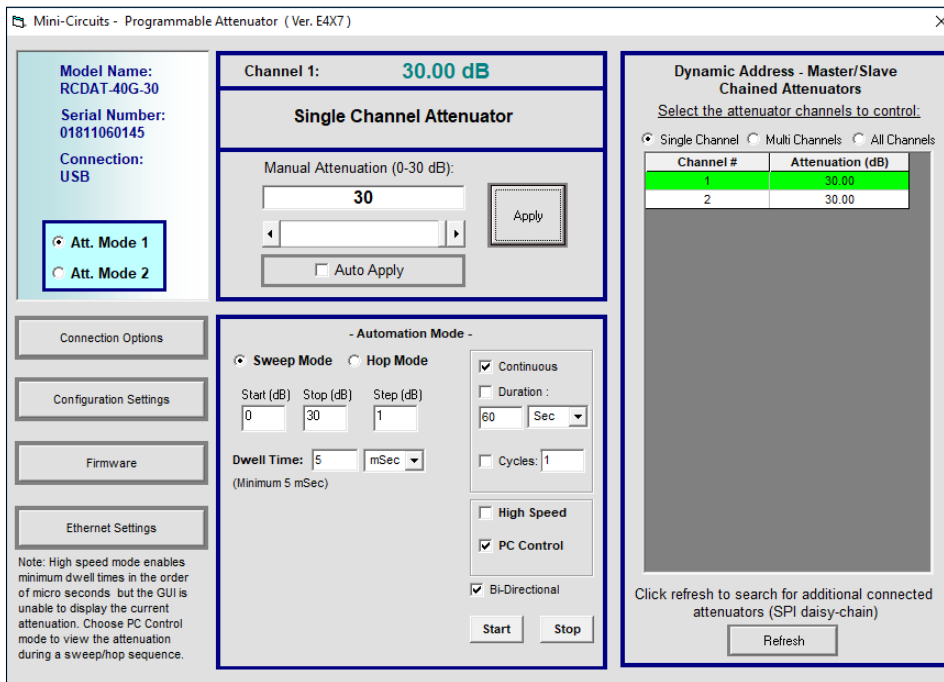

RCDAT GUI main screen (USB control) of single unit.



Programmable Attenuator **RCDAT-44G-30**

50Ω 0.1 to 44 GHz 0 to 31.5 dB 0.5 dB step 2.92 mm-Female

CONNECTING MULTIPLE MODULES (DAISY CHAIN)

The RCDAT-44G-30 is designed to connect up to 25 modules in series (Daisy chain) using dynamic addressing, meaning there is no need to specifically set the address of the modules, the addresses will be set automatically as part of establishing the communications with the PC. The module connected to the PC USB port or LAN connection will be assigned address 0 (Master), the first module connected to it will get address 1(slave) and subsequent modules incrementing up to address 24 (slave).

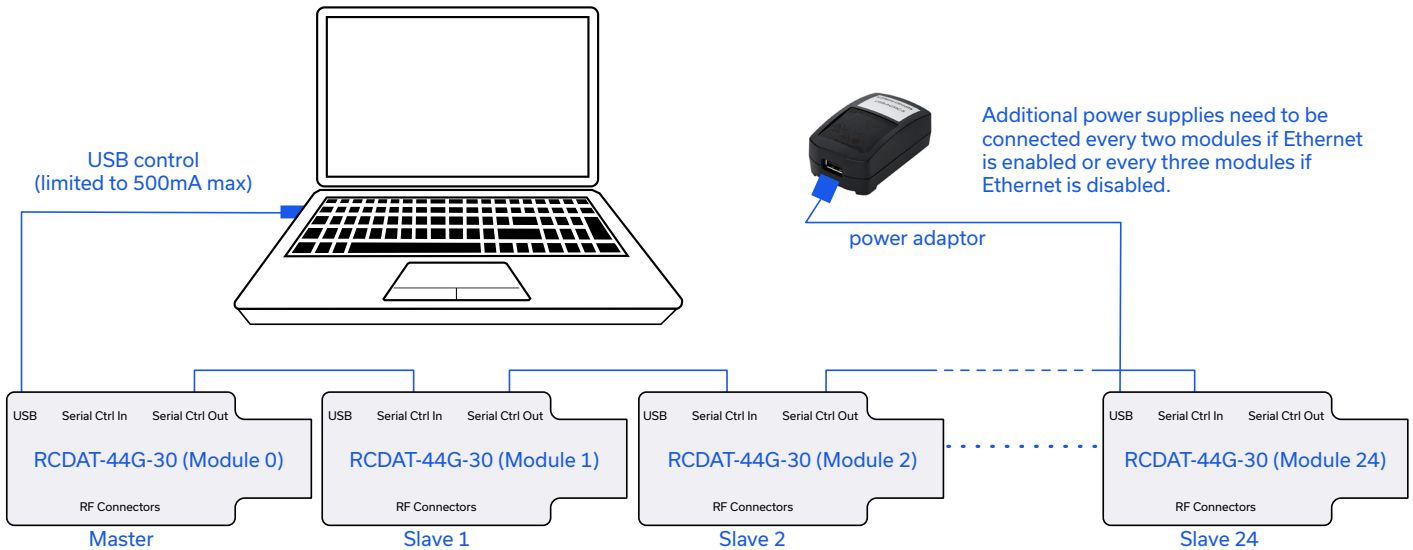

Connections between modules will be made using the serial in/out ports with the module connected to the PC as a master and all other as slave modules. All control will be through the master module (address zero) which is the only one communicating with the PC (via USB or Ethernet). Serial control out port of each module should be connected to the serial control in port of the next module. Power can be supplied from the PC via the master module or from additional power supplies connected to the USB ports of slave units.

Note that with Ethernet enabled each unit will draw up to 450 mA so to connect three units in series you will need to supply 1350mA, thus it is recommended to turn off the Ethernet circuitry in the slave units to reduce the power requirements. Connecting an additional power supply will automatically cut off power draw from the serial control in port for the module connected.

The Serial master/slave bus allows connecting modules of different types to the same daisy chain as long as all support Mini-Circuits dynamic addressing setup. To add a new module to the set up simply connect the module to the setup and refresh the address listing, no need to reset any of the existing modules or assign addresses manually.

Note: Different module types may have different current consumption which will change the number of units which can be connected before additional power supply is needed.



Programmable Attenuator **RCDAT-44G-30**

50Ω 0.1 to 44 GHz 0 to 31.5 dB 0.5 dB step 2.92 mm-Female

RCDAT RESPONSE TO COMMUNICATION INTERRUPT

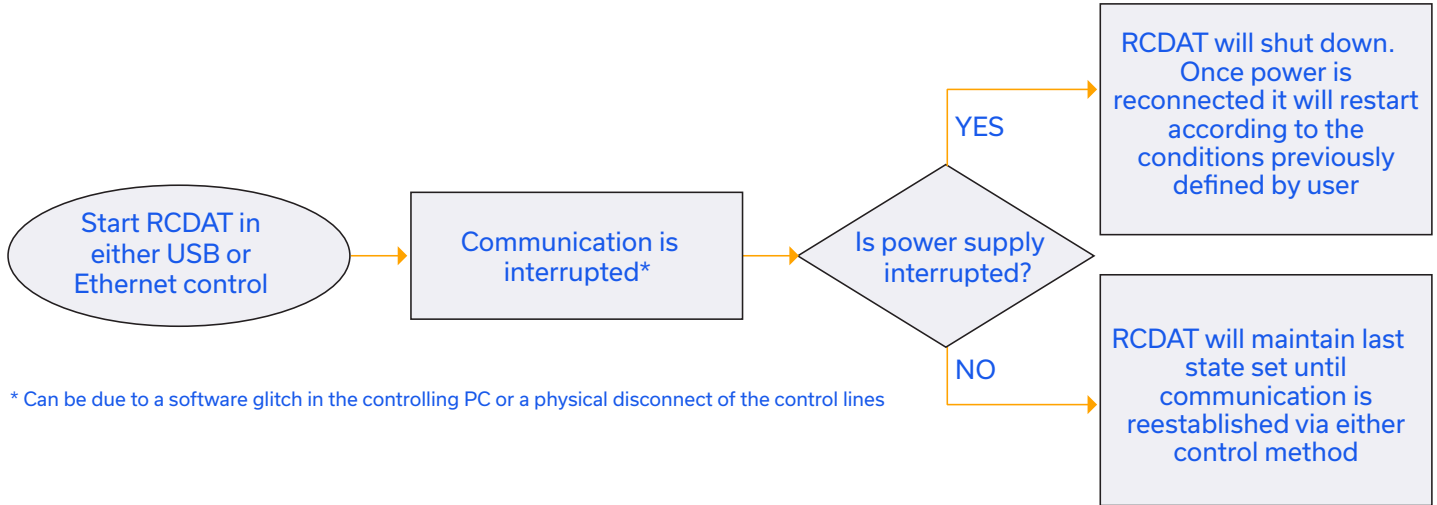

BLOCK DIAGRAM

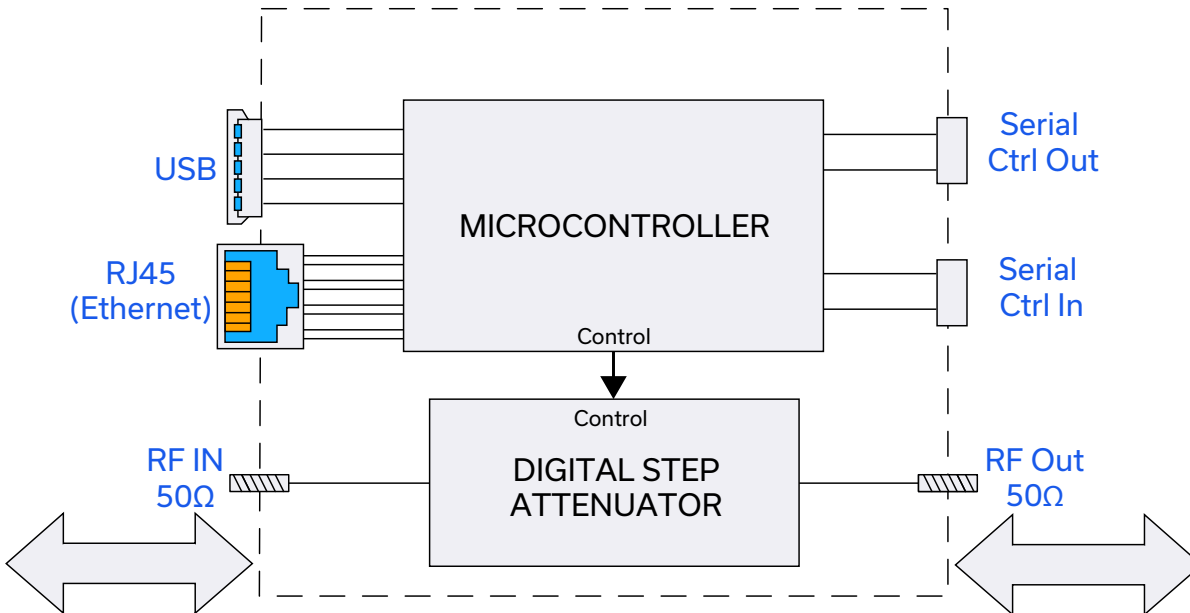

Simultaneous, bidirectional RF signal transmission with symmetrical performance
For ethernet control shielded ethernet cable is recommended



Programmable Attenuator **RCDAT-44G-30**

50Ω 0.1 to 44 GHz 0 to 31.5 dB 0.5 dB step 2.92 mm-Female

CASE STYLE DRAWING

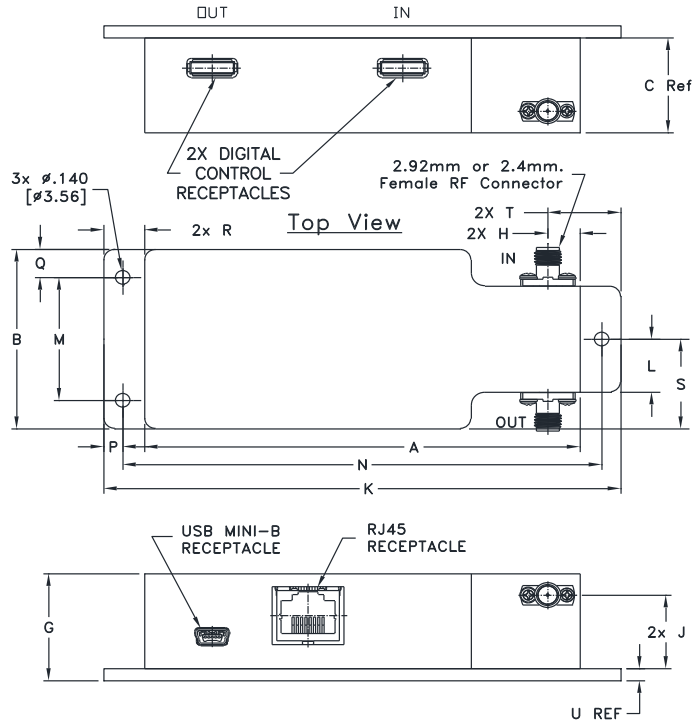

OUTLINE DIMENSIONS (Inches / mm)

A	B	C	D	E	F	G	H	J	K	L	M	N	P	Q	R	S	T	U	wt
4.00	1.75	0.92	--	--	--	--	0.30	0.72	4.75	0.52	1.20	4.40	0.18	0.28	0.38	0.87	0.67	0.12	grams
101.60	44.45	23.49	--	--	--	--	7.54	18.19	120.65	13.11	30.45	111.76	4.45	6.99	9.53	22.20	17.06	3.00	520.0

CONNECTIONS

RF In	(2.92mm female)
RF Out	(2.92mm female)
USB	(USB type Mini-B female)
Network (Ethernet/LAN)	(RJ45 socket)
Serial Control Out	(10 Pin Digital Snap Fit female) ⁷
Serial Control In	(10 Pin Digital Snap Fit female) ⁷

7. Mating connector is Hirose ST40X-10S-CV(30)



USB & ETHERNET

Programmable Attenuator **RCDAT-44G-30**

Mini-Circuits

50Ω 0.1 to 44 GHz 0 to 31.5 dB 0.5 dB step 2.92 mm-Female

DETAILED MODEL INFORMATION IS AVAILABLE ON OUR WEBSITE [CLICK HERE](#)





Case Style	MS2523	
Software, User Guide & Programming Manual	www.minicircuits.com/softwaredownload/patt.html	
Environmental Rating	ENV5T1	
Regulatory Compliance	 <p>Refer to our website for compliance methodologies and qualifications</p>	www.minicircuits.com/quality/environmental_introduction.html

Contact Us: testsolutions@minicircuits.com

INCLUDED ACCESSORIES

	Part Number	Description
	MUSB-CBL-3+	2.6 ft (0.8 m) USB Cable: USB type A(Male) to USB type Mini-B (Male)

OPTIONAL ACCESSORIES

	Part Number	Description
	USB-AC/DC-5+	AC/DC 5V _{DC} Power Adapter with US, EU, IL, UK, AUS, and China power plugs ^{8,9}
	MUSB-CBL-AB-7+	6.6 ft (2.0 m) USB Cable: USB type A (Male) to USB type Mini-B(Male)
	CBL-RJ45-MM-5+	5 ft (1.5 m) Ethernet cable: RJ45 (Male) to RJ45(Male) Cat 5E cable
	CBL-1.5FT-MMD+	1.5 ft (0.5 m) Digital Snap Fit(male-male) cable assembly (daisy chain)
	CBL-5FT-MMD+	5 ft (1.5 m) Digital Snap Fit(male-male) cable assembly (daisy chain)

8. The USB-AC/DC-5 may be used to provide the 5V_{DC} power input via USB port if operating the RCDAT with Ethernet control. Not required if using USB control.

9. Power plugs for other countries are also available, Plugs for other countries are also available, if you need a power plug for a country not listed please contact testsolutions@minicircuits.com

- NOTES**
- A. Performance and quality attributes and conditions not expressly stated in this specification document are intended to be excluded and do not form a part of this specification document.
 - B. Electrical specifications and performance data contained in this specification document are based on Mini-Circuit's applicable established test performance criteria and measurement instructions.
 - C. The parts covered by this specification document are subject to Mini-Circuits standard limited warranty and terms and conditions (collectively, "Standard Terms"); Purchasers of this part are entitled to the rights and benefits contained therein. For a full statement of the standard. Terms and the exclusive rights and remedies thereunder, please visit Mini-Circuits' website at www.minicircuits.com/MCLStore/terms.jsp

