



# Directional Coupler

## RDC-7-182-75X+

75Ω 7dB 5 to 1800 MHz

### THE BIG DEAL

- Low mainline loss, 2.0 dB typ. at 1218 MHz
- Good Return Loss, 18 dB
- Excellent coupling flatness, ±0.3 dB
- Supports DOCSIS® 3.1 Systems



Generic photo used for illustration purposes only

CASE STYLE: TT2315

#### +RoHS Compliant

The +Suffix identifies RoHS Compliance. See our website for methodologies and qualifications

### APPLICATIONS

- DOCSIS 3.1
- Cable TV

### PRODUCT OVERVIEW

Mini-Circuits RDC-7-182-75X+ surface-mount directional coupler provides 7 dB coupling with excellent flatness, low mainline loss, and good return loss for 75Ω applications from 5 to 1800 MHz, supporting a variety of broadband applications including DOCSIS 3.1 systems and equipment. This model features core and wire construction with wrap-around terminations for good solderability and easy visual inspection.

### KEY FEATURES

Feature	Advantages
Broadband, 5 to 1800 MHz	Supports bandwidth requirements for DOCSIS 3.1 systems and equipment.
Low mainline loss, 2.0 dB at 1218 MHz	Provides excellent through-path signal transmission and maintains low heat dissipation, avoiding the need for special heat sinking methods.
Power handling, up to 1W	Usable in systems with a variety of signal power requirements.
Excellent return loss, 18 dB typ.	Provides excellent matching for 50Ω systems.
Top Hat® feature	Improves speed and accuracy of pick and place assembly.

REV. C  
ECO-012267  
RDC-7-182-75X+  
WP/CP/AM  
221006



### ELECTRICAL SPECIFICATIONS AT 25°C

Parameter	Condition (MHz)	Min.	Typ.	Max.	Unit
Frequency Range		5		1800	MHz
Mainline Loss <sup>1</sup>	5-1218	—	2.0	2.6	dB
	1218-1800	—	2.7	3.4	
Nominal Coupling	5-1800	—	7.8±0.5	—	dB
Coupling Flatness(±)	5-1800	—	0.3	0.8	dB
Directivity	5-684	16	21	—	dB
	684-1218	10	18	—	
	1218-1800	6	10	—	
Return Loss (Input)	5-1800	—	18	—	dB
Return Loss (Output)	5-1800	—	20	—	dB
Return Loss (Coupled)	5-1800	—	14	—	dB
Input Power	5-1800	—	—	1.0	W

1. Mainline loss includes theoretical power loss at coupled port.

### MAXIMUM RATINGS

Parameter	Ratings
Operating Temperature	-40°C to 85°C
Storage Temperature	-55°C to 100°C

Permanent damage may occur if any of these limits are exceeded.

### ELECTRICAL SCHEMATIC

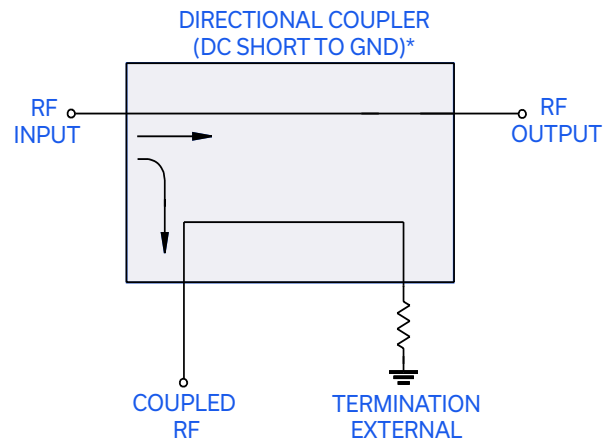

\*Electrical schematic is for Directional coupler with internal transformer(s) and external termination



### PIN CONNECTIONS

Function	Pad Number
INPUT	1
OUTPUT	6
COUPLED	3
GROUND	2
75Ω TERM EXTERNAL	4
ISOLATE (DO NOT USE)	5

### PRODUCT MARKING: WG

### DEMO BOARD MCL P/N: TB-917+ SUGGESTED PCB LAYOUT (PL-452)

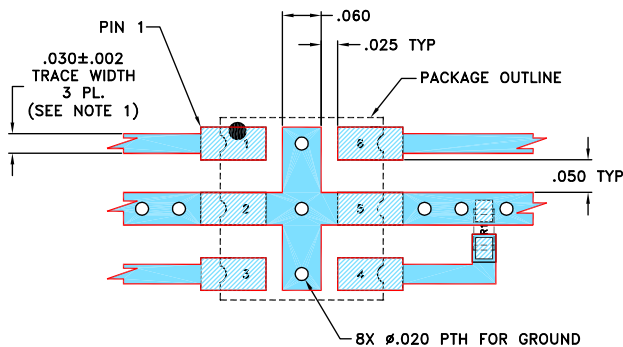

#### NOTES:

- TRACE WIDTH IS SHOWN FOR ROGERS R04350B WITH DIELECTRIC THICKNESS  $.030" \pm .002"$ ; COPPER: 1/2 OZ. EACH SIDE. FOR OTHER MATERIALS TRACE WIDTH MAY NEED TO BE MODIFIED.
- 0603 SIZE CHIP RESISTOR FOOT PRINT SHOWN FOR REFERENCE. FOR RESISTOR VALUE REFER TO TB-917+.
- BOTTOM SIDE OF THE PCB IS CONTINUOUS GROUND PLANE.

DENOTES PCB COPPER LAYOUT WITH SMOBC (SOLDER MASK OVER BARE COPPER)

DENOTES COPPER LAND PATTERN FREE OF SOLDER MASK

### OUTLINE DRAWING

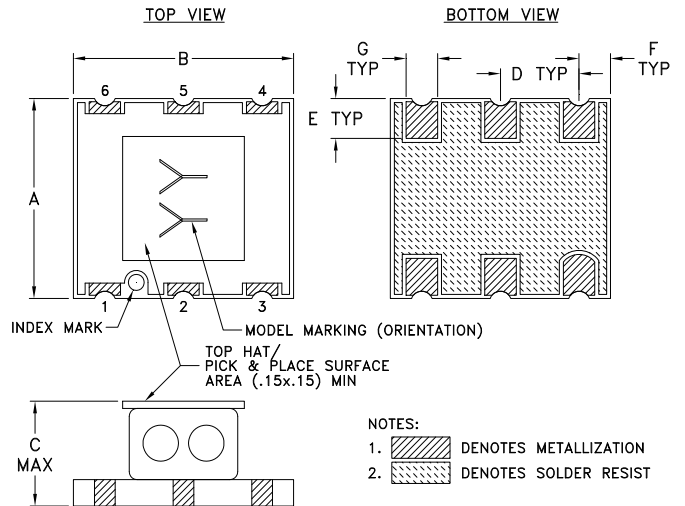

### PCB Land Pattern

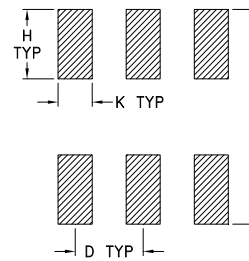

Suggested Layout,  
Tolerance to be within  $\pm .002$

### OUTLINE DIMENSIONS (Inches/mm)

A	B	C	D	E	F	G	H	J	K
.250	.280	.140	.100	.050	.040	.040	.100	.310	.050
6.35	7.11	3.56	2.54	1.27	1.02	1.02	2.54	7.87	1.27

Weight: 0.35 grams

### TAPE & REEL INFORMATION: F34



### TYPICAL PERFORMANCE DATA

Frequency (MHz)	Mainline Loss (dB) In-Out	Coupling (dB) In-Cpl	Directivity (dB)	Return Loss (dB)		
				In	Out	Cpl
5	1.69	7.59	21.46	17.42	23.10	13.30
20	1.58	7.50	24.57	18.98	28.37	14.70
50	1.62	7.54	24.30	18.93	29.57	14.68
100	1.67	7.59	23.79	18.89	29.80	14.62
200	1.71	7.64	23.34	19.10	28.20	14.91
400	1.75	7.64	22.65	19.58	24.30	15.86
800	1.86	7.51	22.30	21.30	21.25	18.70
900	1.90	7.46	22.42	21.35	21.29	19.40
1000	1.96	7.41	22.36	21.51	21.46	20.20
1218	2.12	7.31	20.00	21.09	21.05	21.50
1500	2.44	7.26	15.46	19.38	18.56	19.94
1600	2.58	7.28	14.70	18.40	18.03	18.58
1800	2.96	7.38	13.84	15.94	16.96	16.28

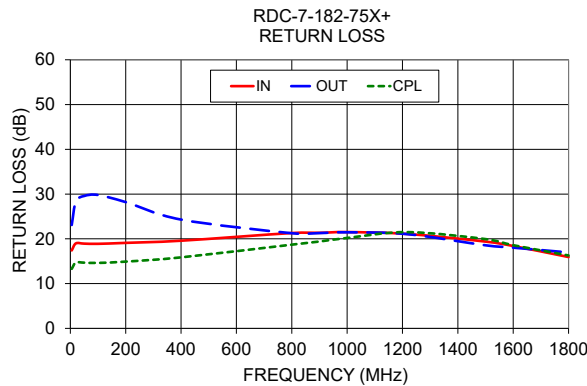
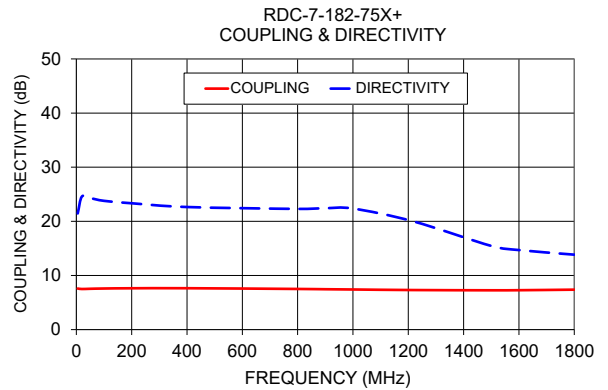
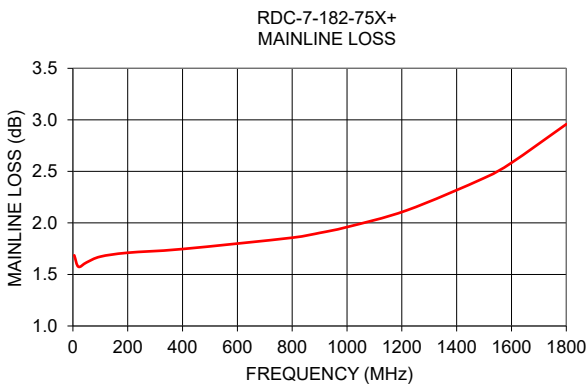

- NOTES**
- A. Performance and quality attributes and conditions not expressly stated in this specification document are intended to be excluded and do not form a part of this specification document.
  - B. Electrical specifications and performance data contained in this specification document are based on Mini-Circuit's applicable established test performance criteria and measurement instructions.
  - C. The parts covered by this specification document are subject to Mini-Circuits standard limited warranty and terms and conditions (collectively, "Standard Terms"); Purchasers of this part are entitled to the rights and benefits contained therein. For a full statement of the standard. Terms and the exclusive rights and remedies thereunder, please visit Mini-Circuits' website at [www.minicircuits.com/MCLStore/terms.jsp](http://www.minicircuits.com/MCLStore/terms.jsp)