



COAXIAL SOLID STATE

High Power Amplifier RFE-24M30M075X+

Mini-Circuits

50Ω 4X 19W 27 MHz 1 SMA Input / 4 SMA Output

THE BIG DEAL

- One input, four 19W outputs
- 27 MHz ISM band
- Suitable for CW and pulsed signals
- High gain, 16 dB typical at P_{3dB}
- 55% typical efficiency
- Integrated harmonic suppression
- Temperature compensated gate bias

APPLICATIONS

- Industrial heating
- Materials processing
- Food processing (heating, tempering, and pasteurization)
- Microwave-assisted chemistry
- Plasma generation
- Plasma surface treatment
- Disinfection
- Chemistry
- RF-excited lasers
- Medical (heating, hyperthermia, and ablation)
- Semiconductor RF generators

PRODUCT OVERVIEW

The RFE-24M30M075X+ is a new generation light weight solid state connectorized power amplifier module. One input signal generates four equal output signals with a typical P_{3dB} of 19W each. The amplifier is intended as a driver for high power 27 MHz amplifiers, such as the RFE-24M30M075X+. The RFE-24M30M075X+ can be used in a wide range of industrial, scientific and medical applications in the 27 MHz ISM band. The amplifier uses state-of-the-art high ruggedness semiconductor technology. The amplifier is capable of amplifying CW and pulsed signals. A temperature compensated gate bias circuit is provided. Mounting holes for an M3 screw are provided to mount the amplifier to a heatsink or cooling plate in larger systems. Easy screw-on power supply connections are provided outside the shield.

KEY FEATURES

Feature	Advantages
75W CW Power	Four equal channels with 19W output power (P_{3dB}) for a wide range of industrial, scientific and medical applications in the 27 MHz ISM band. Designed to drive four RFE-24M30M1K7X+ amplifiers to create a generator with output power >5kW.
High Gain	With only 0.5W of input power and a typical gain of 16 dB at P_{3dB} , only two amplifier stages are needed to generate 5kW.
Harmonic Filtering	Harmonic filtering inside this power amplifier ensures that the final stages receive a clean drive signal.
Temperature Compensated Gate Bias	A temperature compensated gate bias circuit is integrated in the PA.
Easy interfacing	Power supply connections are easily accessible outside the shield.
Small and lightweight	The compact amplifier design (202mm x 118mm x 28mm) is lightweight (608 g) which makes it suitable for integration in high power systems that require multiple amplifiers.
Cooling	The power amplifier can easily be mounted on a heatsink using the provided M3 mounting holes.
Low voltage	The RFE-24M30M075X+ operates over a large 50-66V supply voltage range.



Generic photo used for illustration purposes only

Model No.	RFE-24M30M075X+
Case Style	VU3196
Connectors	1 SMA INPUT / 4 SMA OUTPUT

+RoHS Compliant

The +Suffix identifies RoHS Compliance.
See our website for methodologies and qualifications





COAXIAL SOLID STATE

High Power Amplifier **RFE-24M30M075X+**

Mini-Circuits

50Ω 4X 19W 27 MHz 1 SMA Input / 4 SMA Output

ELECTRICAL SPECIFICATIONS PER CHANNEL AT $T_{\text{MOUNTING BASE}} = +25^{\circ}\text{C}$, $V_{\text{DS}} = 65\text{V}$, 50Ω SYSTEM

Parameter	Symbol	Conditions	Min.	Typ.	Max.	Units
Frequency Range	f			27.12		MHz
Operating Voltage	V_{DS}	27.12 MHz	50	65	66	V
Input Power	P_{IN}	27.12 MHz	-	0.5	1.25	Watts
			-	27	31	dBm
Output Power at 1dB compression	$P_{1\text{dB}}$	27.12 MHz	12	-	-	Watts
			40.8	-	-	dBm
Output Power at 3dB compression	$P_{3\text{dB}}$	27.12 MHz	13.5	-	-	Watts
			41.3	-	-	dBm
Power Gain	G_{p}	$P_{3\text{dB}}$ at 27.12MHz	13	-	-	dB
Efficiency	η	$P_{3\text{dB}}$ at 27.12MHz	48	-	-	%
Input VSWR		$P_{3\text{dB}}$ at 27.12MHz	-	-	1.92	:1
Harmonics (H2 and H3)		$P_{3\text{dB}}$ at 27.12MHz	-	-10	-	dBc

Test conditions: $V_{\text{DS}}=65\text{V}$, $I_{\text{DQ}}=0.04\text{A}$, $f=27.12\text{ MHz}$, $T_{\text{MB}}=25^{\circ}\text{C}$, unless otherwise noted
 All power measurements are performed while using a Mini-Circuits NLP-30+ Low Pass Filter in front of the power sensors.

MAXIMUM RATINGS¹

Parameter	Ratings
Mounting Base Temperature ²	0°C to +65°C
Storage Temperature	0°C to +85°C
DC Voltage	66V
Input RF Power (no damage) ³	+31 dBm

- Specifications apply to CW signals only. Permanent damage may occur if any of these limits are exceeded.
- Mounting Base Temperature is the Temperature of the Aluminum Base Plate.
- CW of +31dBm for 5 minutes maximum



COAXIAL SOLID STATE

High Power Amplifier RFE-24M30M075X+

Mini-Circuits

50Ω 4X 19W 27 MHz 1 SMA Input / 4 SMA Output

OUTLINE DRAWING

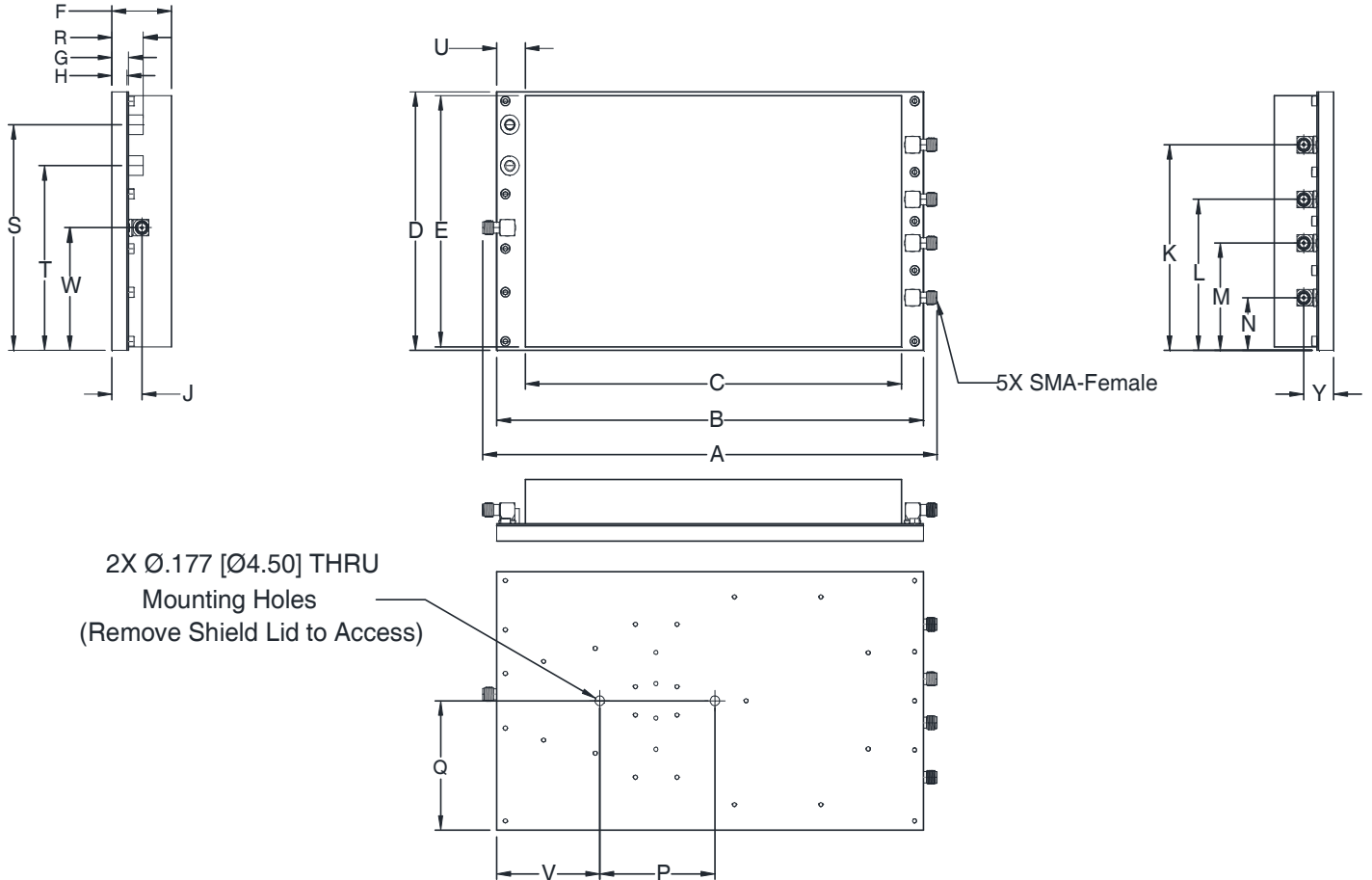

OUTLINE DIMENSIONS (Inch/mm)

CASE #	A	B	C	D	E	F	G	H	J	K	L	M
VU3196	8.486 (215.54)	7.969 (202.40)	7.027 (178.49)	4.660 (118.36)	4.528 (115.00)	1.110 (28.19)	0.310 (7.87)	0.280 (7.11)	.560 (14.24)	3.708 (94.18)	2.724 (69.18)	1.936 (49.18)

CASE #	N	P	Q	R	S	T	U	V	W	Y	WEIGHT (GRAMS)
VU3196	.952 (24.18)	2.151 (54.63)	2.330 (59.18)	.586 (14.89)	4.070 (103.38)	3.330 (84.58)	.534 (13.56)	1.924 (48.87)	2.212 (56.18)	.560 (14.24)	608

Dimensions are in inches (mm). Tolerances: 2Pl. ±.01(0.254); 3Pl. ±.005(0.127)





COAXIAL SOLID STATE

High Power Amplifier **RFE-24M30M075X+**



Mini-Circuits

50Ω 4X 19W 27 MHz 1 SMA Input / 4 SMA Output

TYPICAL ELECTRICAL PERFORMANCE PER CHANNEL OF RFE-24M30M075X+

Parameter	Typical Performance ($T_{MB} = +25^{\circ}C$)	Unit
Frequency	27	MHz
Supply Voltage	65	V
Total Input Power (P_{IN})	27	dBm
CW Output Power (P_{OUT} @ P_{IN}) per Channel	42.8 19	dBm W
Efficiency (@19W per channel)	51.3	%
Gain (@19W per channel)	14.8	dB
Current	2.3	A

AMPLIFIER INTERFACES

	<p>J3 +65V Supply Voltage Connector, M5 J4 Ground Connection, M5</p> <p>Tightening Torque 1.7 N-m (15 in-lbs) with max. of 2.15 N-m (19 in-lbs)</p> <p>Mating Hardware*: M5 screw equivalent to McMaster P/N 92095A308 Belville washer equivalent to McMaster P/N 90895A027 Ring Terminal equivalent to McMaster P/N 7113K29</p>
	<p>J1, J2, J6, J7, J8 - SMA Connector Receptacle, Female Socket 50Ohm</p>

*Mating hardware not included with amplifier. Similar mating hardware available from other manufactures.



COAXIAL SOLID STATE

High Power Amplifier RFE-24M30M075X+

Mini-Circuits

50Ω 4X 19W 27 MHz 1 SMA Input / 4 SMA Output

TYPICAL PERFORMANCE DATA PER CHANNEL AT 27 MHZ ($T_{MOUNTING\ BASE} = +25^{\circ}C, V_{DS} = 65V, 50\Omega\ SYSTEM$)

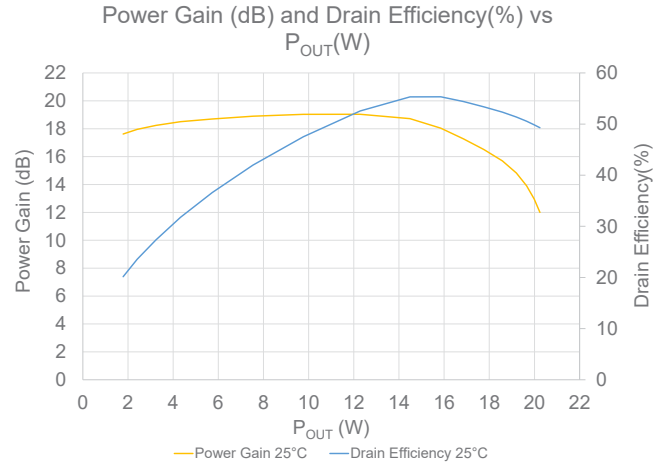
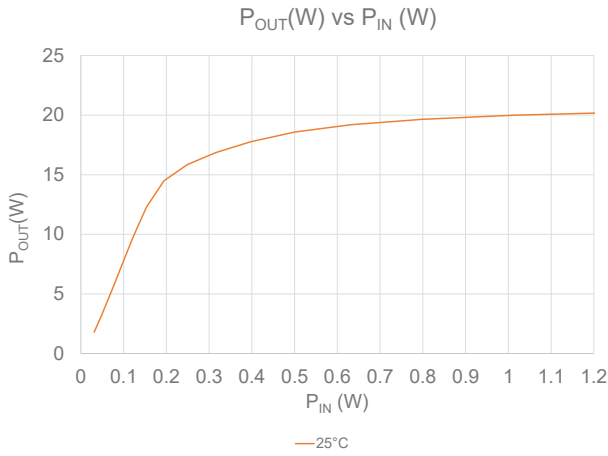

TYPICAL PERFORMANCE DATA PER CHANNEL AT 27 MHZ ACROSS DIFFERENT MOUNTING BASEPLATE TEMPERATURE ($V_{DS} = 65V, 50\Omega\ SYSTEM$)

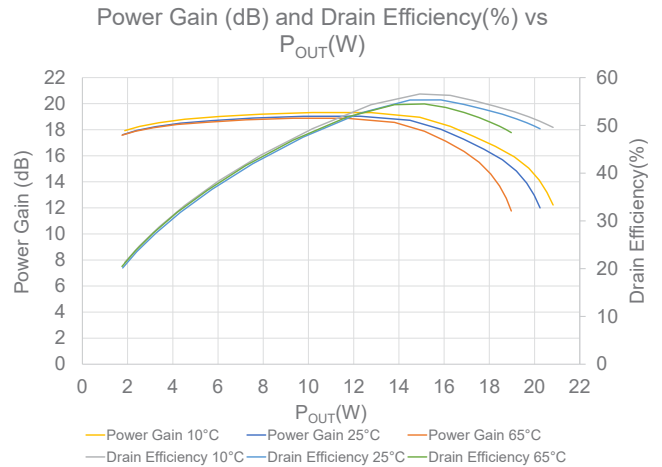
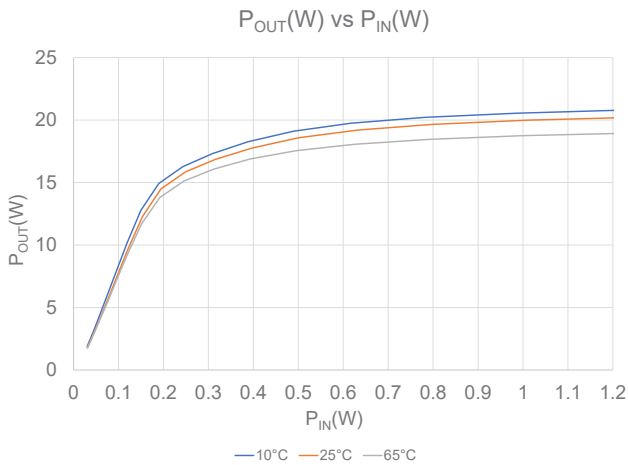

TYPICAL PERFORMANCE DATA PER CHANNEL ACROSS DIFFERENT VOLTAGE RANGE AT 27 MHZ ($T_{MOUNTING\ BASE} = +25^{\circ}C, 50\Omega\ SYSTEM$)

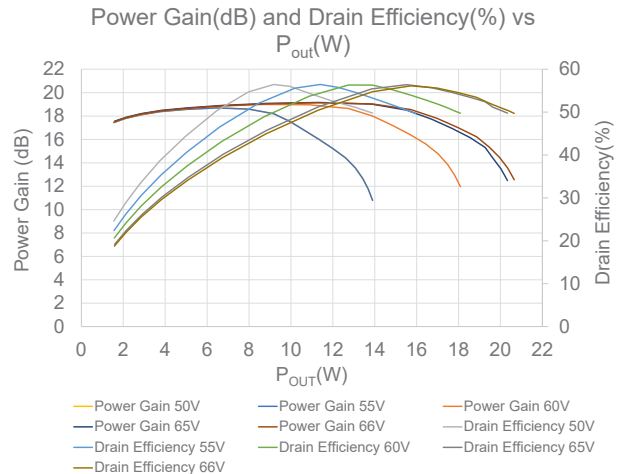
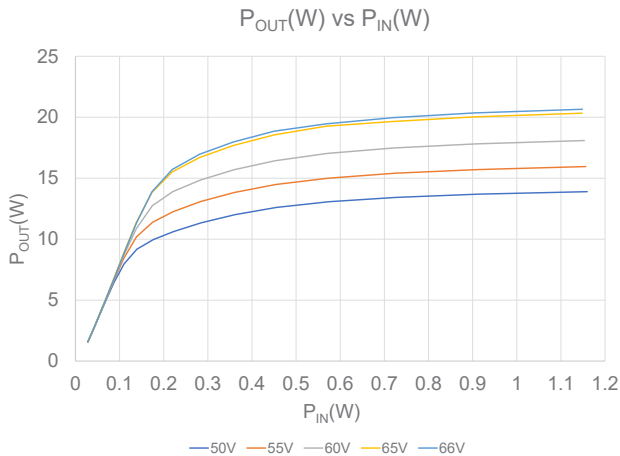



COAXIAL SOLID STATE

High Power Amplifier RFE-24M30M075X+



50Ω 4X 19W 27 MHz 1 SMA Input / 4 SMA Output

TYPICAL PERFORMANCE DATA PER CHANNEL AT 27 MHz ($T_{MOUNTING\ BASE} = +25^{\circ}C, V_{DS} = 65V, 50\Omega\ SYSTEM$)

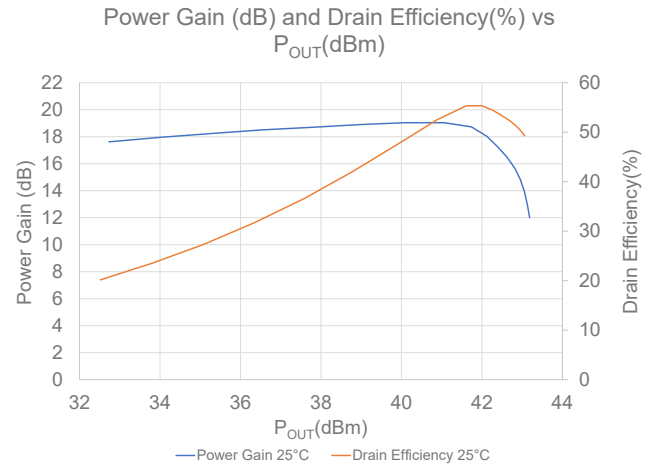
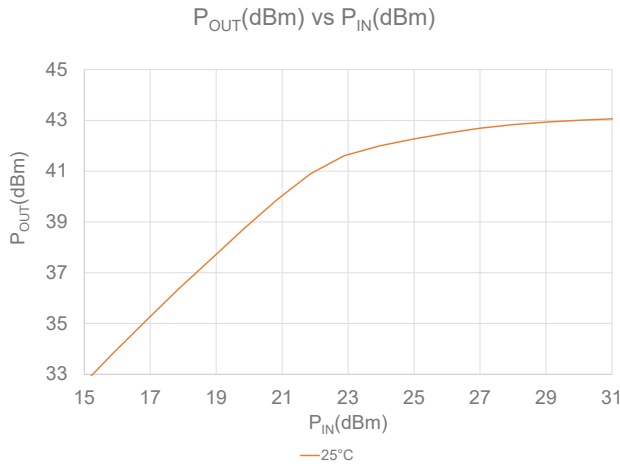

TYPICAL PERFORMANCE DATA PER CHANNEL AT 27 MHz ACROSS DIFFERENT MOUNTING BASEPLATE TEMPERATURE ($V_{DS} = 65V, 50\Omega\ SYSTEM$)

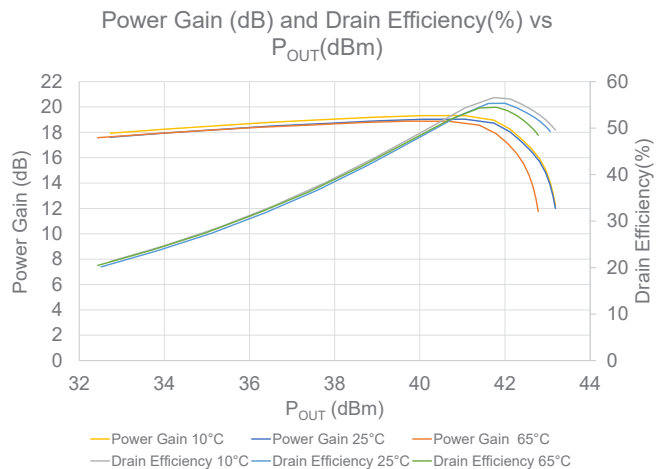
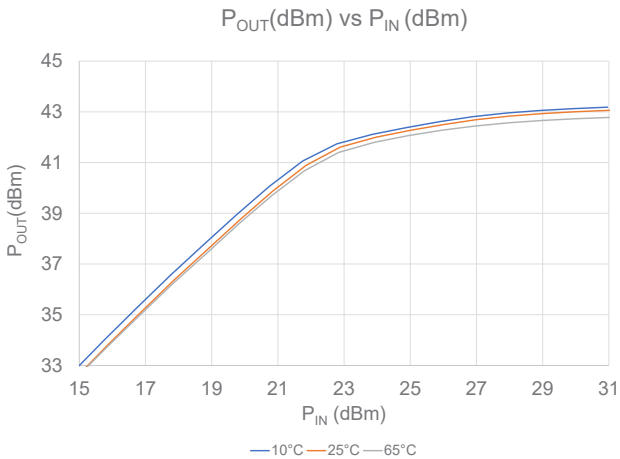

TYPICAL PERFORMANCE DATA PER CHANNEL ACROSS DIFFERENT VOLTAGE RANGE AT 27 MHz ($T_{MOUNTING\ BASE} = +25^{\circ}C, 50\Omega\ SYSTEM$)

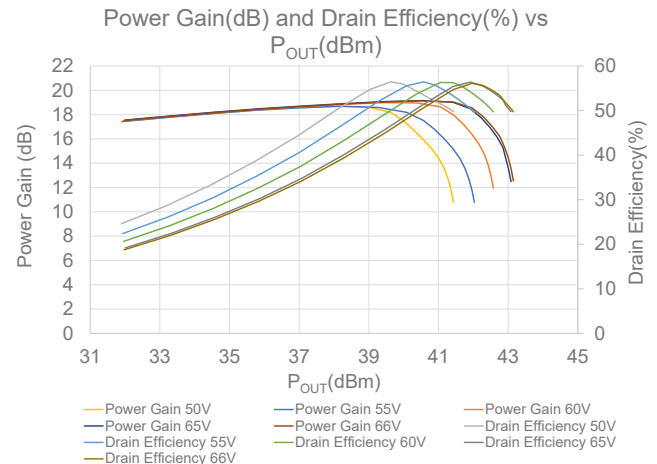
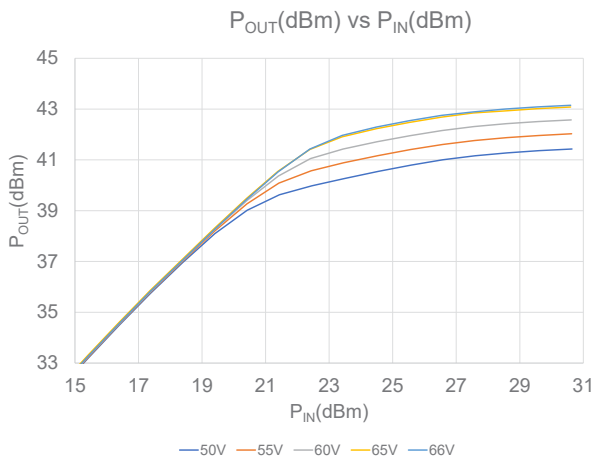



COAXIAL SOLID STATE

High Power Amplifier RFE-24M30M075X+

Mini-Circuits

50Ω 4X 19W 27 MHz 1 SMA Input / 4 SMA Output

TYPICAL PERFORMANCE DATA PER CHANNEL ($T_{\text{MOUNTING BASE}} = +25^{\circ}\text{C}$, $V_{\text{DS}} = 65\text{V}$, 50Ω SYSTEM)

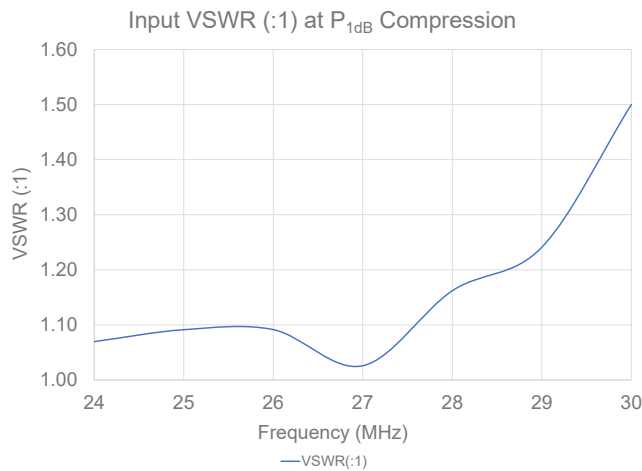
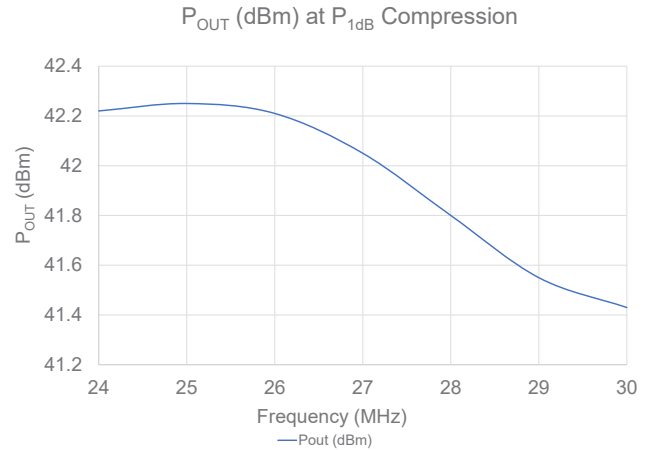
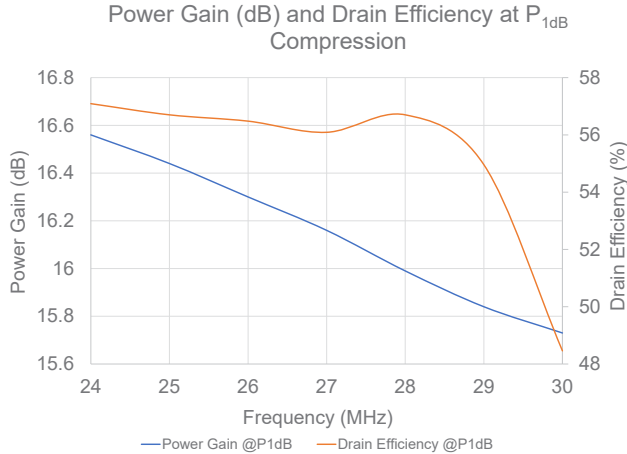



COAXIAL SOLID STATE

High Power Amplifier RFE-24M30M075X+

Mini-Circuits

50Ω 4X 19W 27 MHz 1 SMA Input / 4 SMA Output

TYPICAL PERFORMANCE DATA PER CHANNEL ($T_{\text{MOUNTING BASE}} = +25^{\circ}\text{C}$, $V_{\text{DS}} = 65\text{V}$, 50Ω SYSTEM)

Power Gain (dB) and Drain Efficiency (%) at $P_{3\text{dB}}$ Compression

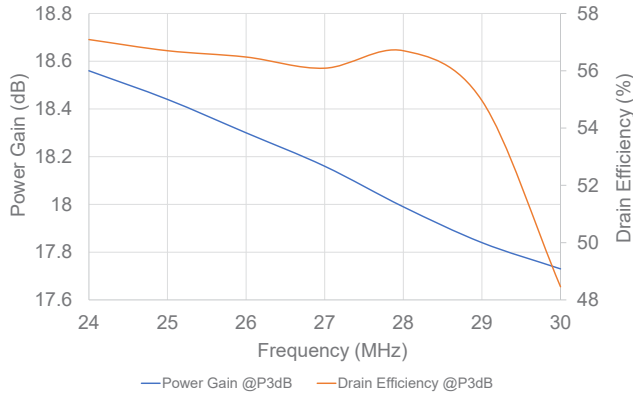

P_{OUT} (dBm) at $P_{3\text{dB}}$ Compression

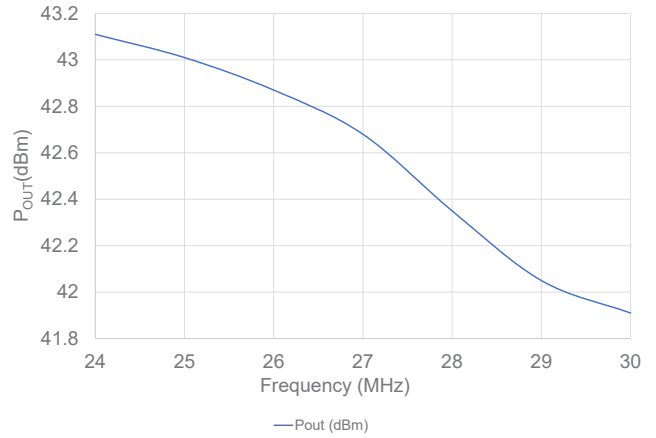

Input VSWR (:1) at $P_{3\text{dB}}$ Compression

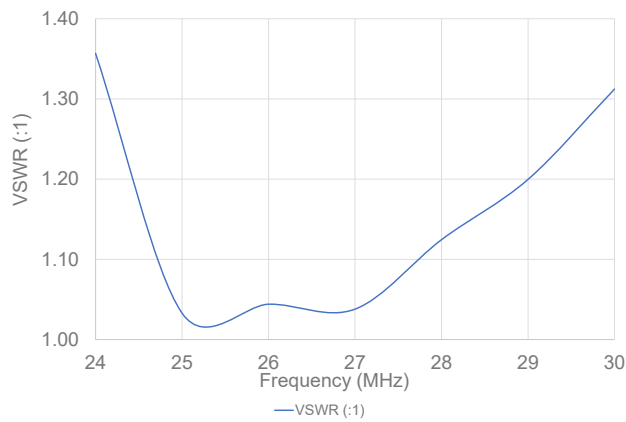



SAFETY INSTRUCTIONS.

WARNING: FAILURE TO FOLLOW THESE INSTRUCTIONS MAY RESULT IN BODILY INJURY, DEATH, OR PROPERTY DAMAGE.

For your own safety, this section provides instructions for avoiding potential dangers when using this product.

QUALIFIED PERSONNEL

This product should be operated by qualified personnel only. Qualified personnel are individuals who are familiar with the operation of the product and the hazards involved with such operation.

DAMAGED OR MISSING HARDWARE

Do not operate the product if there is physical damage or hardware is missing.

MAXIMUM RATINGS

The maximum ratings in this data sheet should never be exceeded. Stress above one or more maximum ratings may cause permanent damage to the product and may permanently and irreversibly affect the quality and reliability of the product, which may increase the risk of bodily injury, death, or property damage.

HAZARDOUS RF VOLTAGES

The RF voltages inside the product and on the center pin of the RF output connector can be hazardous. Contact with the internal components of the product or the center pin of the RF output connector may lead to burns or electrical shock. Disconnect power before removing the protective cover from the product. Note that removing the protective cover from the product will void the express warranty specified in Mini-Circuits Standard Terms.

To reduce the risks presented by these hazards:

1. never operate the product without its protective cover,
2. always connect the RF output connector to a load before the power source is applied to the product, and
3. always place the product in a non-operating condition before disconnecting or connecting the load to the RF output connector.

COOLING

RF Power amplifiers always need proper cooling. Failure to properly cool the product may increase the risk of bodily injury, death, or damage to property or the product.

Some products contain water cooling systems to help cool down the product. If this data sheet indicates that the product contains a water cooling system, proper waterflow as specified in this data sheet is required to keep the temperature of the product within the temperature range that is specified in this data sheet.

Some products also contain built-in protection circuitry designed to shut-off the amplifier at excessive high temperatures or at other excessive operating conditions. Even if this data sheet indicates that the product contains protective circuitry, such protective circuitry is not a substitute for proper handling in accordance with these instructions. Accordingly, do not rely on the protective circuitry to prevent injury or damage to property or the product.

MAINTENANCE CAUTION

Maintenance or repair of the product must only be performed by qualified personnel when the product is in a non-operating condition and disconnected from its power source. Note that performance of maintenance or repairs to the product will void the express warranty specified in Mini-Circuits Standard Terms.

ENVIRONMENTAL CONDITIONS

Unless otherwise stated in this data sheet, this product is designed to be operated under the environmental conditions set forth in this data sheet, as well as the following conditions:

- Indoor use only
- Temperature of 5°C to 40°C (non-condensing)

WARNING SIGNS

In addition to being qualified before operating the product, pay attention to all warning signs and danger symbols. Failure to heed warnings signs and danger symbols, or to follow their associated instructions, may result in bodily injury, death, or property damage.

NOTES

- A. Performance and quality attributes and conditions not expressly stated in this specification document are intended to be excluded and do not form a part of this specification document.
- B. Electrical specifications and performance data contained in this specification document are based on Mini-Circuit's applicable established test performance criteria and measurement instructions.
- C. The parts covered by this specification document are subject to Mini-Circuits standard limited warranty and terms and conditions (collectively, "Standard Terms"); Purchasers of this part are entitled to the rights and benefits contained therein. For a full statement of the standard. Terms and the exclusive rights and remedies thereunder, please visit Mini-Circuits' website at www.minicircuits.com/MCLStore/terms.jsp