



**SURFACE MOUNT**

# RF Transformer

## SCTX2-93-2W+

**Mini-Circuits**

50Ω 10 to 9000 MHz 1:2 Ratio

### THE BIG DEAL

- Super wideband, 10 to 9000 MHz
- Low Insertion Loss, 2.8 dB typ. up to 8 GHz
- Amplitude Unbalance, ±0.9 dB typ. up to 6 GHz
- Good Input Return Loss, 14 dB typ.
- Low Phase Unbalance, ±9° typ.
- Common Mode Rejection, 20 dB typ.



*Generic photo used for illustration purposes only*

CASE STYLE: SN2595

### +RoHS Compliant

The +Suffix identifies RoHS Compliance. See our website for methodologies and qualifications

### APPLICATIONS

- Defense Communication
- Defense Radar
- Line of sight links
- PCS
- Cellular
- Wideband push-pull amplifiers
- ADC (Analog to Digital Converter)
- Balanced Receivers

### PRODUCT OVERVIEW

Mini-Circuits' SCTX2-93-2W+ is a surface-mount transmission line transformer (core and Semi-Rigid cable) covering a very wide frequency range from 10 to 9000 MHz. The transformer provides low insertion loss with excellent phase and amplitude performance. Featuring core and cable construction on a 12-lead PCB unit measures 0.60 x 0.60 x 0.15" accommodating dense circuit board layouts.

### KEY FEATURES

Feature	Advantages
Wideband, 10 to 9000 MHz	Super wide frequency range covers bandwidth requirements for many broadband applications.
Low insertion loss, 2.8 dB	SCTX2-93-2W+ provides excellent signal transmission from input to output with consistent performance across its entire frequency range.
Good Phase and Amplitude Unbalance	Provides good CMRR and IP2.
Small size (0.60 x 0.60 x 0.15")	Provide good solderability and tight layouts.

REV. B  
ECO-019969  
SCTX2-93-2W+  
MCL NY  
240410

**Mini-Circuits**



**SURFACE MOUNT**

# RF Transformer

## SCTX2-93-2W+



50Ω 10 to 9000 MHz 1:2 Ratio

### ELECTRICAL SPECIFICATIONS AT 25°C

Parameter	Frequency (MHz)	Min.	Typ.	Max.	Unit
Impedance Ratio (secondary/primary)			2		
Frequency Range		10		9000	MHz
Insertion Loss (Average)	10 - 3000	—	2.2	3.2	dB
	3000 - 6000	—	3.3	3.9	
	6000 - 8000	—	3.9	4.5	
	6000 - 9000	—	4.1	5.9	
Amplitude Unbalance (±)	10 - 3000	—	0.3	0.6	dB
	3000 - 6000	—	0.7	1.1	
	6000 - 9000	—	1.0	1.5	
Phase Unbalance (±)	10 - 3000	—	3	6	Degree
	3000 - 6000	—	5	9	
	6000 - 9000	—	9	12	
Common mode rejection	10 - 4500	20	25	—	dB
	4500 - 9000	16	20	—	

### ABSOLUTE MAXIMUM RATINGS

Parameter	Ratings
Operating Temperature	-40°C to 85°C
Storage Temperature	-55°C to 100°C
RF Power	2W

Permanent damage may occur if any of these limits are exceeded.

### CONFIGURATION G

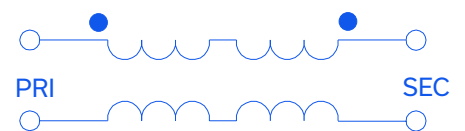



**SURFACE MOUNT**

# RF Transformer

**SCTX2-93-2W+**

Mini-Circuits

50Ω 10 to 9000 MHz 1:2 Ratio

### PIN CONNECTIONS

PRIMARY DOT	12
PRIMARY (GND)	11
SECONDARY DOT	3
SECONDARY	4
GROUND	ALL OTHERS

### OUTLINE DRAWING

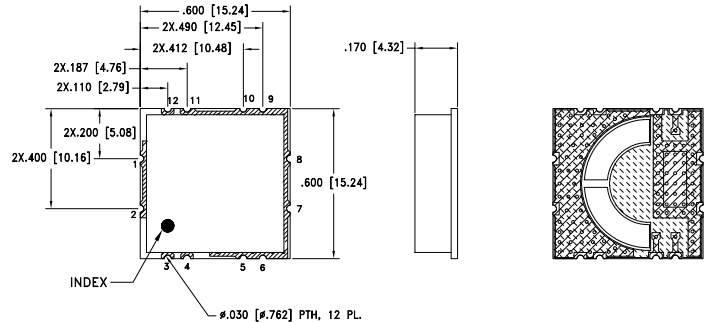

**PRODUCT MARKING:** SCTX2-93-2W+

**DEMO BOARD MCL P/N:** TB-SCTX2-93-2W+  
**SUGGESTED PCB LAYOUT (PL-595)**

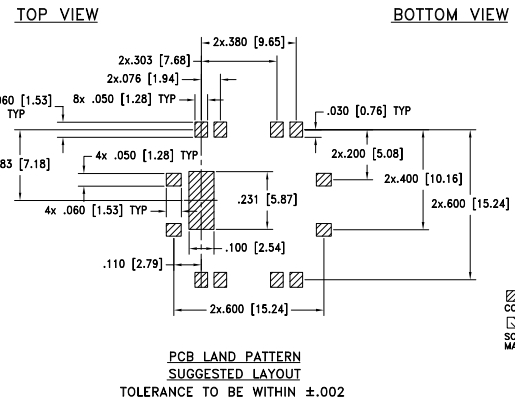
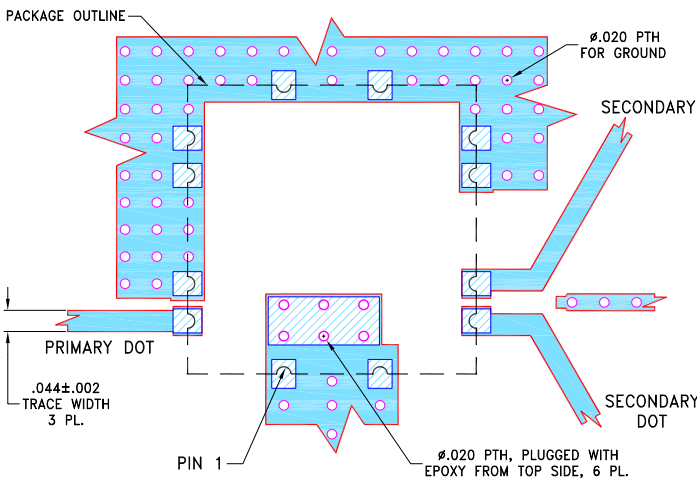

Weight: 1.2 gram  
 Dimensions are in inches [mm]. Tolerances: 3 PL ±.005 Inch

**TAPE & REEL INFORMATION: F95**

**NOTES:**

- TRACE WIDTH IS SHOWN FOR ROGERS RO4350B, WITH DIELECTRIC THICKNESS .020"±.0015". COPPER: 1/2 Oz. EACH SIDE. FOR OTHER MATERIALS TRACE WIDTH MAY NEED TO BE MODIFIED.
- BOTTOM SIDE OF THE PCB IS CONTINUOUS GROUND PLANE.

- DENOTES PCB COPPER LAYOUT WITH SMOBC (SOLDER MASK OVER BARE COPPER)
- DENOTES COPPER LAND PATTERN FREE OF SOLDERMASK



SURFACE MOUNT

# RF Transformer

## SCTX2-93-2W+

Mini-Circuits

50Ω 10 to 9000 MHz 1:2 Ratio

### TYPICAL PERFORMANCE DATA

Frequency (MHz)	Insertion Loss (dB)	Input Return Loss (dB)	Amplitude Unbalance (dB)	Phase Unbalance (deg)
10	1.97	17.26	0.11	2.50
100	1.98	17.24	0.09	0.43
1000	1.91	19.81	-0.02	0.33
2000	1.80	28.27	-0.26	0.03
3000	2.27	13.27	-0.32	3.05
4000	2.65	13.73	0.29	4.56
5000	3.18	11.26	0.84	0.28
6000	3.30	8.87	0.26	6.47
7000	2.67	13.55	-0.85	4.67
8000	3.08	14.16	-1.06	1.57
9000	4.67	6.66	-0.44	9.01

SCTX2-93-2W+  
INSERTION LOSS

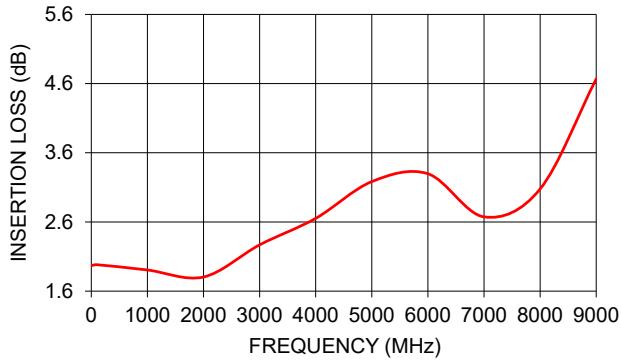

SCTX2-93-2W+  
INPUT RETURN LOSS

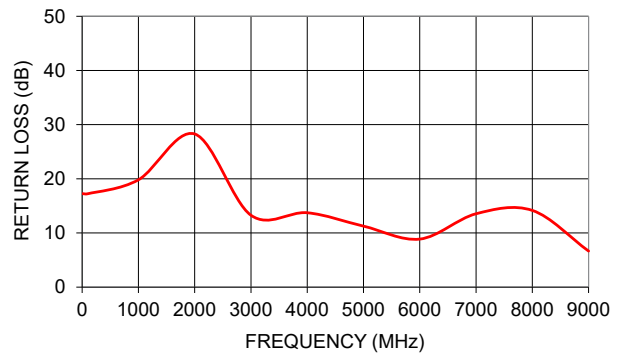

SCTX2-93-2W+  
AMPLITUDE UNBALANCE

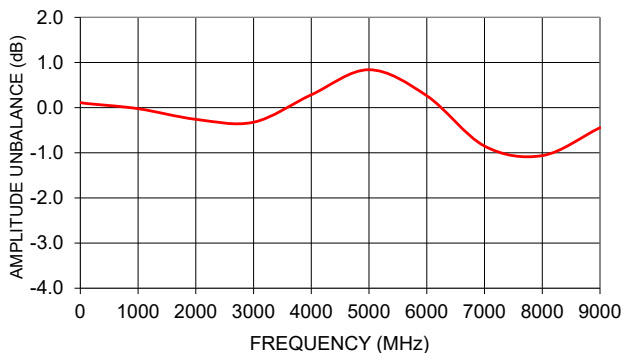

SCTX2-93-2W+  
PHASE UNBALANCE

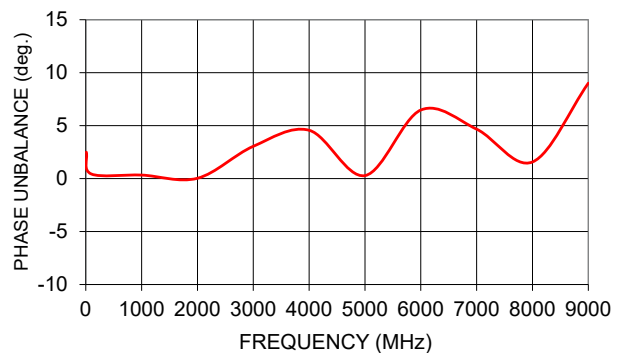

- NOTES**
- A. Performance and quality attributes and conditions not expressly stated in this specification document are intended to be excluded and do not form a part of this specification document.
  - B. Electrical specifications and performance data contained in this specification document are based on Mini-Circuit's applicable established test performance criteria and measurement instructions.
  - C. The parts covered by this specification document are subject to Mini-Circuits standard limited warranty and terms and conditions (collectively, "Standard Terms"); Purchasers of this part are entitled to the rights and benefits contained therein. For a full statement of the standard. Terms and the exclusive rights and remedies thereunder, please visit Mini-Circuits' website at [www.minicircuits.com/terms/viewterm.html](http://www.minicircuits.com/terms/viewterm.html)

