



LTCC SURFACE MOUNT

# Thru-Line

## TPCN-143+

50Ω DC to 14 GHz

### THE BIG DEAL

- Low Insertion Loss, 0.8 dB Typ.
- Return Loss, 10 dB Typ.
- 1206 Surface Mount Footprint
- Versatile "Place Holder" for Mini-Circuits LTCC Filters
- Power Handling: 9.75 W

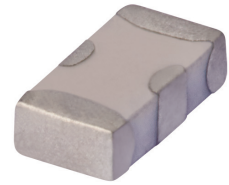

Generic photo used for illustration purposes only

### APPLICATIONS

- Test and Measurement Equipment
- Communication, EW, Radar and ECM Defense Systems
- 5G MIMO and Back Haul Radio Systems
- Satellite Communications

### FUNCTIONAL DIAGRAM



### PRODUCT OVERVIEW

TPCN-143+ is a miniature low temperature co-fired ceramic (LTCC) 50 Ohm transmission line, with low insertion loss through 14 GHz that supports a variety of applications. This model provides 0.8 dB typical insertion loss over a wide band due to its rugged monolithic construction. Housed in a tiny 1206 ceramic form factor with inspectable wrap-around terminations, the transmission line is ideal for dense signal chain PCB layouts, where it complements MMIC size and performance. The LTCC fabrication process assures minimal RF performance variation while delivering a product that is well suited for environmental extremes of high humidity and temperature.

### KEY FEATURES

Features	Advantages
Footprint Compatible "Thru-Line"	Enables system designers the flexibility to plan to add LTCC filters to the PCB layout at a later stage in the design process, after system test results are available. Compatible with Mini-Circuits high pass, low pass, and band pass filters (HFCN, LFCN & BFCN series) with identical case style and pad connections.
LTCC Construction	The use of LTCC technology allows for repeatable performance in a rugged ceramic package, well suited for tough environments such as high humidity and temperature extremes. See Mini-Circuits Environmental Rating ENV06T11 for more information.
Small Size, 1206	1206 package allows for space to be saved in dense circuit board layouts, while also minimizing the effects of parasitics.
Wrap-around Terminations	Provides excellent solderability and easy visual inspection.
Rugged Power Handling, 9.75 W	Handles up to 9.75 Watts in a small 1206 package.





### ELECTRICAL SPECIFICATIONS<sup>1,2</sup> AT +25°C

Parameter		F#	Frequency (GHz)	Min.	Typ.	Max.	Units
Passband	Insertion Loss	DC-F1	DC - 7	—	0.3	0.7	dB
		F1-F2	7 - 12	—	0.8	1.1	
		F2-F3	12 - 14	—	0.8	—	
	Return Loss	DC-F1	DC - 7	—	13	—	dB
		F1-F2	7 - 12	—	10	—	
		F2-F3	12 - 14	—	10	—	
Group Delay		DC-F3	DC - 14	—	70	—	psec

1. Tested on Evaluation Board P/N TB-TPCN-143+

2. Bi-directional RF1 and RF2 ports can be interchanged.

### ABSOLUTE MAXIMUM RATINGS<sup>3</sup>

Parameter	Ratings
Operating Temperature	-55°C to +125°C
Storage Temperature	-55°C to +125°C
Input Power <sup>4</sup>	9.75 W @ +25°C

3. Permanent damage may occur if any of these limits are exceeded.

4. Power rating applies only to signals within the passband. Power rating above +25°C operating temperature decreases linearly to 4 W at +125°C.

### TYPICAL FREQUENCY RESPONSE AT +25°C

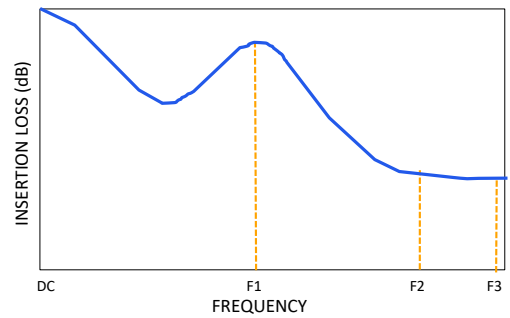



### TYPICAL PERFORMANCE GRAPHS

TPCN-143+  
INSERTION LOSS

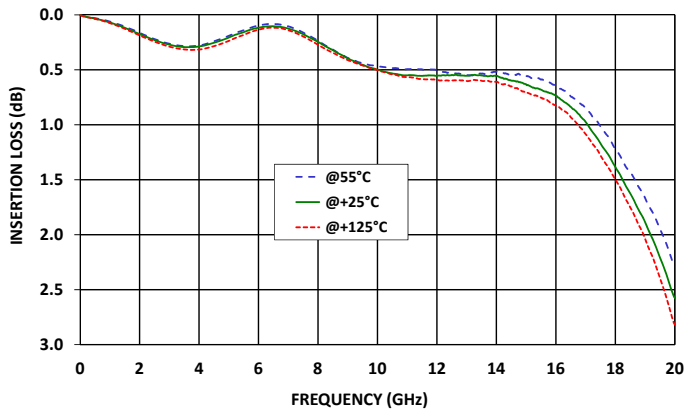

TPCN-143+  
RETURN LOSS

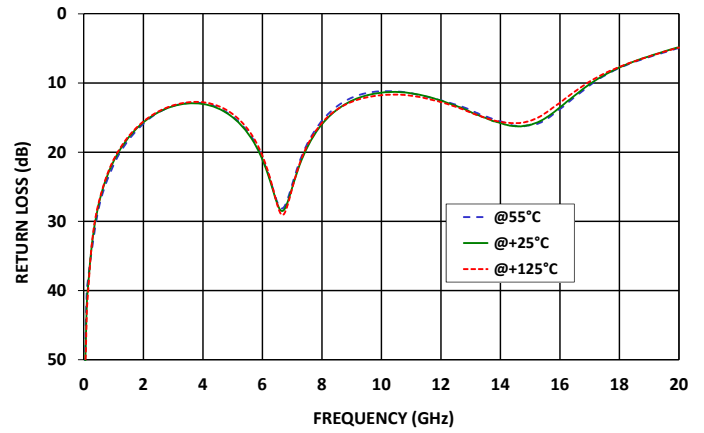

TPCN-143+  
GROUP DELAY

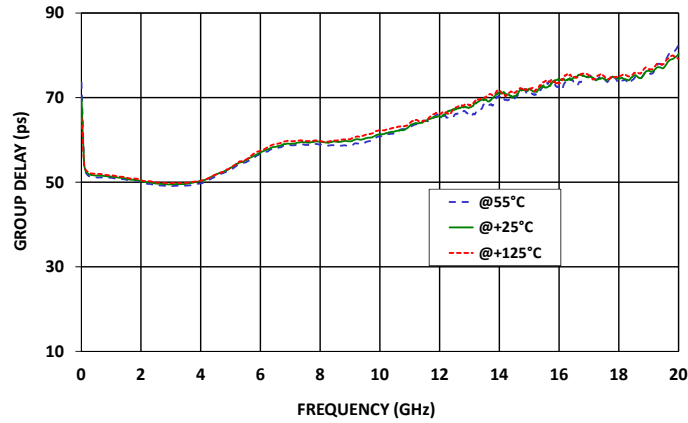



### FUNCTIONAL DIAGRAM

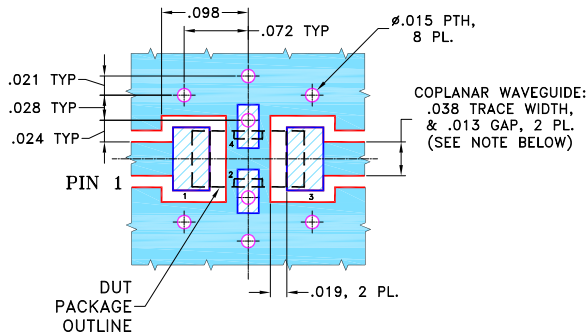

Figure 1. MODEL-TPCN-143+ Functional Diagram

### PAD DESCRIPTION

Function	Pad Number	Description
RF1 <sup>2</sup>	1	Connects to RF Input Port
RF2 <sup>2</sup>	3	Connects to RF Output Port
GROUND	2,4	Connects to Ground on PCB, (See drawing PL-137)

### SUGGESTED PCB LAYOUT (PL-137)



- NOTES:**
1. COPLANAR WAVEGUIDE PARAMETERS ARE SHOWN FOR ROGERS RO4350B WITH THICKNESS .020" ± .0015". COPPER: 1/2 OZ. EACH SIDE. FOR OTHER MATERIALS TRACE WIDTH & GAP MAY NEED TO BE MODIFIED.
  2. BOTTOM SIDE OF THE PCB IS CONTINUOUS GROUND PLANE.
- DENOTES PCB COPPER LAYOUT WITH SMOBC (SOLDER MASK OVER BARE COPPER)
  - DENOTES COPPER LAND PATTERN FREE OF SOLDER MASK

Figure 2. Suggested PCB Layout PL-137

### CASE STYLE DRAWING

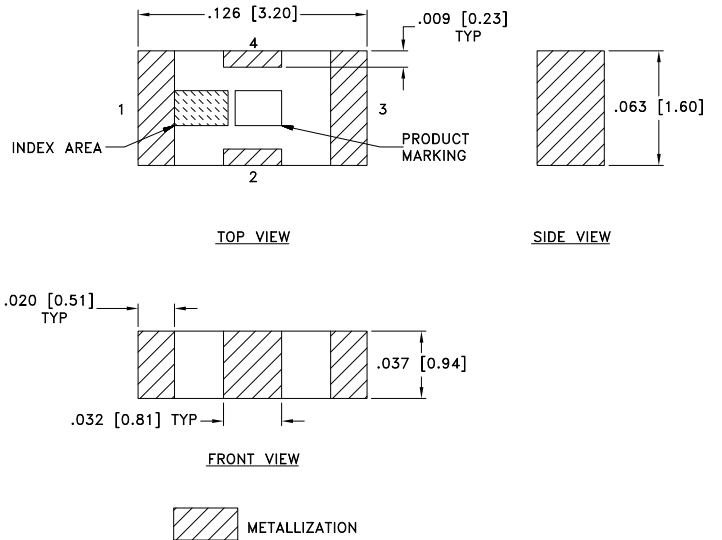

Weight: .020 grams.  
Dimensions are in inches (mm). Tolerances: 2 Pl.±.01; 3 Pl. ±.005

### PRODUCT MARKING\*: WP

\*Marking may contain other features or characters for internal lot control.



LTCC SURFACE MOUNT

# Thru-Line

## TPCN-143+

Mini-Circuits

50Ω DC to 14 GHz

ADDITIONAL DETAILED INFORMATION IS AVAILABLE ON OUR DASH BOARD. [CLICK HERE](#)

Performance Data and Graphs	Data
	Graphs
	S-Parameter (S2P Files) Data Set (.zip file) De-embedded to device pads
Case Style	FV1206 Lead Finish: Tin over Nickel Plating.
RoHS Status	Compliant
Tape and Reel	F71
Suggested Layout for PCB Design	PL-137
Evaluation Board	TB-TPCN-143+
	Gerber File
Environmental Rating	ENV06T11

### NOTES

- A. Performance and quality attributes and conditions not expressly stated in this specification document are intended to be excluded and do not form a part of this specification document.
- B. Electrical specifications and performance data contained in this specification document are based on Mini-Circuits' applicable established test performance criteria and measurement instructions.
- C. The parts covered by this specification document are subject to Mini-Circuits' standard limited warranty and terms and conditions (collectively, "Standard Terms"); Purchasers of this part are entitled to the rights and benefits contained therein. For a full statement of the standard terms and the exclusive rights and remedies thereunder, please visit Mini-Circuits' website at [www.minicircuits.com/terms/viewterm.html](http://www.minicircuits.com/terms/viewterm.html)

