



TTL

# Solid-State Switch

## TTL-1SP8T-183

Mini-Circuits

50Ω 0.1 to 18 GHz SP8T SMA female

### THE BIG DEAL

- Fast-switching, absorptive solid-state SP8T
- 100 ns switching time with no control delays
- TTL for simple control integration
- Low insertion loss

### APPLICATIONS

- RF signal routing / switch matrices
- 5G FR1, WiFi 6E, UWB, Bluetooth
- Military radio, radar & electronic warfare
- Microwave radio / cellular infrastructure
- Test & measurement systems



Generic photo used for illustration purposes only

### PRODUCT OVERVIEW

Mini-Circuits' TTL-1SP8T-183 is a fast switching SP8T featuring low loss and high isolation over a wide bandwidth. The switch has an absorptive configuration with internal terminations on ports J1 to J8.

Simple control via TTL logic levels allows integration with a wide range of microcontroller, embedded or custom systems, without the communication delays associated with USB or Ethernet control. This complete package enables exceptionally fast switching times down to 100 ns typically.

The switch is supplied in a low profile package (7.00" x 1.50" x 0.70") with 9 precision SMA (F) RF connectors and a D-Sub 9 pin port for power and control.

### KEY FEATURES

Feature	Advantages
Excellent RF performance	Low loss, high isolation and exceptional switching speeds support applications requiring rapid signal transitions and minimal interference such as semi-conductor and telecoms testing.
Solid-state design	Long-term reliability in the most demanding automated test applications
Optimized for hot switching	+30 dBm power rating applies even when hot switching or terminating inactive ports internally. Ideal for radio test applications where the signal can't be removed during switching.
TTL control	Simple control via TTL logic levels allows integration with a wide range of microcontroller, embedded or custom systems; and extremely fast switching times without the communication delays inherent to USB or Ethernet.

#### Trademarks:

Windows is a registered trademark of Microsoft Corporation in the United States and other countries; Linux is a registered trademark of Linus Torvalds; Pentium is a registered trademark of Intel Corporation. Neither Mini-Circuits nor the Mini-Circuits products are affiliated with or endorsed by the owners of the referenced trademarks. Mini-Circuits and the Mini-Circuits logo are registered trademarks of Scientific Components Corporation.



**TTL**

# Solid-State Switch

**TTL-1SP8T-183**

Mini-Circuits

50Ω 0.1 to 18 GHz SP8T SMA female

**ELECTRICAL SPECIFICATIONS AT -10 TO 60°C**

Parameter	Ports	Condition (GHz)	Min.	Typ.	Max.	Unit	
Frequency Range	-	-	0.1	-	18	GHz	
Insertion Loss	COM to any active port	0.1 - 0.5	-	2.0	3.0	dB	
		0.5 - 10	-	3.5	4.3		
		10 - 14	-	4.0	5.0		
		14 - 18	-	5.7	6.9		
Isolation	Between ports J1 to J8	0.1 - 0.5	60	80	-	dB	
		0.5 - 10	50	70	-		
		10 - 14	50	70	-		
		14 - 18	50	60	-		
	COM to any terminated port (including Disconnected state)	0.1 - 0.5	60	80	-	dB	
		0.5 - 10	53	70	-		
		10 - 14	53	65	-		
		14 - 18	50	60	-		
Return Loss	COM port (in all active states)	0.1 - 10	-	15	-	dB	
		10 - 18	-	13	-		
	Any port connected to COM	0.1 - 0.5	-	13	-	dB	
		0.5 - 10	-	14	-		
		10 - 14	-	15	-		
		14 - 18	-	13	-		
	Any terminated port	0.1 - 0.5	-	23	-	dB	
		0.5 - 10	-	16	-		
		10 - 14	-	12	-		
		14 - 18	-	10	-		
	Power Input @1 dB Compression	COM to any active port	0.1 - 4	-	+20	-	dBm
			4 - 18	-	+30	-	
IP3 <sup>1</sup>	COM to any active port	0.5 - 18	-	+40	-	dBm	
Transition Time <sup>2</sup>	-	-	-	50	-	ns	
Switching Time <sup>3</sup>	-	-	-	100	-	ns	
Operating RF Input Power	Between COM & active port	Hot switching	-	-	+30	dBm	
	Between COM & active port	Cold switching	-	-	+30		
	Into any termination	-	-	-	+30		

1. IP3 degrades below 500 MHz. Tested with 1 MHz span between signals, 0 dBm per tone

2. Transition Time spec represents the time that the RF signal paths are interrupted during switching (from steady state to steady state) and thus is specified without communication delays.

3. Switching time is the time from 50% control to 90 / 10% of RF signal.



TTL

# Solid-State Switch

## TTL-1SP8T-183

Mini-Circuits

50Ω 0.1 to 18 GHz SP8T SMA female

### DC ELECTRICAL SPECIFICATIONS

Parameter		Min.	Typ.	Max.	Units
Positive Supply	Voltage	4.75	5	5.25	V <sub>DC</sub>
	Current	-	170	200	mA
Negative Supply	Voltage	-5.25	-5	-4.75	V <sub>DC</sub>
	Current	-25	-20	-	mA
Control Current per bit		-	-	100	μA

### ABSOLUTE MAXIMUM RATINGS <sup>4</sup>

Operating Temperature	-10°C to 60°C
Storage Temperature	-20°C to 85°C
DC Supply Voltage @ positive supply (Pin#6)	0 to 6 V
DC Supply Voltage @ negative supply (Pin#6)	-5.3 to 0 V
Voltage at TTL control pins	5.5V
DC Voltage @ RF Ports	5.5V

4. Permanent damage may occur if any of these limits are exceeded. Operating in the range between operating power limits and absolute maximum ratings for extended periods of time may result in reduced life and reliability.



TTL

# Solid-State Switch

## TTL-1SP8T-183

Mini-Circuits

50Ω 0.1 to 18 GHz SP8T SMA female

### TYPICAL PERFORMANCE GRAPHS

#### Insertion Loss over Temperature (J1 Active)

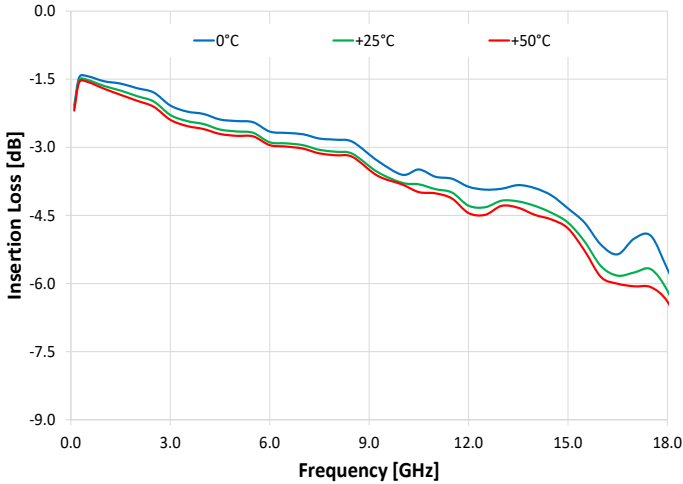

#### Insertion Loss J1 - J8 Active

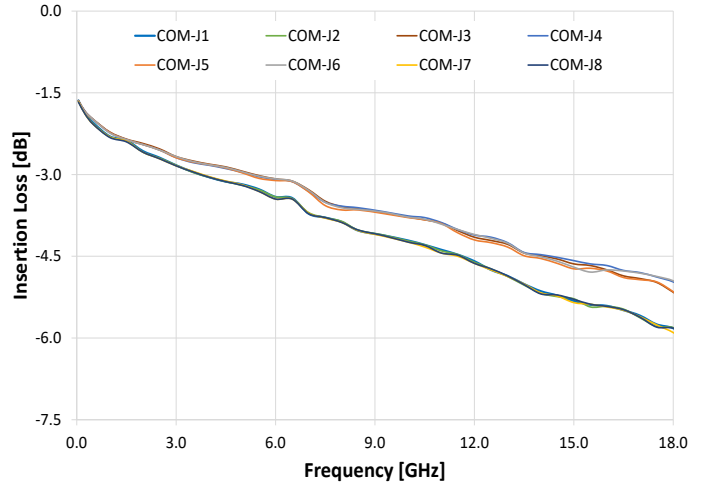

#### Isolation Com to J1 (J2 Active)

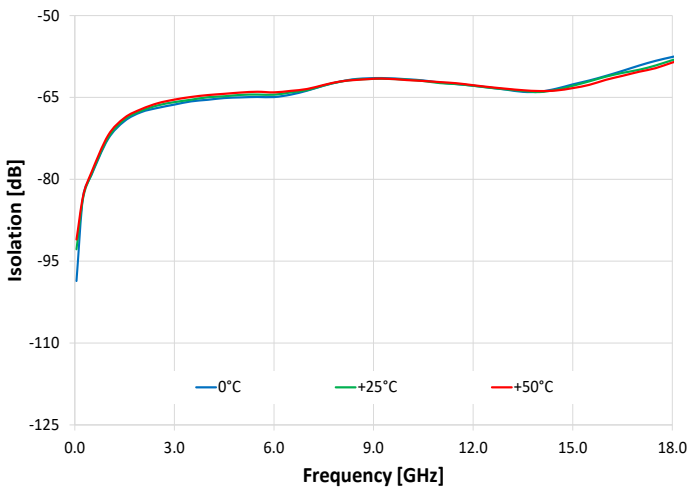

#### Isolation Com to J3 (J4 Active)

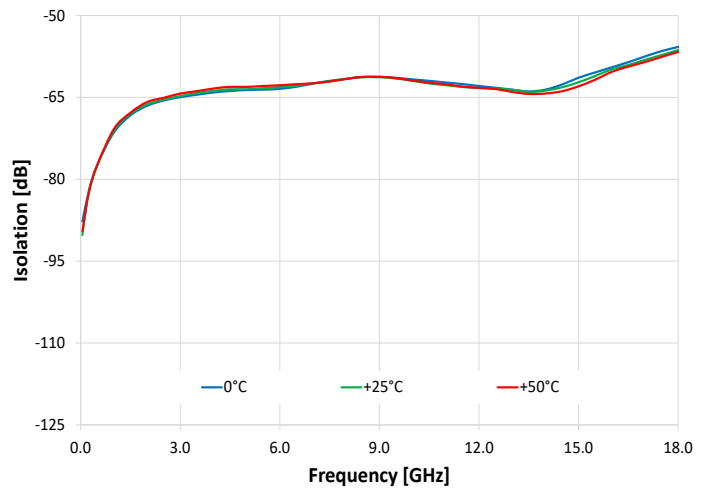

#### Isolation J2 to J3 (J2 Active)

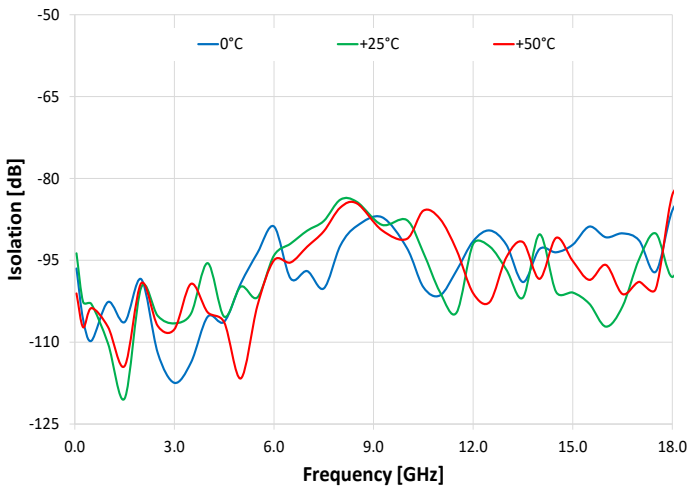

#### Isolation J7 to J8 (J7 Active)

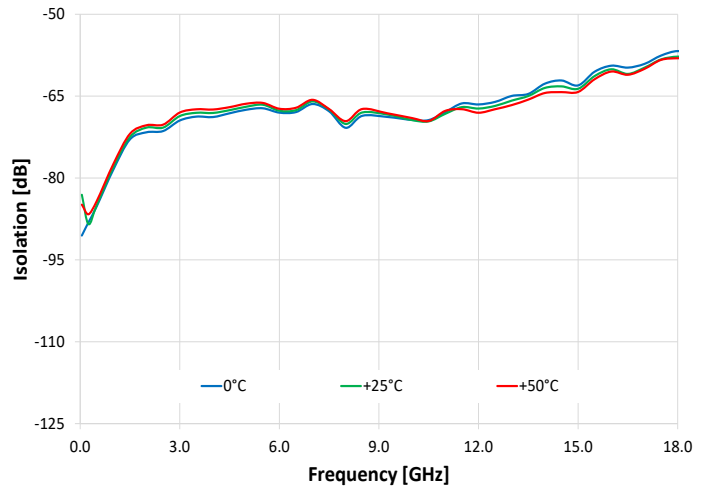



TTL

# Solid-State Switch

## TTL-1SP8T-183

Mini-Circuits

50Ω 0.1 to 18 GHz SP8T SMA female

### TYPICAL PERFORMANCE GRAPHS (CONTINUED)

Return Loss @ COM over Temperature (J1 Active)

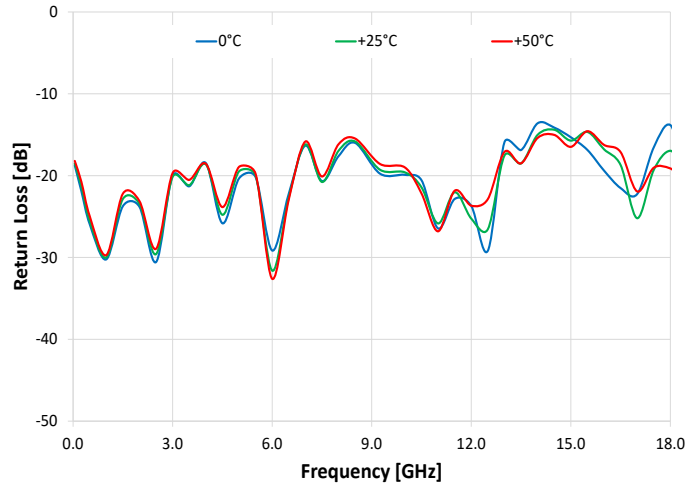

Return Loss @ J1 over Temperature (J1 Active)

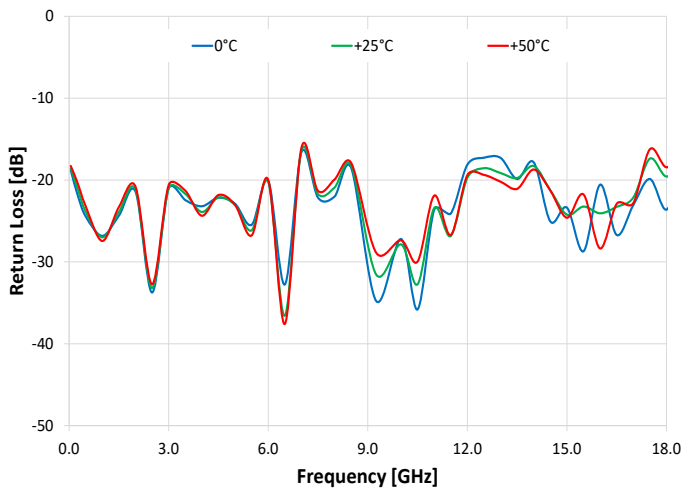

Return Loss @ J1 over Temperature (J1 Terminated)

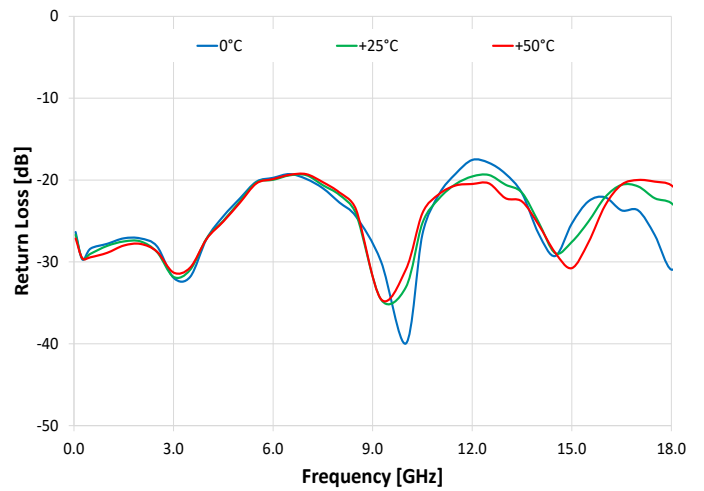

Return Loss @ Active ports (J1 - J8 Active)

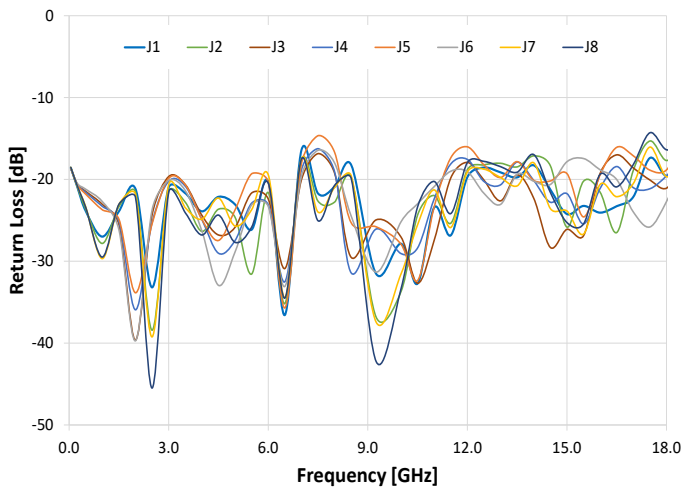

Return Loss @ Terminated ports (J1 - J8 Terminated)

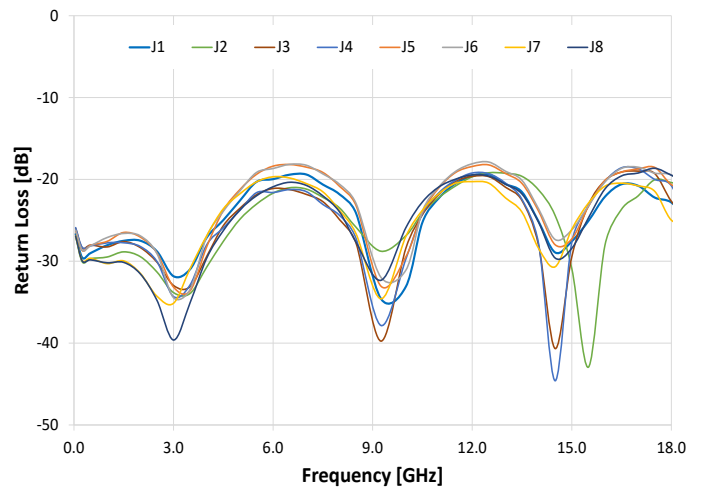



TTL

# Solid-State Switch

## TTL-1SP8T-183

Mini-Circuits

50Ω 0.1 to 18 GHz SP8T SMA female

### TTL CONTROL LOGIC

Parameter	Conditions		Min.	Typ.	Max.	Units
Voltage Levels	Logic Low Voltage	Input	0	-	0.8	V
	Logic High Voltage	Input	3.5	-	5.0	

The switch's TTL control interface consists of 4 parallel control bits that select the desired switch state, as shown in the truth table below. The parallel control does not have any latch and thus will respond immediately to any change.

The TTL inputs have internal 100kΩ pull-down (inputs D1, D2, & D3) and pull-up (input D4) resistors to set the switch to the disconnected state (all ports including COM internally terminated) when no control signal is applied.

The DC voltage supplies to the switch are provided via the D-sub port.

Switch State	Control Bits			
	D1	D2	D3	D4
Disconnected	Don't Care	Don't Care	Don't Care	Logic High
COM -> J8	Logic Low	Logic Low	Logic Low	Logic Low
COM -> J7	Logic High	Logic Low	Logic Low	Logic Low
COM -> J6	Logic Low	Logic High	Logic Low	Logic Low
COM -> J5	Logic High	Logic High	Logic Low	Logic Low
COM -> J4	Logic Low	Logic Low	Logic High	Logic Low
COM -> J3	Logic High	Logic Low	Logic High	Logic Low
COM -> J2	Logic Low	Logic High	Logic High	Logic Low
COM -> J1	Logic High	Logic High	Logic High	Logic Low

### D-SUB PIN CONNECTIONS

Pin	Function
1	D1
2	D2
3	D3
4	D4
5	Not connected
6	Supply +5V
7,9	GND
8	Supply -5V





TTL

# Solid-State Switch

## TTL-1SP8T-183

Mini-Circuits

50Ω 0.1 to 18 GHz SP8T SMA female

### BLOCK DIAGRAM

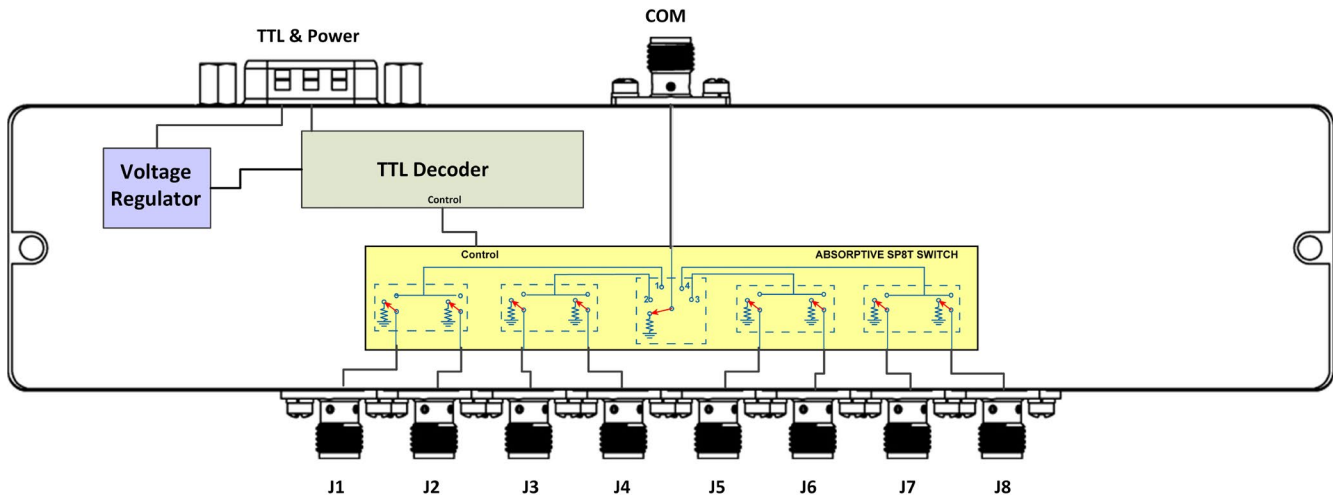

Switch functional diagram shown in disconnected state

### CONNECTIONS

Port Name	Connector Type
RF Ports (COM, J1 to J8)	SMA Female
TTL	9-pin D-Sub Male



TTL

# Solid-State Switch

## TTL-1SP8T-183

Mini-Circuits

50Ω 0.1 to 18 GHz SP8T SMA female

### CASE STYLE DRAWING (RB3408)

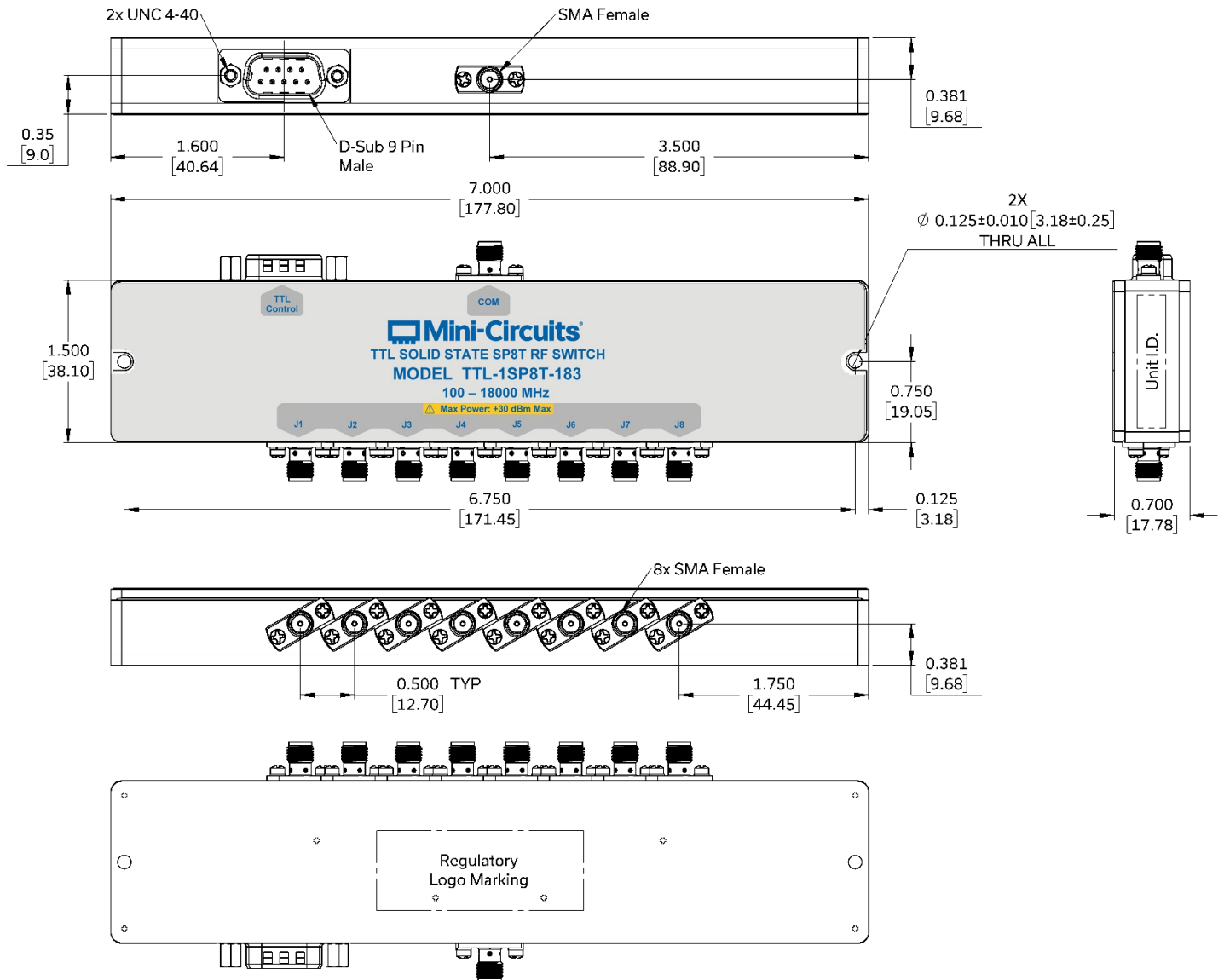

#### NOTES:

1. Case material: Aluminum alloy.
2. Case Finish: Nickel Plate.
3. Dimensions: Inches [mm].  
Tolerances 2 Pl.  $\pm 0.03$  inch; 3 Pl.  $\pm 0.015$  inch.
4. Weight: 400 grams
5. Marking may contain other features or characters for internal lot control.







TTL

# Solid-State Switch

**TTL-1SP8T-183**

Mini-Circuits

50Ω 0.1 to 18 GHz SP8T SMA female

## RECOMMENDED ACCESSORIES

TTL-1SP8T-183 is controlled via a standard 9 pin D-Sub connector and is supplied with a male-female D-Sub 9 cable. The cable is 6 feet (1.8 meter) long and uses 28 AWG wires.

### CONTROL CABLE D-SUB9-MF-6+

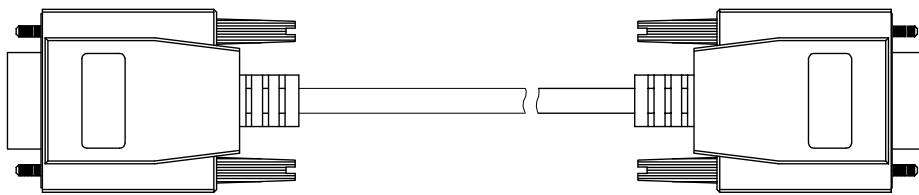

Pin Number (Male)	Function	Description	Pin Number (Female)
1	D1	Control bit 1	1
2	D2	Control bit 2	2
3	D3	Control bit 3	3
4	D4	Control bit 4	4
5	Not Connected	Not Connected	5
6	Supply +5V	Supply Voltage (Positive)	6
7	GND	Ground connection	7
8	Supply -5V	Supply Voltage (Negative)	8
9	GND	Ground connection	9



TTL

# Solid-State Switch

## TTL-1SP8T-183

Mini-Circuits

50Ω 0.1 to 18 GHz SP8T SMA female

DETAILED MODEL INFORMATION IS AVAILABLE ON OUR WEBSITE [CLICK HERE](#)

Performance Data & Graphs	Data Graphs
Case Style	RB3408
Environmental Rating	ENV55T2
User Guide	<a href="https://www.minicircuits.com/softwaredownload/solidstate.html">https://www.minicircuits.com/softwaredownload/solidstate.html</a>
Regulatory Compliance	<p>Refer to user guide for compliance information</p>  <p><a href="https://www.minicircuits.com/app/AN49-012.pdf">https://www.minicircuits.com/app/AN49-012.pdf</a></p>
Support	<a href="mailto:testsolutions@minicircuits.com">testsolutions@minicircuits.com</a>

### INCLUDED ACCESSORIES

	Part No.	Description
See drawing on page 9	D-SUB9-MF-6+	6.0 ft (1.8 m) D-Sub cable: 9 pin D-sub (Male) to 9 pin D-sub (Female)

**NOTES:**

- A. Performance and quality attributes and conditions not expressly stated in this specification document are intended to be excluded and do not form a part of this specification document.
- B. Electrical specifications and performance data contained in this specification document are based on Mini-Circuit's applicable established test performance criteria and measurement instructions.
- C. The parts covered by this specification document are subject to Mini-Circuits standard limited warranty and terms and conditions (collectively, "Standard Terms"); Purchasers of this part are entitled to the rights and benefits contained therein. For a full statement of the Standard Terms and the exclusive rights and remedies thereunder, please visit Mini-Circuits' website at <https://www.minicircuits.com/terms/viewterm.html>

