



MMIC REFLECTIONLESS

Band Pass Filter

XBF-282+

50Ω 2350 to 3150 MHz

THE BIG DEAL

- Match to 50Ω in the stop band, eliminates undesired reflections
- Cascadable
- Excellent Power handling
- Temperature stable, up to 105°C
- Small size, 3 x 3 mm
- Protected by US Patent No. 8,392,495

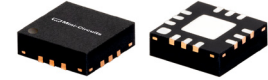

Generic photo used for illustration purposes only

CASE STYLE: DQ1225

+RoHS Compliant

The +Suffix identifies RoHS Compliance. See our website for methodologies and qualifications

APPLICATIONS

- Wi-Fi
- WiMax
- Bluetooth
- Satellite

GENERAL DESCRIPTION

Mini-Circuits' XBF-282+ reflectionless filter employs a novel filter topology which absorbs and terminates stop band signals internally rather than reflecting them back to the source. This new capability enables unique applications for filter circuits beyond those suited to traditional approaches. Traditional filters are reflective in the stop band, sending signals back to the source at 100% of the power level. These reflections interact with neighboring components and often result in inter-modulation and other interferences. Reflectionless filters eliminate stop band reflections, allowing them to be paired with sensitive devices and used in applications that otherwise require circuits such as isolation amplifiers or attenuators.

KEY FEATURES

Features	Advantages
Easy integration with sensitive reflective components, e.g. mixers, multipliers	Reflectionless filters absorb unwanted signals, preventing reflections back to the source. This reduces generation of additional unwanted signals without the need for extra components like attenuators, improving system dynamic range and saving board space.
Enables stable integration of wideband amplifiers	Because reflectionless filters maintain good impedance in the stop band; they can be integrated with high gain, wideband amplifiers without the risk of creating instabilities in these out of band regions.
Cascadable	Reflectionless filters can be cascaded in multiple sections to provide sharper and higher attenuation, while also preventing any standing waves that could affect pass band signals.
Excellent power handling in a tiny surface mount	High power handling extends the usability of these filters to the transmit path for inter-stage filtering.
Small size, 3x3mm QFN	Allows replacement of filter/attenuator pairs with a single reflectionless filter, saving board space. Tiny footprint saves space in dense layouts while providing low inductance, repeatable transitions, and excellent thermal contact to the PCB.
Excellent repeatability of RF performance	Through semiconductor IPD process, X-series filters are inherently repeatable for large volume production.
Operating temperature up to 105 °C	Suitable for operation close to high power components.

*IPD - Integrated Passive Device, is a GaAs semiconductor process



ELECTRICAL SPECIFICATIONS¹ AT +25°C

Parameter	F#	Frequency (MHz)	Min.	Typ.	Max.	Unit	
Pass Band	Insertion Loss	F2-F3	2350 - 3150	—	3.2	3.6	dB
	VSWR	F2-F3	2350 - 3150	—	1.2	—	:1
Stop Band, Lower	Rejection	DC-F1	DC - 1810	12	15	—	dB
	VSWR	DC-F1	DC - 1810	—	1.2	—	:1
Stop Band, Upper	Rejection	F4-F5	3800 - 9500	12	15	—	dB
		F5-F6	9500 - 20000	—	20	—	
	VSWR	F4-F5	3800 - 9500	—	1.2	—	:1
		F5-F6	9500 - 20000	—	1.5	—	

1. Measured on Mini-Circuits Characterization Test Board TB-968-163+

ABSOLUTE MAXIMUM RATINGS²

Parameter	Ratings
Operating Temperature	-55°C to +105°C
Storage Temperature	-65°C to +150°C
RF Power Input, Passband (F2-F3) ³	2W at 25°C
RF Power Input, Stopband (DC-F2, F3-F6) ⁴	0.5W at 25°C

2. Permanent damage may occur if any of these limits are exceeded.

3. Passband rating derates linearly to 0.25W at 105°C ambient

4. Stopband rating derates linearly to 0.08W at 105°C ambient

SPECIFICATION DEFINITION

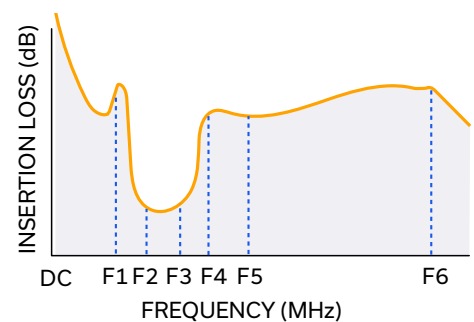



MMIC REFLECTIONLESS

Band Pass Filter

XBF-282+

Mini-Circuits

50Ω 2350 to 3150 MHz

SIMPLIFIED SCHEMATIC AND PAD DESCRIPTION

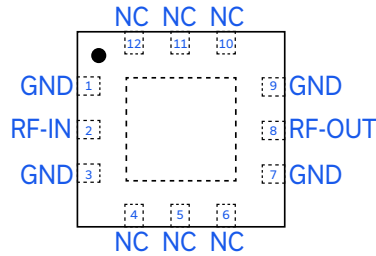
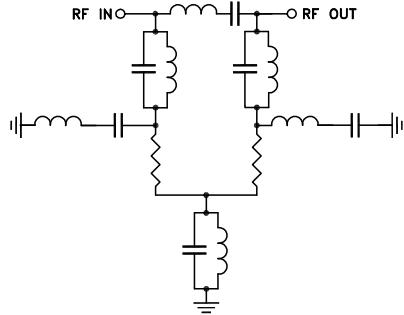

Function	Pad Number	Description
RF-IN	2	RF Input Pad
RF-OUT	8	RF Output Pad
GND	1,3,7,9, Paddle	Connected to ground
NC (GND Externally)	4,5,6,10,11,12	No internal connection

PRODUCT MARKING

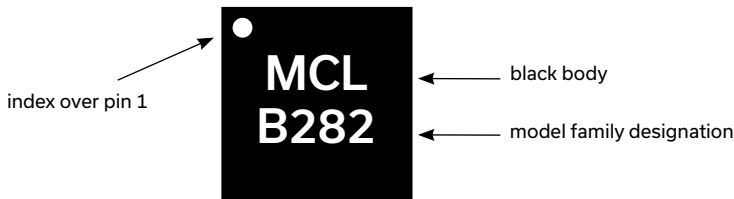

Marking may contain other features or characters for internal lot control





MMIC REFLECTIONLESS

Band Pass Filter

XBF-282+

Mini-Circuits

50Ω 2350 to 3150 MHz

TYPICAL PERFORMANCE DATA AT +25°C

Frequency (MHz)	Insertion Loss (dB)	VSWR (:1)
10	44.12	1.04
50	39.26	1.04
100	35.00	1.05
200	29.51	1.07
400	23.66	1.11
1000	16.34	1.26
1810	16.16	1.23
2350	2.50	1.20
3150	3.10	1.04
3800	15.35	1.25
5000	15.22	1.19
6500	17.66	1.10
8000	19.49	1.10
9500	17.03	1.34
11000	20.26	1.29
13000	22.61	1.37
15000	20.73	1.40
17000	18.99	1.28
19000	18.32	1.82
20000	18.66	2.59

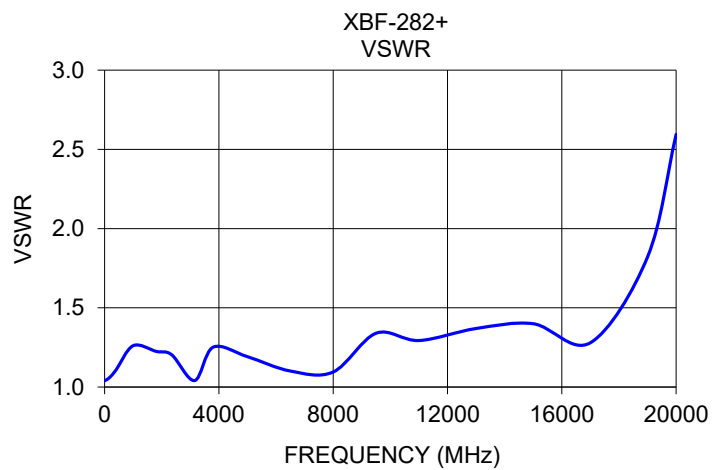
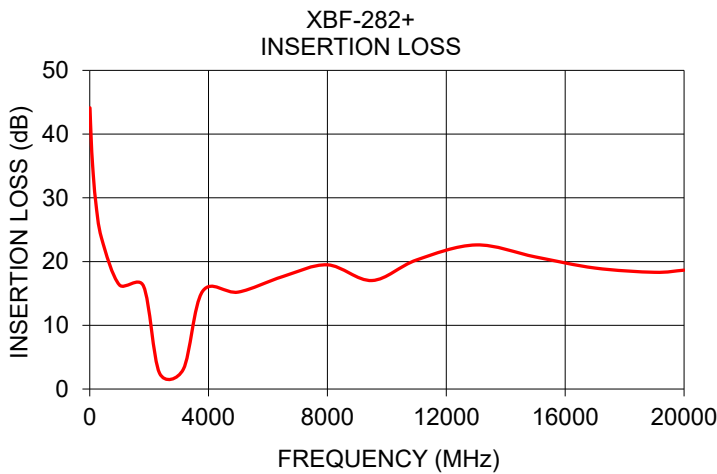



ADDITIONAL DETAILED TECHNICAL INFORMATION IS AVAILABLE ON OUR DASH BOARD. TO ACCESS [CLICK HERE](#)

Performance Data and Graphs	Data Graphs S-Parameter (S3P Files) Data Set (.zip file)
Case Style	DQ1225 Plastic package, exposed paddle lead finish: matte-tin
Tape & Reel Standard quantities available on reel	F66 7" reels with 20, 50, 100, 200, 500, 1000, 2000 or 3000 devices
Suggested Layout for PCB Design	PL-451
Evaluation Board	TB-844-282B+ (without connectors) TB-844-282BC+ (with connectors) B20-118-F1+ Connector sold separately
Environmental Ratings	ENV82

ESD RATING

Human Body Model (HBM): Class 2 (2000 to <4000 V) in accordance with ANSI/ESD STM 5.1 - 2001

MSL TEST FLOW CHART

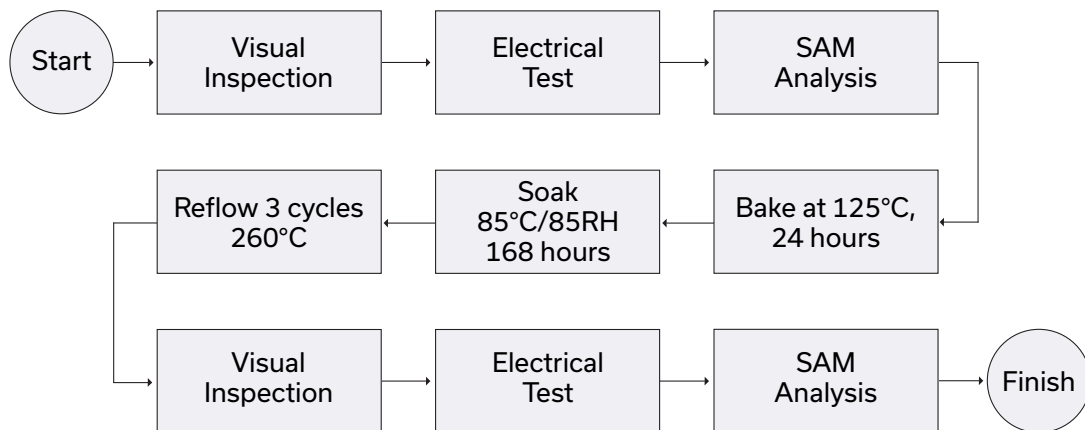



REFLECTIONLESS FILTER APPLICATION NOTE

Application Circuit Example: Pairing mixers with reflectionless filters to improve system dynamic range

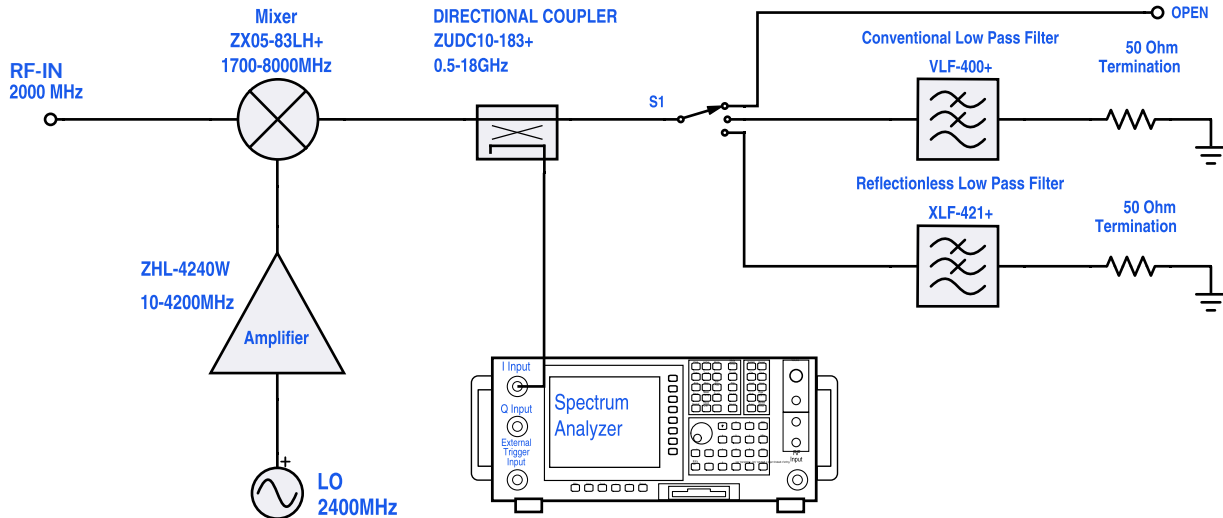

Test block diagram: IF output reflection spectrum with single input frequency

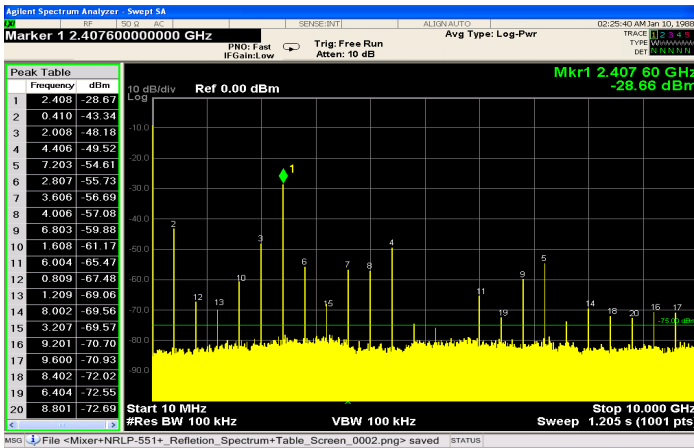

Figure 1. IF output reflection spectrum without filter

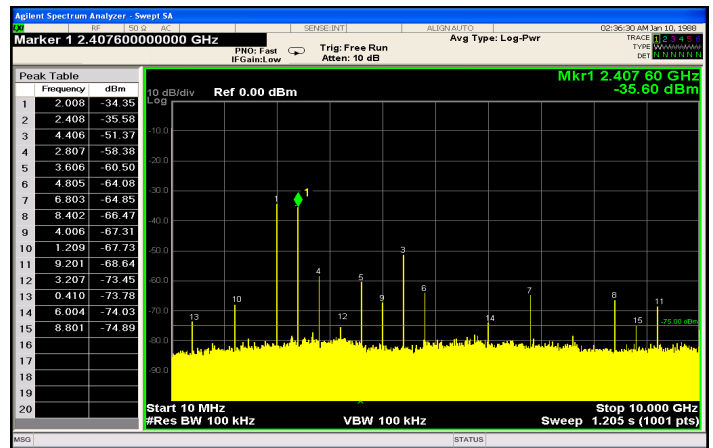

Figure 2. IF output reflection spectrum with conventional filter

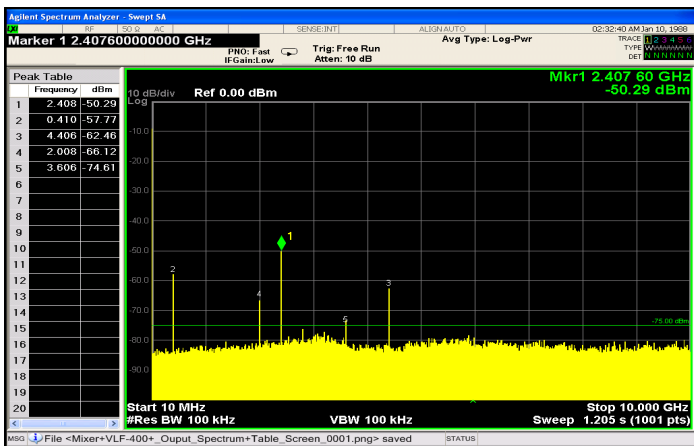

Figure 3. IF output reflection spectrum with reflectionless filter

An application circuit was assembled to measure the IF reflection spectrum at the output of a mixer when the mixer was paired with a conventional filter versus a reflectionless filter. While the conventional filter reduces the reflections present when the mixer is used alone (no filter), the reflectionless filter virtually eliminates those reflections altogether. The reflected signal at marker 1 in the figures above exhibits a reduction of more than 20 dB from -28.7 dBm to -50.3 dBm when the reflectionless filter is used as compared to the conventional filter, thus eliminating unwanted spurious mixing products and improving system dynamic range. For more information, refer to application note [AN-75-007](#)

NOTES

- A. Performance and quality attributes and conditions not expressly stated in this specification document are intended to be excluded and do not form a part of this specification document.
- B. Electrical specifications and performance data contained in this specification document are based on Mini-Circuit's applicable established test performance criteria and measurement instructions.
- C. The parts covered by this specification document are subject to Mini-Circuits standard limited warranty and terms and conditions (collectively, "Standard Terms"); Purchasers of this part are entitled to the rights and benefits contained therein. For a full statement of the standard terms and the exclusive rights and remedies thereunder, please visit Mini-Circuits' website at www.minicircuits.com/terms/viewterm.html