



MMIC SURFACE MOUNT

Low Pass Filter

XLF-222H+

50Ω DC to 2200 MHz Reflectionless

THE BIG DEAL

- Reflectionless Technology, Eliminates Reflections with 50Ω Match in Stopband
- Temperature Robust, up to +105°C Operation
- Compact Size, 4x4 mm 24-Lead QFN-Style Package
- Excellent Performance Repeatability

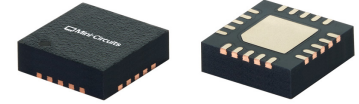

Generic photo used for illustration purposes only

PATENTS

- Protected by US Patent Nos. 10,516,378, 10,374,577, 10,263,592, 10,230,348, 9,705,467, and 8,392,495
- Protected by China Patent Nos. 107078708B, and 102365784B
- Protected by Taiwan Patent Nos. 653826B, and 581494B

APPLICATIONS

- Test and Measurement Equipment
- Radar Systems
- SatCom Systems
- Harmonic Suppression

FUNCTIONAL DIAGRAM

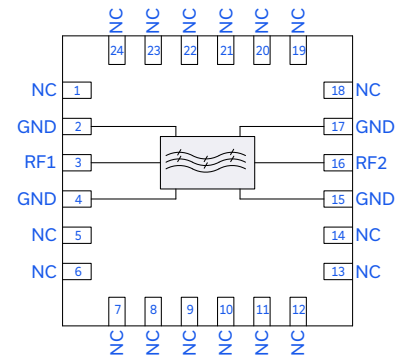

PRODUCT OVERVIEW

Mini-Circuits' XLF-222H+ reflectionless filter employs a novel filter topology which absorbs and terminates stopband signals internally rather than reflecting them back to the source. This new capability enables unique applications for filter circuits beyond those suited to traditional approaches. Traditional filters are reflective in the stopband, sending signals back to the source at 100% of the power level. These reflections interact with neighboring components and often result in intermodulation products and other interferences. Reflectionless filters eliminate stopband reflections, allowing them to be paired with sensitive devices and used in applications that otherwise require circuits such as isolation amplifiers or attenuators.

KEY FEATURES

Features	Advantages
Reflectionless Technology	Reflectionless filters absorb unwanted signals, preventing reflections back to the source. This reduces generation of additional unwanted signals without the need for extra components like attenuators, improving system dynamic range and saving board space.
50Ω Match in Stopband	Reflectionless filters maintain good impedance matching in the stopband, allowing for integration with high gain, wideband amplifiers without the risk of creating out of band instabilities.
Excellent RF Performance Repeatability	Fabricated on a GaAs process, X-series filters are inherently repeatable for large volume production.
Excellent Temperature Stability and Robustness	With ±0.3 dB variation over temperature, the XLF-222H+ is ideal for use in wide temperature range applications without the need for additional temperature compensation. Up to +105°C rating allows for suitable operation close to high power components.
Excellent Power Handling in a Compact Package <ul style="list-style-type: none"> • Passband +37 dBm at +25°C • Stopband +29 dBm at +25°C 	High power handling extends the usability of these filters to the transmit path for inter-stage filtering. A compact, 4x4 mm 24-Lead QFN-style package enables replacement of filter/ attenuator pairs with a single reflectionless filter, saving board space in dense assemblies.





ELECTRICAL SPECIFICATIONS^{1,2,3} AT +25°C

Parameter		F#	Frequency (GHz)	Min.	Typ.	Max.	Units
Passband	Insertion Loss	DC-F1	DC-2.2		1.5	2.9	dB
	Frequency Cut-Off	F2	2.4		3.0		dB
	Return Loss	DC-F1	DC-2.2		20.0		dB
Stopband	Rejection	F3-F4	4-6	34	43		dB
		F4-F5	6-10		52		
		F5-F6	10-20		42		
	Return Loss	F3-F4	4-6		15.9		dB
		F4-F5	6-10		15.0		
		F5-F6	10-20		8.0		

1. Tested on Mini-Circuits Characterization Test Board TB-XLF-222HC+. See Figure 2. De-embedded to the device reference plane.
2. Bi-directional RF1 and RF2 ports can be interchanged. See S-Parameters for actual performance.
3. All electrical specifications measured at RF Input Power = -10 dBm.

TYPICAL FREQUENCY RESPONSE AT +25°C

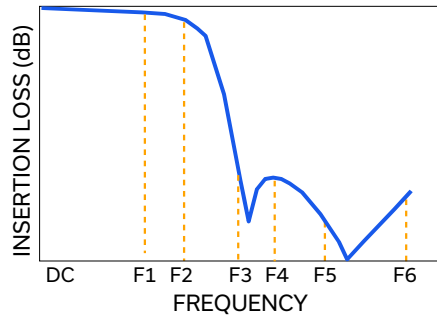



TYPICAL PERFORMANCE GRAPHS

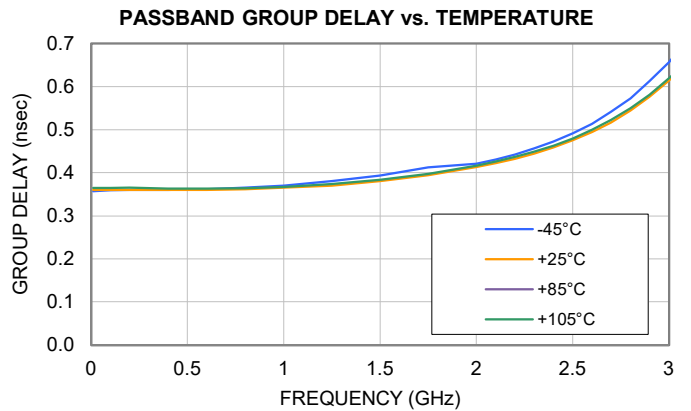
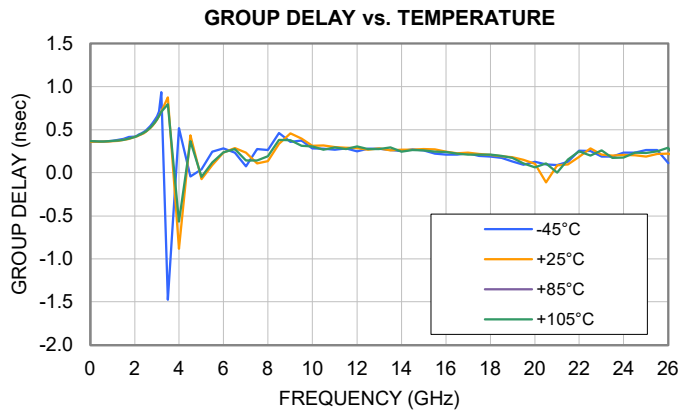
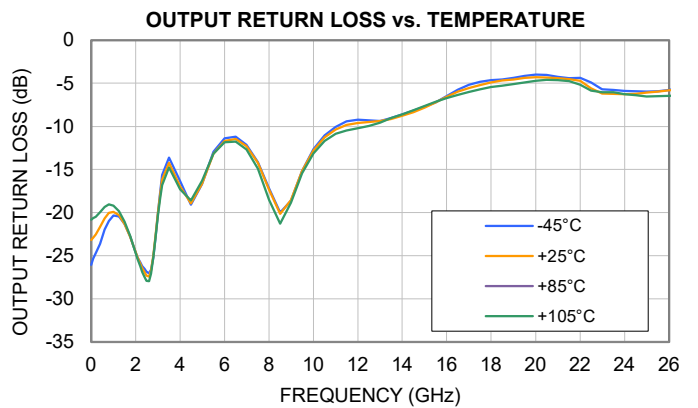
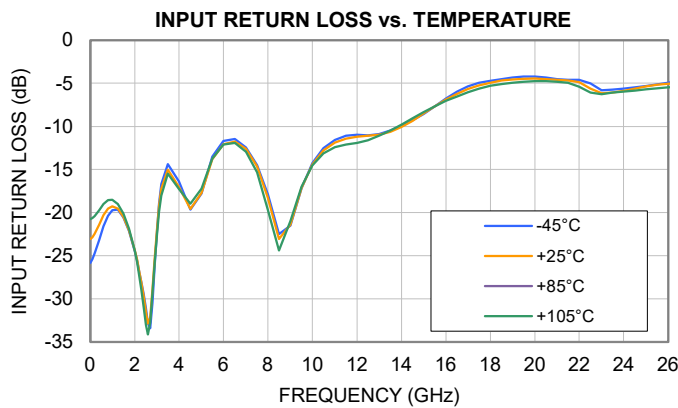
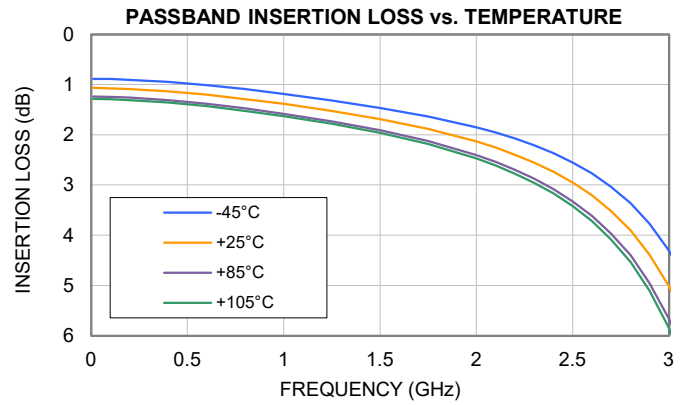
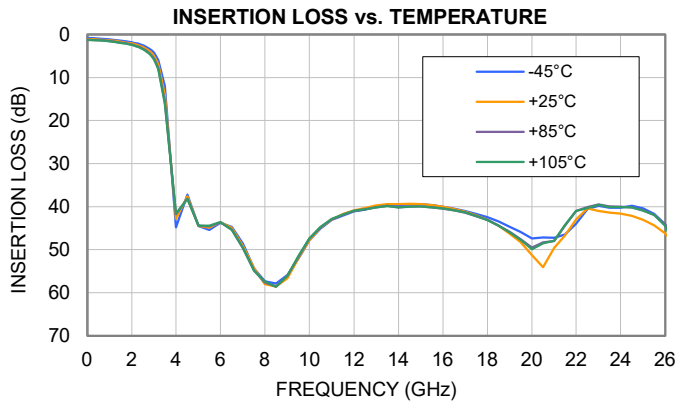

**ABSOLUTE MAXIMUM RATINGS⁴**

Parameter	Ratings
Operating Temperature	-45°C to +105°C
Storage Temperature	-65°C to +150°C
Input Power, Passband (DC to F2) ⁵	+37 dBm
Input Power, Stopband (F3 to F6) ⁶	+29 dBm

4. Permanent damage may occur if any of these limits are exceeded. These ratings are not intended for continuous normal operation.

5. Power rating above +25°C operating temperature decreases linearly to +34 dBm at +105°C.

6. Power rating above +25°C operating temperature decreases linearly to +26 dBm at +105°C.

THERMAL RESISTANCE

Parameter	Ratings
Thermal Resistance (Θ_{jc}) ^{7,8}	6.7°C/W

7. Θ_{jc} = (Hot Spot Temperature on Die - Temperature at Ground Lead)/Dissipated Power

8. Measured at 1 GHz with RF Input Power equal to 1 W.

ESD RATING

	Class	Voltage Range	Reference Standard
HBM	1B	500 V to < 1000 V	ANSI/ESDA/JEDEC JS-001-2017
CDM	C1	250 V to < 500 V	JESD22-C101F



ESD HANDLING PRECAUTION: This device is designed to be Class 1B for HBM. Static charges may easily produce potentials higher than this with improper handling and can discharge into DUT and damage it. As a preventive measure Industry standard ESD handling precautions should be used at all times to protect the device from ESD damage.

MSL RATING

Moisture Sensitivity: MSL1 in accordance with IPC/JEDEC J-STD-020E/JEDEC J-STD-033C



FUNCTIONAL DIAGRAM

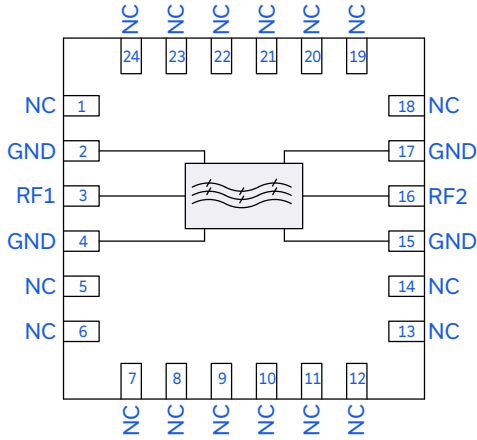

Figure 1. XLF-222H+ Functional Diagram

PAD DESCRIPTION

Function	Pad Number	Description (Refer to Figure 2)
RF1	3	RF1 Pad connects to RF-Input port.
RF2	16	RF2 Pad connects to RF-Output port.
GND	2, 4, 15, 17, and Paddle	Connects to Ground.
NC	1, 5-14, 18-24	Not used internally.

CHARACTERIZATION TEST BOARD

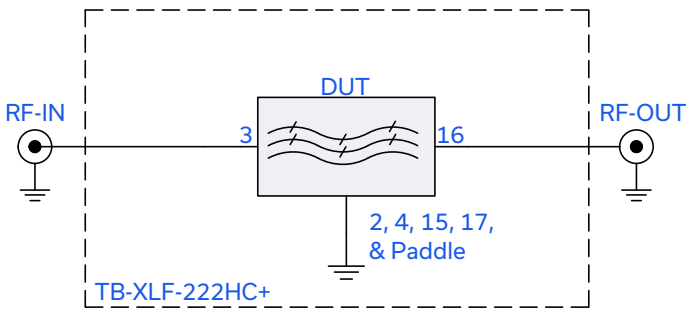

Figure 2. DUT soldered on Mini-Circuits Characterization Test Board TB-XLF-222HC+

Electrical Parameters and Conditions

Passband Insertion Loss, Stopband Rejection, and Return Loss measured using N5242A PNA-X Microwave Network Analyzer.

Conditions:

1. RF Input Power = -10 dBm
2. XLF-222H+ is bi-directional. RF1 and RF2 are interchangeable.



CASE STYLE DRAWING

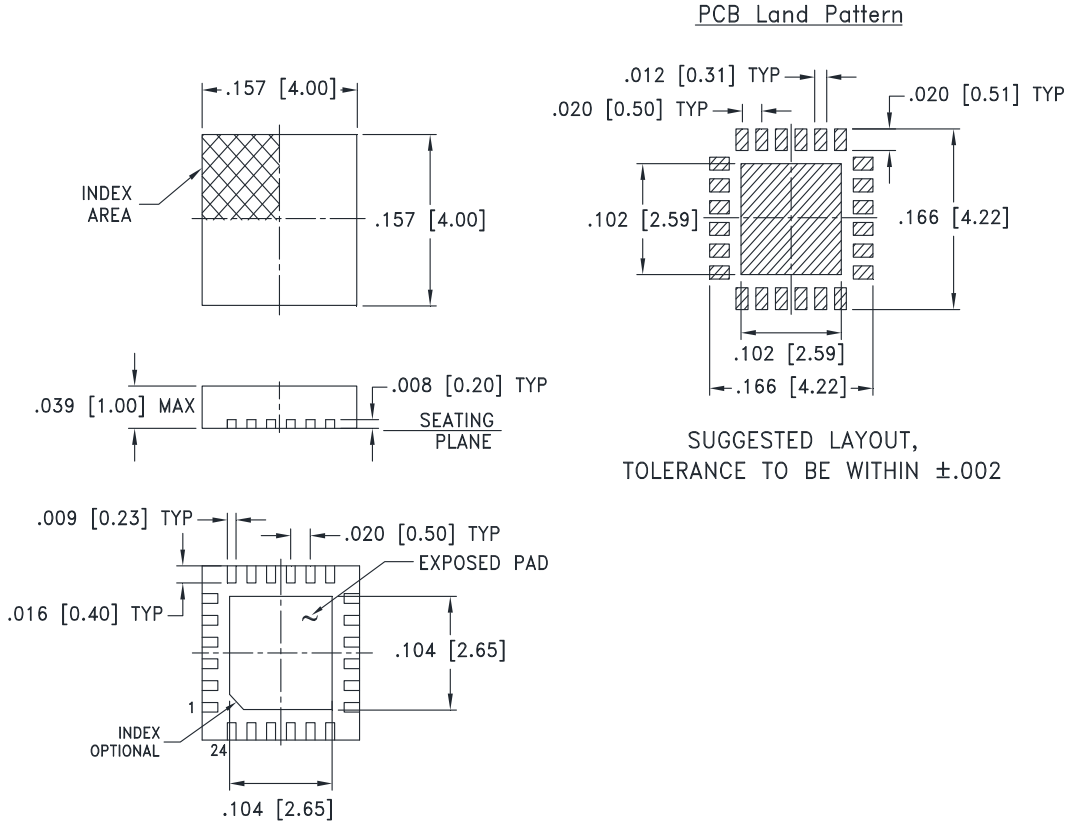

PCB Land Pattern

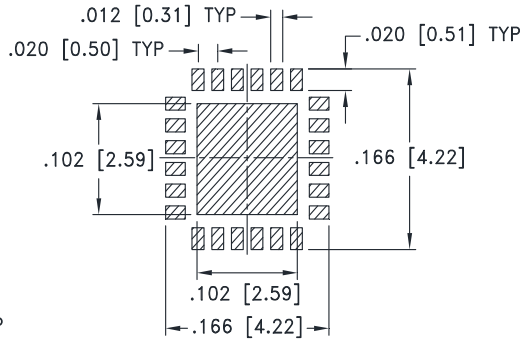

SUGGESTED LAYOUT,
TOLERANCE TO BE WITHIN ±.002

Weight: .04 Grams

Dimensions are in inches [mm]. Tolerances in inches: 2 Pl. ± .01; 3 Pl. ± .005 inches

PRODUCT MARKING

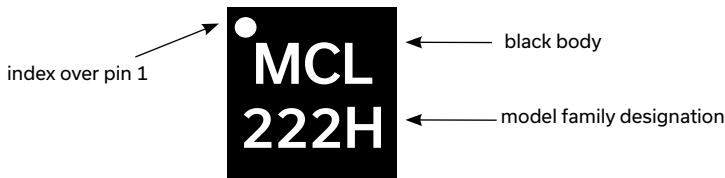

Marking may contain other features or characters for internal lot control



MMIC SURFACE MOUNT

Low Pass Filter

XLF-222H+

50Ω DC to 2200 MHz Reflectionless

ADDITIONAL DETAILED INFORMATION IS AVAILABLE ON OUR DASH BOARD

[CLICK HERE](#)

Performance Data & Graphs	Data Graphs S-Parameter (S2P Files) Data Set (.zip file)
Case Style	DG1847. Plastic package, exposed paddle, Lead Finish: Matte-Tin
RoHS Status	Compliant
Tape & Reel Standard quantities available on reel	F68 7" reels with 20, 50, 100, 200, 500 or 1K devices
Suggested Layout for PCB Design	PL-765
Evaluation Board	TB-XLF-222HC+ Gerber File
Environmental Ratings	ENV82

NOTES

- A. Performance and quality attributes and conditions not expressly stated in this specification document are intended to be excluded and do not form a part of this specification document.
- B. Electrical specifications and performance data contained in this specification document are based on Mini-Circuit's applicable established test performance criteria and measurement instructions.
- C. The parts covered by this specification document are subject to Mini-Circuits standard limited warranty and terms and conditions (collectively, "Standard Terms"); Purchasers of this part are entitled to the rights and benefits contained therein. For a full statement of the standard terms and the exclusive rights and remedies thereunder, please visit Mini-Circuits' website at www.minicircuits.com/terms/viewterm.html

