



(LTCC) COAXIAL

High Pass Filter

ZHFW-K5500+

50Ω 6.1 to 20 GHz 2.92mm Female

KEY FEATURES

- Low Insertion Loss, 1.2 dB Typ.
- Return Loss, 12 dB Typ.
- Stop Band Rejection, 45 dB Typ.
- Broadband Connectorized Package.
- Power Handling: 1.75 Watts.

APPLICATIONS

- Test and Measurement Equipment.
- Military Applications.
- Telecommunications and Broadband Wireless Systems.



Generic photo used for illustration purposes only

PRODUCT OVERVIEW

ZHFW-K5500+ is a 50ohm high pass filter built in broad band connectorized package. Covering 6100-20000 MHz bandwidth, these units offer good matching within the passband and good rejection in stopband. ZHFW-K5500+ offer low insertion loss, and excellent power handling capability. It handles up to 1.75W RF input power and provides a wide operating temperature range from -55°C to 125°C.

FUNCTIONAL DIAGRAM

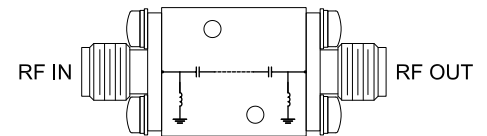

ELECTRICAL SPECIFICATIONS^{1,2} AT +25°C

Parameter		F#	Frequency (MHz)	Min.	Typ.	Max.	Units
Pass Band	Insertion Loss	F3-F4	6100 - 7400	—	2.6	—	dB
		F4-F5	7400 - 13500	—	1.2	2.2	
		F5-F6	13500 - 20000	—	1.6	—	
Pass Band	Return Loss	F3-F4	6100 - 7400	—	12	—	dB
		F4-F5	7400 - 13500	—	15	—	
		F5-F6	13500 - 20000	—	12	—	
Stop Band	Rejection	DC-F1	DC - 3300	40	44	—	dB
		F1-F2	3300 - 4400	25	45	—	
	Freq. Cut-Off ³	Fc ³	5500	—	3	—	dB

1. This filter is bi-directional, RF1 and RF2 ports may be interchanged, see S-Parameters for actual performance.

2. This component should not be used as a DC-block. In applications where DC voltage and/or current is present at either the input or output ports, external DC blocking capacitors are required.

3. Typical variation ± 5%

ABSOLUTE MAXIMUM RATINGS⁴

Parameter	Ratings
Operating Temperature	-55 °C to +125 °C
Storage Temperature	-55 °C to +125 °C
Input Power ⁵	1.75 W @25°C

4. Permanent damage may occur if any of these limits are exceeded.

5. Power rating applies only to signals within the passband. Power rating above +25°C operating temperature decreases linearly to 0.5W at +125°C.

TYPICAL FREQUENCY RESPONSE

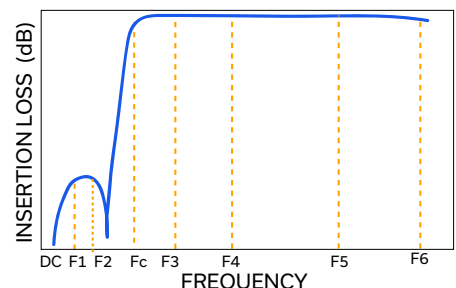



(LTCC) COAXIAL

High Pass Filter

ZHFW-K5500+

Mini-Circuits

50Ω 6.1 to 20 GHz 2.92mm Female

TYPICAL PERFORMANCE GRAPHS

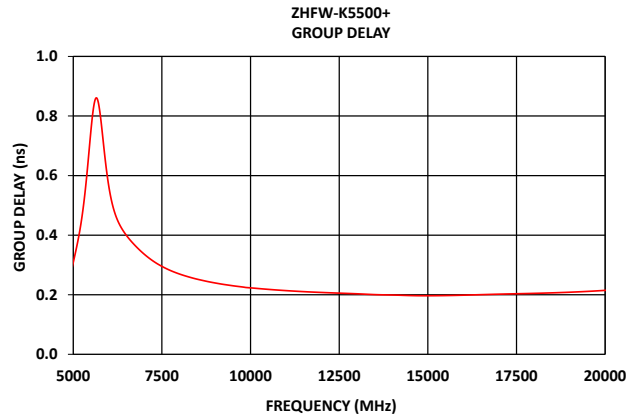
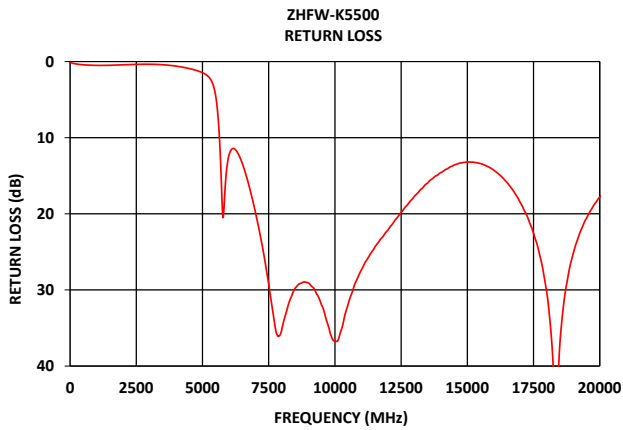
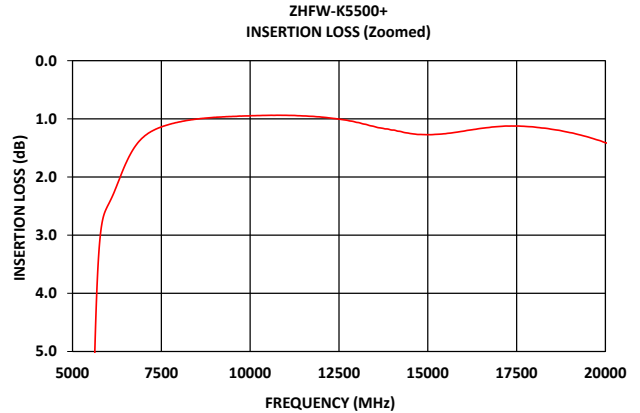
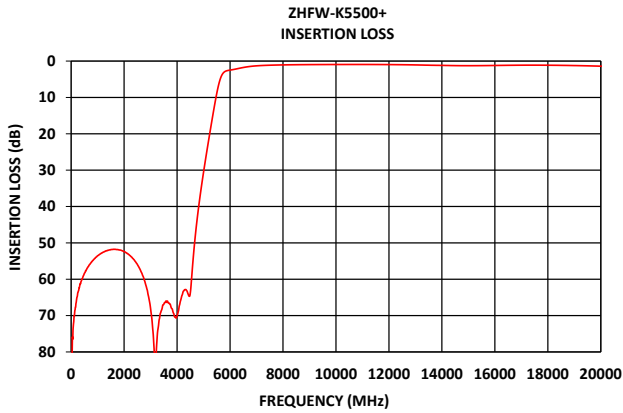



(LTCC) COAXIAL

High Pass Filter

ZHFW-K5500+

50Ω 6.1 to 20 GHz 2.92mm Female

CONNECTOR DESCRIPTION

Function	Marking on Unit	Connector
RF1 ¹	1	2.92mm Female
RF2 ¹	2	2.92mm Female

CASE STYLE DRAWING

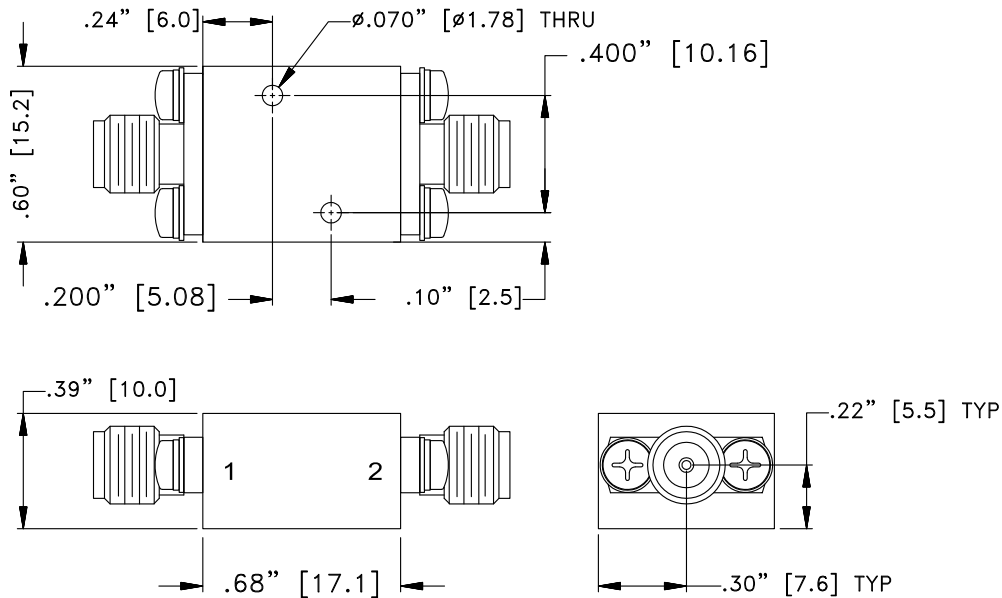

Unit weight: 24grams

Dimensions are in inches (mm). Tolerances: 2 Pl.±.050"; 3 Pl.±.015"

PRODUCT MARKING*: ZHFW-K5500+

*Marking may contain other features or characters for internal lot control.



(LTCC) COAXIAL

High Pass Filter

ZHFW-K5500+

50Ω 6.1 to 20 GHz 2.92mm Female

ADDITIONAL INFORMATION IS AVAILABLE ON OUR DASHBOARD

[CLICK HERE](#)

Performance Data & Graphs	<p>Data</p> <p>Graphs</p> <p>S-Parameter (S2P Files) Data Set (.zip file)</p>
Case Style	UK3042
RoHS Status	Compliant
Environmental Ratings	ENV124

NOTES

- A. Performance and quality attributes and conditions not expressly stated in this specification document are intended to be excluded and do not form a part of this specification document.
- B. Electrical specifications and performance data contained in this specification document are based on Mini-Circuits' applicable established test performance criteria and measurement instructions.
- C. The parts covered by this specification document are subject to Mini-Circuits' standard limited warranty and terms and conditions (collectively, "Standard Terms"); Purchasers of this part are entitled to the rights and benefits contained therein. For a full statement of the standard terms and the exclusive rights and remedies thereunder, please visit Mini-Circuits' website at www.minicircuits.com/terms/viewterm.html

