

Cavity Bandpass Filters

50Ω DC to 15 GHz

The Big Deal

- Very low insertion loss with excellent power handling
- Very fast roll-off with wide stopband
- Passbands up to 15 GHz
- Stopbands up to 20 GHz



Product Overview

Mini-Circuits' cavity filters are designed by implementing resonant structures with very high Q and are ideal for narrow-band, high-selectivity applications. These designs can provide bandwidths as narrow as 1% with very high selectivity and excellent low noise floor. Low insertion loss combined with excellent power handling makes them well-suited for transmitter and receiver front end. Advanced filter design and construction enables stopband width greater than 3x the center frequency.

Mini-Circuits' cavity filters feature a special protective assembly to prevent accidental de-tuning that would otherwise require expensive replacement or return to factory for re-tuning. Custom integrated assembly with LNA and bias tees results in greatly simplifying system integration. Precise machining allows realization of cavity filters with small form factors for applications where size is critical. Excellent repeatability across units is achieved through precise tuning and process control.

Key Features

Feature	Advantages
Low insertion loss	Low signal loss results in better SNR in receiver front end and better power delivery to antenna in transmitter
Fast roll-off	Higher selectivity results in better adjacent channel rejection and dynamic range
Wide stopband	Wide spur free band results in better receiver sensitivity
High power handling	Well suited for transmitter application
Protective assembly	Prevents accidental de-tuning of precisely tuned resonant circuit

Notes

- A. Performance and quality attributes and conditions not expressly stated in this specification document are intended to be excluded and do not form a part of this specification document.
B. Electrical specifications and performance data contained in this specification document are based on Mini-Circuit's applicable established test performance criteria and measurement instructions.
C. The parts covered by this specification document are subject to Mini-Circuits standard limited warranty and terms and conditions (collectively, "Standard Terms"); Purchasers of this part are entitled to the rights and benefits contained therein. For a full statement of the Standard Terms and the exclusive rights and remedies thereunder, please visit Mini-Circuits' website at www.minicircuits.com/MCLStore/terms.jsp



Cavity Bandpass Filter

ZVBP-4000-S+

50Ω 4000 MHz



Generic photo used for illustration purposes only
CASE STYLE: RW2359

Connectors Model
SMA-F ZVBP-4000-S+

Features

- Narrow band width
- Good VSWR, 1.3:1 typical
- High rejection
- Fast roll-off

Applications

- Fixed and mobile communication network
- Satellite communication
- Radio Astronomy

Electrical Specifications at 25°C

Parameter	F#	Frequency (MHz)	Min.	Typ.	Max.	Unit	
Pass Band	Center Frequency	-	-	4000	-	MHz	
	1 dB Bandwidth	-	-	6.0	-	MHz	
	Insertion Loss	F1	4000	-	4.5	6.5	dB
	VSWR	F1	4000	-	1.3	1.5	:1
Stop Band, Lower	Insertion Loss	DC-F2	DC - 3800	70	90	dB	
	VSWR	DC-F2	DC - 3800	-	20	-	:1
Stop Band, Upper	Insertion Loss	F3-F4	4200-6000	70	90	dB	
	VSWR	F3-F4	4200-6000	-	20	-	:1

Maximum Ratings

Operating Temperature	0°C to 50°C
Storage Temperature	-55°C to 100°C
RF Power Input	1W Max.

Permanent damage may occur if any of these limits are exceeded.

Functional Schematic

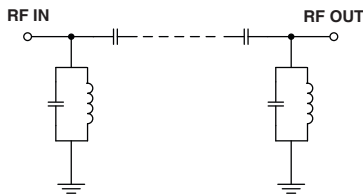

Typical Performance Data at 25°C

Frequency (MHz)	Insertion Loss (dB)	VSWR (:1)	Frequency (MHz)	Group Delay (nsec)
10	85.73	4587.09	3999.0	64.92
100	107.52	35803.34	3999.2	64.43
1000	106.17	758.06	3999.3	64.20
3800	97.81	117.19	3999.4	63.99
3900	79.08	106.81	3999.5	63.80
3950	61.02	88.35	3999.6	63.62
3985	30.78	28.39	3999.7	63.45
3990	21.31	13.95	3999.8	63.30
3997	5.59	1.42	3999.9	63.17
3999	4.40	1.07	4000.0	63.06
4000	4.22	1.13	4000.1	62.96
4001	4.19	1.12	4000.2	62.88
4003	4.63	1.12	4000.3	62.81
4011	20.71	14.69	4000.4	62.76
4016	30.32	31.00	4000.5	62.73
4050	60.31	93.56	4000.6	62.71
4100	77.71	107.79	4000.7	62.71
4200	90.99	109.73	4000.8	62.73
5000	109.33	91.25	4000.9	62.76
6000	93.30	59.12	4001.0	62.81

Typical Frequency Response

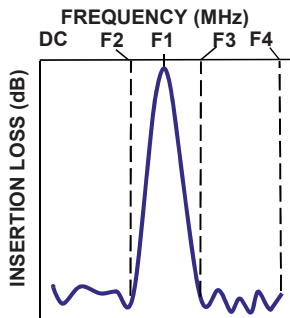

+RoHS Compliant

The +Suffix identifies RoHS Compliance. See our web site for RoHS Compliance methodologies and qualifications

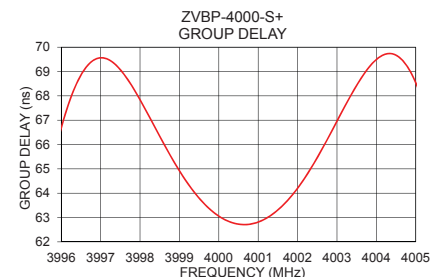
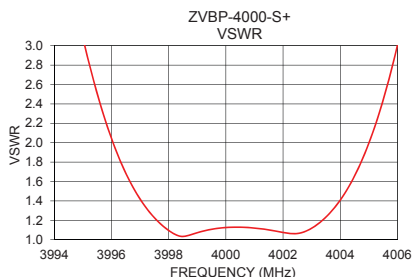
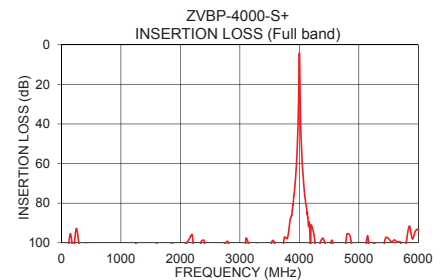
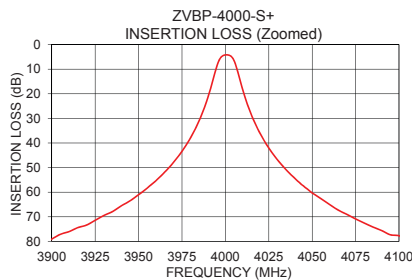

Notes

- Performance and quality attributes and conditions not expressly stated in this specification document are intended to be excluded and do not form a part of this specification document.
- Electrical specifications and performance data contained in this specification document are based on Mini-Circuit's applicable established test performance criteria and measurement instructions.
- The parts covered by this specification document are subject to Mini-Circuits standard limited warranty and terms and conditions (collectively, "Standard Terms"); Purchasers of this part are entitled to the rights and benefits contained therein. For a full statement of the Standard Terms and the exclusive rights and remedies thereunder, please visit Mini-Circuits' website at www.minicircuits.com/MCLStore/terms.jsp



Coaxial Connections

PORT-1	SMA-FEMALE
PORT-2	SMA-FEMALE

Outline Drawing

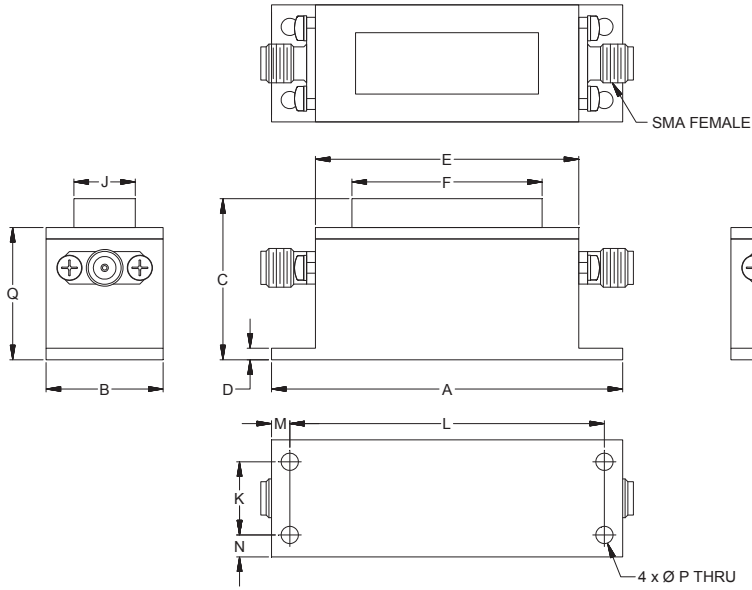

Outline Dimensions ($\frac{\text{inch}}{\text{mm}}$)

A	B	C	D	E	F	G	H	J
2.40	.80	1.10	.08	1.80	1.30	.40	.63	.42
60.96	20.32	27.96	2.00	45.72	33.02	10.16	15.96	10.67
K	L	M	N	P	Q	Wt.		
.500	2.150	.13	.15	.118	.90	grams		
12.70	54.61	3.18	3.81	3.00	22.96	54		

Note: Please refer to case style drawing for details

Notes

- A. Performance and quality attributes and conditions not expressly stated in this specification document are intended to be excluded and do not form a part of this specification document.
- B. Electrical specifications and performance data contained in this specification document are based on Mini-Circuit's applicable established test performance criteria and measurement instructions.
- C. The parts covered by this specification document are subject to Mini-Circuits standard limited warranty and terms and conditions (collectively, "Standard Terms"); Purchasers of this part are entitled to the rights and benefits contained therein. For a full statement of the Standard Terms and the exclusive rights and remedies thereunder, please visit Mini-Circuits' website at www.minicircuits.com/MCLStore/terms.jsp

