



COAXIAL

High Power Amplifier

ZVE-2W-272+ ZVE-2W-272X+

50Ω 2W 700 to 2700 MHz

THE BIG DEAL

- High Power, 2 Watt
- Wideband, 700 to 2700 MHz
- High Gain, 33 dB typ.
- High IP3, +39.5 dBm typ.
- Unconditionally stable
- Internal voltage regulated from 13 to 18VDC

APPLICATIONS

- Satellite communications
- Line-Of-Sight transmitters
- Signal generators
- Spread-spectrum communications



Generic photo used for illustration purposes only

Model No.	ZVE-2W-272+	ZVE-2W-272X+▲
Option	With heatsink	Without heatsink
Case Style	CP1978	
Connectors	SMA-Female	

+RoHS Compliant
The +Suffix identifies RoHS Compliance. See our web site for RoHS Compliance methodologies and qualifications

PRODUCT OVERVIEW

Mini-Circuits ZVE-2W-272+ is an unconditionally stable balanced class-A amplifier. This ruggedized high power amplifier is capable of delivering 2W output signals across the entire operating bandwidth, from 700 MHz to 2700 MHz. Extensive safety features enable this amplifier to survive full reflections at the RF output and to withstand an accidental reverse DC bias.

KEY FEATURES

Feature	Advantages
2W output power @ 3dB compression across 700-2700MHz bandwidth	High power output across broad frequency range supports a wide array of applications.
High Gain, 33 dB typ., good flatness ±1.2 dB typ. from 800-2300MHz	High, flat gain across entire operating bandwidth for predictable performance and signal level strength. Ideal for broadband or multi-band applications.
High IP3, +39.5 dBm typ.	Provides enhanced linearity over broad frequency range under high signal conditions.
Internal open and short protection circuitry	Antenna mismatches or damaged output cables will not cause the damage of amplifier
Unconditionally stable	No risk of damage to other components from impedance mismatch or internal oscillations. Eliminate the need for any compensating network.





COAXIAL

High Power Amplifier

ZVE-2W-272+ ZVE-2W-272X+

ELECTRICAL SPECIFICATIONS¹ AT 25°C

Parameter	Condition (MHz)	ZVE-2W-272+ ZVE-2W-272X+ [▲]			Units
		Min.	Typ.	Max.	
Frequency Range		700		2700	MHz
Gain	700 - 2700	27	33	41	dB
Gain Flatness	700 - 800	—	±3.0	—	dB
	800 - 2700	—	±1.6	—	
Input VSWR	700 - 2700	—	1.8	—	:1
Output VSWR	700 - 2700	—	1.25	—	:1
Reverse Isolation	700 - 2700	—	65	—	dB
Output Power at 1dB Compression	700 - 800	28	30	—	dBm
	800 - 2700	29	32	—	
Output Power at 3 dB Compression	700 - 800	30	32	—	dBm
	800 - 2700	31	34	—	
Output IP3 ²	700 - 800	—	38	—	dBm
	800 - 2700	—	40	—	
Noise Figure	700 - 800	—	9	—	dB
	800 - 2700	—	6	—	
Device Operating Voltage (Vcc)		13	15	18	V
Device Operating Current		—	600	800	mA
Device Current Variation vs. Temperature		—	0.15	—	mA/°C
Device Current Variation vs. Voltage		—	32.6	—	mA/V
Thermal Resistance, junction-to-case		—	23.5	—	°C/W

1. All specifications are for a single input CW Signal. At nominal output load, 15V nominal supply voltage. An open or short load is not recommended, potentially can cause damage.

2. Measured with 2 tones, 1 MHz apart, +10dBm/tone.

[▲] Heat sink not included. Alternative heat sinking and heat removal must be provided the user to limit maximum base-plate temperature to 85°C, in order to ensure proper performance. For reference, this requires thermal resistance of user's external heat sink to be 4°C/W max.

MAXIMUM RATINGS

Parameter	Ratings
Operating Temperature (Base Plate)	-40°C to 85°C
Storage Temperature	-55°C to 125°C
Base Plate Temperature	85°C
DC Voltage	+18V
Operating Current at 15V	1.5A
Input RF Power (no damage)	+15 dBm

Permanent damage may occur if any of these limits are exceeded.





COAXIAL

High Power Amplifier

ZVE-2W-272+ ZVE-2W-272X+

OUTLINE DRAWING FOR MODELS WITH HEATSINK (ZVE-2W-272+)

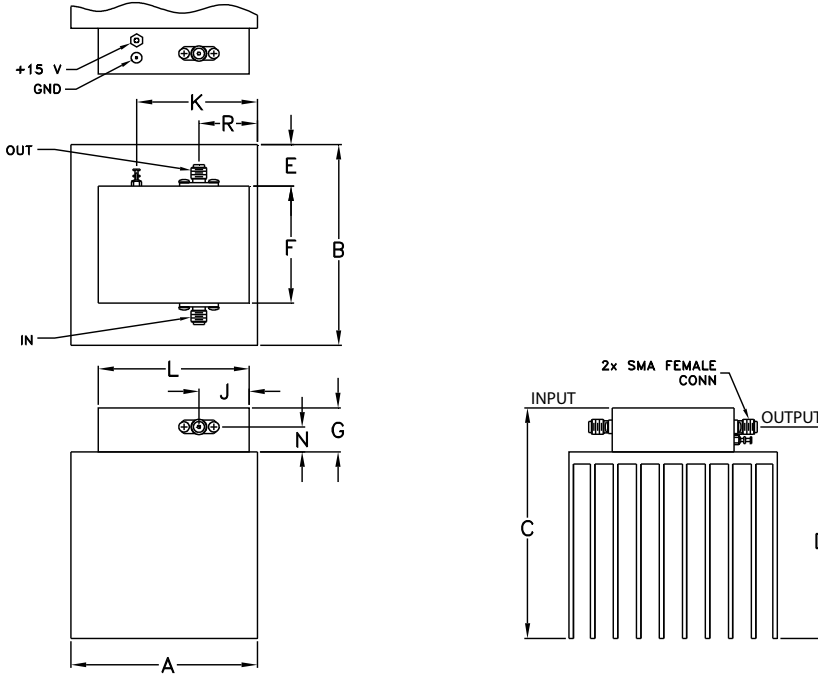

MOUNTING INFORMATION FOR MODELS WITHOUT HEATSINK (ZVE-2W-272X+)

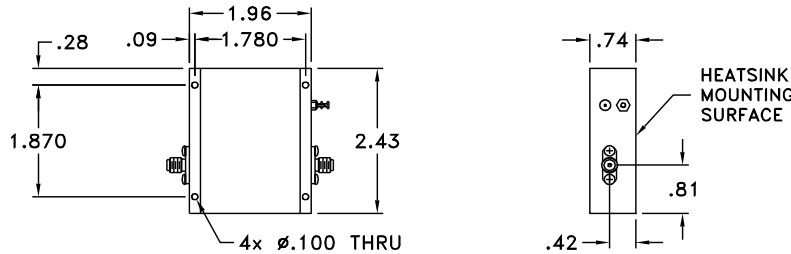

OUTLINE DIMENSIONS (inch/mm)

A	B	C	D	E	F	G	H	J	K
3.00	3.36	3.86	3.54	.69	1.96	.74	--	.81	1.94
76.20	85.34	98.04	89.92	17.53	49.78	18.80	--	20.57	49.28
L	M	N	P	Q	R	S	T	wt	
2.43	--	.42	--	--	.94	--	--	grams*	
61.72	--	10.67	--	--	23.88	--	--	530.0	

*120 grams without heatsink



COAXIAL

High Power Amplifier

ZVE-2W-272+ ZVE-2W-272X+

TYPICAL PERFORMANCE DATA/CURVES

Frequency (MHz)	Gain (dB)	Directivity (dB)	VSWR (:1)		Pout at 1 dB Compr. (dBm)	Pout at 3 dB Compr. (dBm)	Noise Figure (dB)	OIP3 (dBm)
	15V	15V	IN	OUT	15V	15V	15V	15V
700	32.91	38.25	1.85	1.54	30.98	32.04	8.60	39.27
800	35.69	37.12	1.78	1.42	31.33	32.23	6.43	40.67
900	36.89	51.26	1.68	1.34	32.62	33.11	4.88	42.06
1000	36.93	39.44	1.56	1.31	32.26	33.00	4.20	42.75
1200	36.11	36.89	1.25	1.36	32.61	33.09	3.39	43.66
1400	35.71	39.57	1.16	1.36	32.60	33.12	3.06	43.28
1600	35.45	35.04	1.41	1.30	32.71	33.23	3.21	43.43
1800	35.30	42.71	1.65	1.25	32.81	33.31	3.19	43.64
2000	35.31	27.54	1.78	1.19	32.96	33.42	3.17	43.68
2200	35.40	33.73	1.74	1.14	33.14	33.53	3.18	43.22
2300	35.38	37.50	1.65	1.16	33.10	33.64	3.35	43.17
2400	35.45	44.54	1.56	1.22	33.16	33.55	3.04	42.83
2500	35.51	31.11	1.46	1.27	33.15	33.72	3.56	42.52

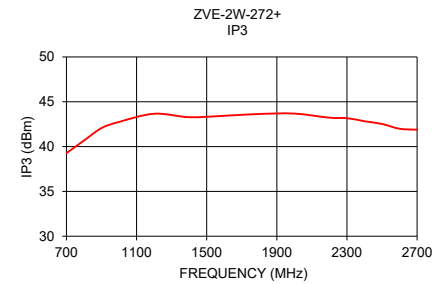
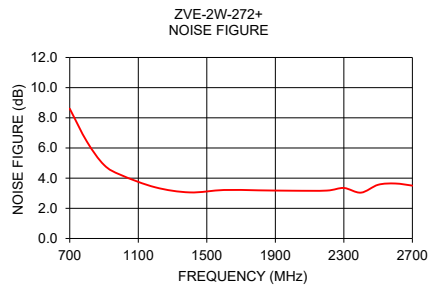
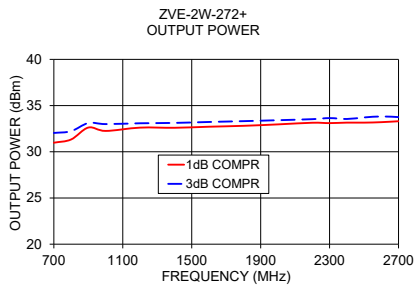
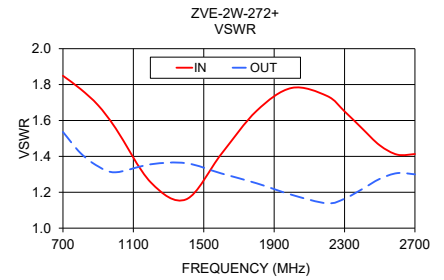
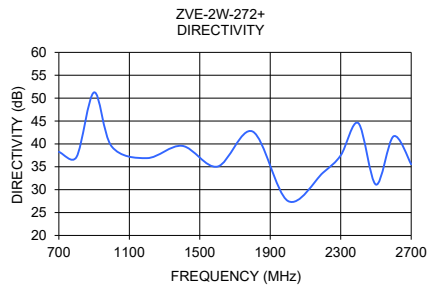
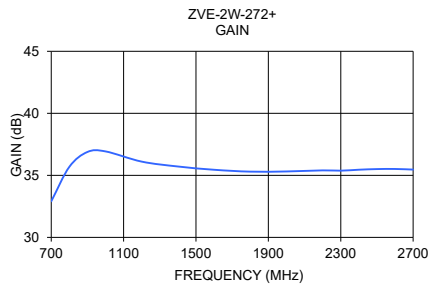

- NOTES**
- A. Performance and quality attributes and conditions not expressly stated in this specification document are intended to be excluded and do not form a part of this specification document.
 - B. Electrical specifications and performance data contained in this specification document are based on Mini-Circuit's applicable established test performance criteria and measurement instructions.
 - C. The parts covered by this specification document are subject to Mini-Circuits standard limited warranty and terms and conditions (collectively, "Standard Terms"); Purchasers of this part are entitled to the rights and benefits contained therein. For a full statement of the standard. Terms and the exclusive rights and remedies thereunder, please visit Mini-Circuits' website at www.minicircuits.com/terms/viewterm.html

