



SUPER ULTRA

Wideband Amplifier

ZVE-403-K+ ZVE-403X-K+

50Ω 26 to 40 GHz

THE BIG DEAL

- Wideband, 26 to 40 GHz
- High output IP3, 28 dBm typ.
- Medium power output, +21 dBm
- High gain, 22±2 dB typ.

APPLICATIONS

- Radar and military
- Test instrumentation
- Satellite repeaters
- Communication

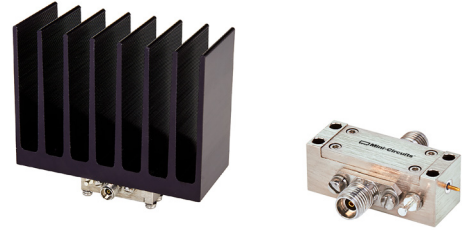

Generic photo used for illustration purposes only

Model No.	ZVE-403-K+	ZVE-2W-272X+▲
Option	With heatsink	Without heatsink
Case Style	AV1280-2	
Connectors	2.92mm	

+RoHS Compliant
 The +Suffix identifies RoHS Compliance. See our web site for RoHS Compliance methodologies and qualifications

PRODUCT OVERVIEW

Mini-Circuits' ZVE-403-K+ is a Class-A, four-stage, unconditionally stable amplifier providing flat gain over an extremely wide frequency range from 26 to 40 GHz. This model is capable of delivering up to 0.125W output power at P3dB with high output IP3 supporting a wide range of sensitive, high-dynamic range receiver applications and many systems where high performance over wideband is needed. It operates on a +12V supply and features built-in safety features including protection against reverse bias and immunity to accidental (less than 2 minutes) open or short loads. The amplifier comes in a rugged, compact case (1.2 x 0.46 x 0.45") with K-type (2.92mm) connectors and an optional heat sink for efficient cooling.

KEY FEATURES

Feature	Advantages
Ultra-wideband, 26 to 40 GHz Able to work from 25 to 42 GHz	Enables a single amplifier to be used in a wide range of applications.
Excellent gain flatness, ±2.0 dB across full frequency range	Provides consistent performance across its operating frequency, minimizing the need for external equalizing networks in wideband applications.
High gain, 22 dB typ.	Reduces the number of gain stages, lowering component count and overall system cost.
Class A Amplifier	Provides good linearity with low signal distortion.
High Output IP3: +28 dBm typ.	The high IP3 results in high SFDR (Spurious Free Dynamic Range) and makes the ZVE-403-K+ ideal for use in high performance receiver front end (RFE) as it gives the user the advantages in a real world of multi-tone interference.
Rugged design	Built-in protection against reverse bias and accidental open and short loads provides added reliability for demanding operating conditions.





SUPER ULTRA

Wideband Amplifier

ZVE-403-K+ ZVE-403X-K+

Mini-Circuits

ELECTRICAL SPECIFICATIONS AT 25°C

Parameter	Condition (GHz)	ZVE-403-K+ ZVE-403X-K+ [▲]			Units
		Min.	Typ.	Max.	
Frequency Range		26		40	GHz
Gain	26 - 40	15.5	22	—	dB
Gain Flatness	26 - 40	—	±2.0	±3.0	dB
Input VSWR	26 - 40	—	2.0	3.0	:1
Output VSWR	26 - 40	—	2.0	3.0	:1
Output Power at 1dB Compression	26 - 40	14.5	19	—	dBm
Output Power at 3 dB Compression	26 - 40	16.5	21	—	dBm
Noise Figure	26 - 40	—	9	—	dB
DC Supply Voltage		11	12 ¹	14	V
Supply Current		—	300	400	mA

1. Recommended Operating Voltage.

[▲] Heat sink not included. Alternative heat sinking and heat removal must be provided by the user to limit maximum base-plate temperature to 85°C, in order to ensure proper performance. For reference, this requires thermal resistance of user's external heat sink to be 5.0°C/W max.

MAXIMUM RATINGS

Parameter	Ratings
Operating Temperature	ZVE-403-K+ -40°C to 60°C ambient
	ZVE-403X-K+ -40°C to 85°C base plate temp.
Storage Temperature	-65°C to 150°C
DC Voltage	+14V
CW Input RF Power (no damage)	+17 dBm

Permanent damage may occur if any of these limits are exceeded.





SUPER ULTRA

Wideband Amplifier

ZVE-403-K+ ZVE-403X-K+

OUTLINE DRAWING FOR MODELS WITH HEATSINK (ZVE-403-K+)

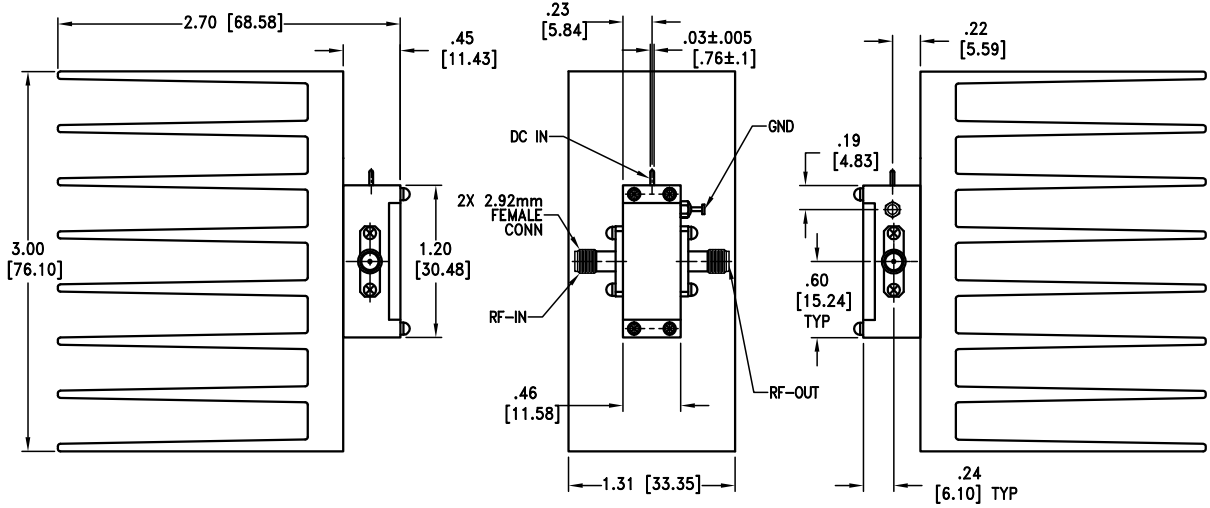

MOUNTING INFORMATION FOR MODELS WITHOUT HEATSINK (ZVE-403X-K+)

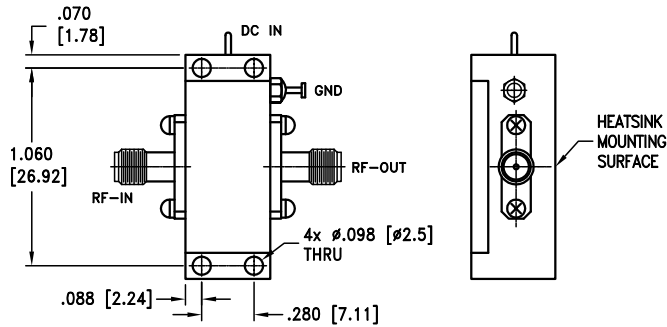

Weight: 150 grams; Weight without heatsink: 17 grams

Dimensions are in inches [mm]





SUPER ULTRA

Wideband Amplifier

ZVE-403-K+ ZVE-403X-K+

TYPICAL PERFORMANCE DATA/CURVES

Frequency (MHz)	Gain (dB)	Directivity (dB)	VSWR (:1)		Pout at 1 dB Compr. (dBm)	Pout at 3 dB Compr. (dBm)	Noise Figure (dB)	OIP3 (dBm)
	12V	12V	IN	OUT	12V	12V	12V	12V
26000	24.79	24.93	1.80	1.39	20.08	21.17	7.99	27.46
26500	24.76	25.53	1.63	1.40	20.17	21.25	7.62	27.40
27000	24.65	26.11	1.47	1.44	19.87	20.95	7.86	27.59
27500	24.44	26.55	1.34	1.47	19.72	20.89	7.79	27.74
28000	24.12	27.09	1.24	1.52	19.88	21.12	7.67	27.30
28500	23.71	27.54	1.19	1.56	19.67	20.97	7.85	27.73
29000	23.26	27.79	1.20	1.59	19.42	20.71	7.97	28.03
29500	22.80	28.49	1.23	1.61	19.41	20.64	7.75	28.06
30000	22.54	31.56	1.29	1.65	19.13	20.42	7.77	27.79
30500	22.36	33.24	1.38	1.72	19.10	20.37	8.12	28.08
31000	22.17	33.23	1.44	1.77	19.31	20.64	8.06	27.92
32000	21.96	34.08	1.52	1.82	18.89	20.16	8.05	27.86
33000	21.75	34.13	1.58	1.75	18.82	20.12	8.65	27.75
34000	21.78	33.72	1.61	1.65	18.85	20.20	8.39	27.11
35000	22.04	32.55	1.61	1.55	18.72	20.06	8.48	26.96
36000	22.28	31.00	1.62	1.48	18.81	20.09	7.87	26.67
37000	22.34	31.22	1.65	1.44	18.84	19.98	8.07	26.23
38000	22.21	28.68	1.69	1.46	18.81	19.90	7.95	25.68
39000	21.75	28.77	1.75	1.62	18.73	19.75	8.01	25.61
40000	21.25	29.21	1.79	1.95	18.34	19.33	7.97	25.34

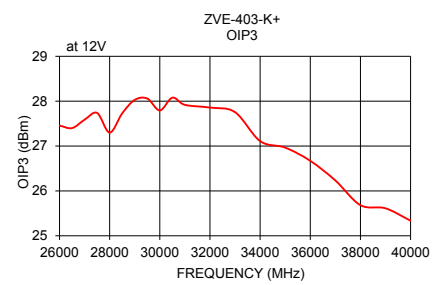
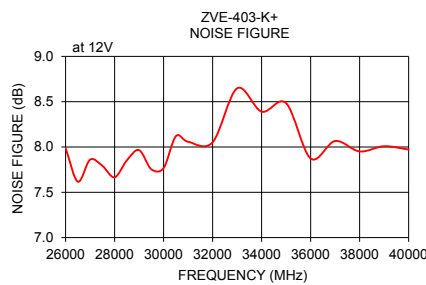
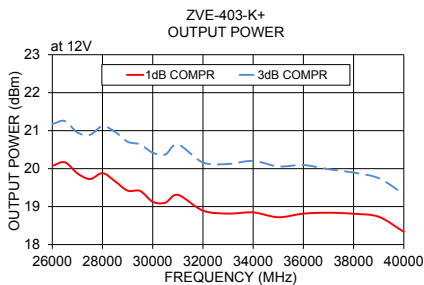
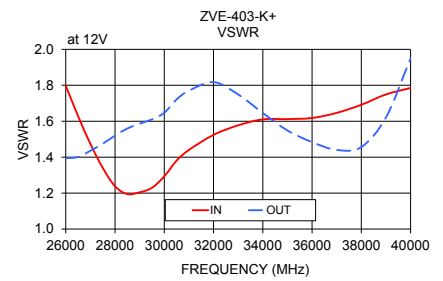
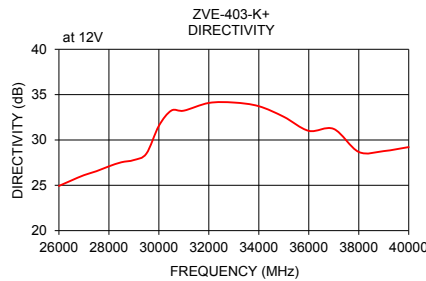
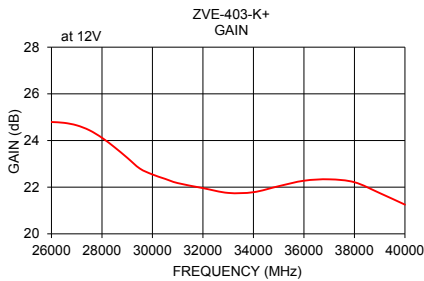

- NOTES**
- A. Performance and quality attributes and conditions not expressly stated in this specification document are intended to be excluded and do not form a part of this specification document.
 - B. Electrical specifications and performance data contained in this specification document are based on Mini-Circuit's applicable established test performance criteria and measurement instructions.
 - C. The parts covered by this specification document are subject to Mini-Circuits standard limited warranty and terms and conditions (collectively, "Standard Terms"); Purchasers of this part are entitled to the rights and benefits contained therein. For a full statement of the standard. Terms and the exclusive rights and remedies thereunder, please visit Mini-Circuits' website at www.minicircuits.com/terms/viewterm.html

