



MEDIUM POWER, HIGH GAIN

# Wideband Amplifier

## ZVE-453HP+ ZVE-453HPX+

50Ω 18 to 45 GHz

### THE BIG DEAL

- High gain 39 dB typ. over the entire operating band
- Excellent gain flatness,  $\pm 2.5$  dB typ.
- Saturated output power = +31 dBm typ.
- Adjustable DC voltage, +10 to +15 V



Generic photo used for illustration purposes only

### APPLICATIONS

- Wideband Test and Instrumentation
- 5G mmW
- SATCOM
- Wireless Infrastructure

<b>Model No.</b>	ZVE-453HP+	ZVE-453HPX+
<b>Option</b>	With heatsink & fan	Without heatsink & fan
<b>Case Style</b>	VN3071-4	
<b>Connectors</b>	2.4mm Female	

#### +RoHS Compliant

The +Suffix identifies RoHS Compliance. See our web site for RoHS Compliance methodologies and qualifications

### PRODUCT OVERVIEW

Mini-Circuits' ZVE-453HP+ is a coaxial, 1 Watt wideband high gain amplifier, operating from 18 to 45 GHz. This model operates over a single positive supply range of +10 to +15 V, allowing users to choose their desired operating voltage. Internal DC-DC conversion circuitry maintains constant efficiency over the full input voltage range. The amplifier incorporates several DC-protection features, such as over-voltage, reverse voltage and in-rush current, that protect the amplifier from damage if mishandled during operation. The wideband operation combined with high output power makes this amplifier an ideal choice for testing and instrumentation applications.

### KEY FEATURES

Feature	Advantages
Wide-band amplifier, 18 to 45 GHz	A single amplifier serves the need for applications including 5G bands (24 to 39 GHz), SATCOM, Test & Instrumentation, etc.
Integrated fan assembly	Model ZVE-453HP+ utilizes two integrated fans, keeping the amplifier cool to the touch during normal operation at room temperature
High gain Low VSWR Medium RF power	The amplifier provides 39 dB (typ.) of gain over the entire operating band, and is capable of delivering over 1 Watt of RF power
Adjustable DC Supply Voltage	The device is capable of operating from +10 to +15 V with consistent DC power consumption
DC Protection – Over-voltage Reverse voltage In-rush Current	The internal DC circuitry allows the amplifier to be protected from external mishandling, that could lead to catastrophic failures in the field

REV. A  
ECO-012828  
ZVE-453HP+  
MCL NY  
220414





MEDIUM POWER, HIGH GAIN

# Wideband Amplifier

# ZVE-453HP+ ZVE-453HPX+

Mini-Circuits

## ELECTRICAL SPECIFICATIONS AT 25 °C BASEPLATE

Parameter	Condition (MHz)	ZVE-453HP+ <sup>3</sup> ZVE-453HPX+ <sup>4</sup>			Units
		Min.	Typ.	Max.	
Frequency Range		18000		45000	MHz
Gain	18000-30000	33.0	37		dB
	30000-45000	35.0	40		
Output Power at 1dB compression	18000 - 26000	25.0	29.0		dBm
	26000 - 40000	29.0	30.5		
	40000 - 45000	25.5	28.5		
Saturated Output Power	18000 - 26000	28.0	30.5		dBm
	26000 - 40000	30.5	32.0		
	40000 - 45000	27.5	30.0		
Output IP3	18000 - 45000		41		dBm
Input VSWR	18000 - 45000		1.5	2.0	:1
Output VSWR <sup>1</sup>	18000 - 45000		1.5	2.0	:1
Operating DC Voltage		+10	—	+15	V
Device Operating Current at +15 V (ZVE-453HPX+ / ZVE-453HP+)			900 <sup>4</sup> / 1100 <sup>3</sup>	1600 <sup>4</sup> / 1800 <sup>3</sup>	mA
Device Operating Power at +15 V			19 <sup>2</sup>		W

1. Open and short-circuit loads are not recommended at the amplifier output. Ensure proper 50 Ohm load before turning the amplifier "ON".
2. Device operating power is based on current when amplifier is in saturation.
3. For units with heatsink, limit ambient temperature to 50 °C.
4. For units without heatsink, limit the maximum baseplate temperature to 60 °C.

## MAXIMUM RATINGS<sup>6</sup>

Parameter	Ratings
Operating Temperature	ZVE-453HP+ -40 °C to +50 °C Ambient ZVE-453HPX+ -40 °C to +60 °C Baseplate
Storage Temperature	-40 °C to +85 °C
Total Power Dissipation	20 W
RF Input Power <sup>5</sup> (CW)	+2 dBm
DC Operating Voltage	+16 V

5. Specified under matched load to 50 ohms.
6. Continuous operation is not recommended at these extremes. Permanent damage may occur if any of these limits are exceeded.





MEDIUM POWER, HIGH GAIN

# Wideband Amplifier

## ZVE-453HP+ ZVE-453HPX+

### OUTLINE DRAWING FOR MODELS WITH HEATSINK & FAN (ZVE-453HP+)

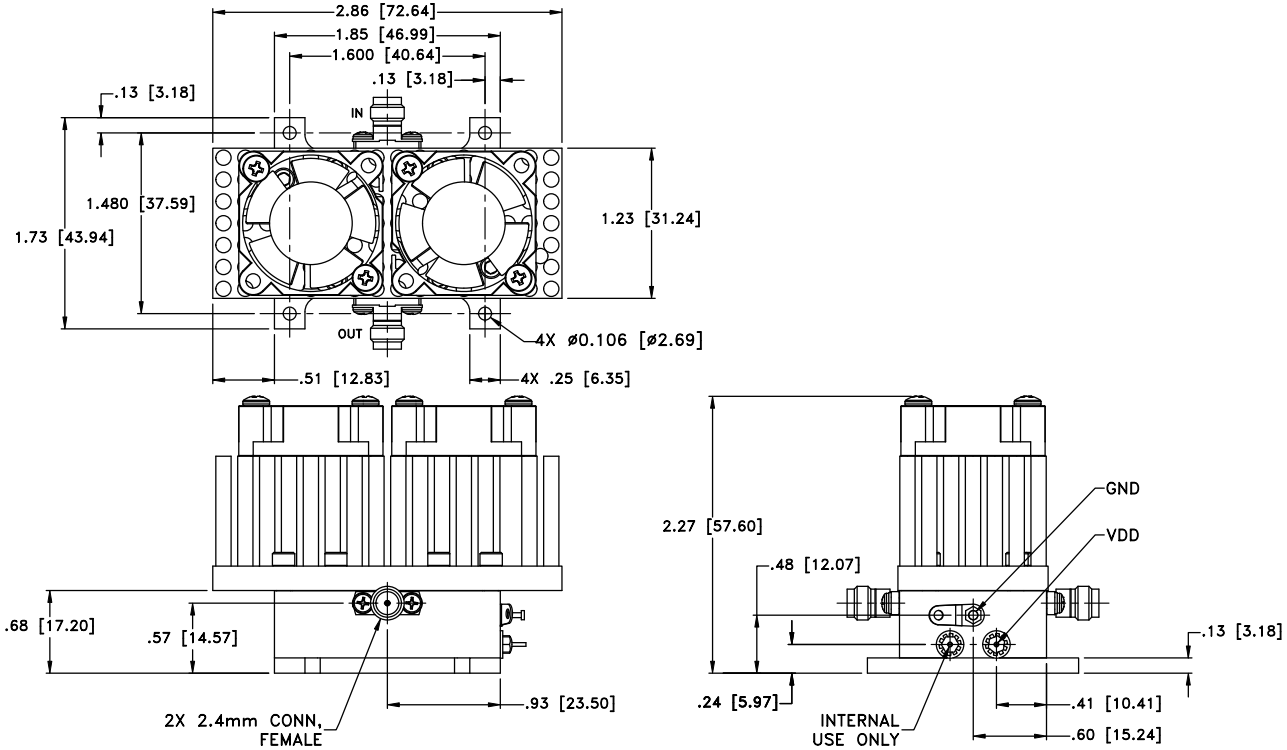

### MOUNTING INFORMATION FOR MODELS WITHOUT HEATSINK & FAN (ZVE-453HPX+)

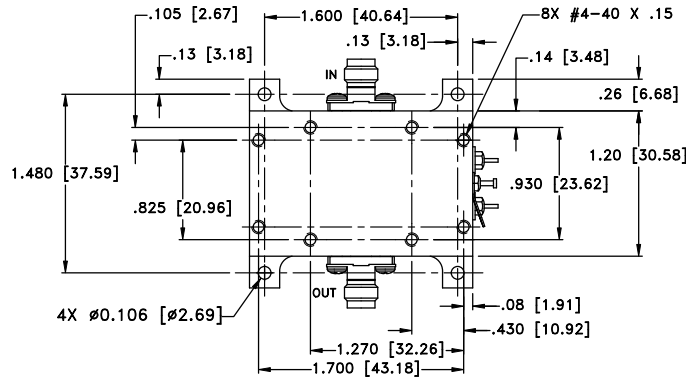

WT. GRAMS 160 grams; WITHOUT HEATSINK GRAMS 60 grams  
Dimensions are in inches [mm]. Tolerances: 2 Pl. ±.03; 3 Pl. ±.015





MEDIUM POWER, HIGH GAIN

# Wideband Amplifier

# ZVE-453HP+ ZVE-453HPX+

## TYPICAL PERFORMANCE DATA/CURVES

Frequency (MHz)	Gain (dB)	Directivity (dB)	VSWR (:1)		Pout @ 1 dB Compression (dBm)	Pout @ Saturation (dBm)	Output IP3 (dBm)
			IN	OUT			
18000	38.95	56.99	1.56	1.30	26.89	29.23	35.57
21000	38.74	53.83	1.27	1.17	30.31	31.04	40.71
24000	36.85	53.88	1.10	1.31	30.28	31.30	40.20
27000	36.80	46.04	1.23	1.21	31.10	32.47	45.85
30000	39.08	46.57	1.04	1.26	30.81	32.64	41.07
33000	39.66	51.30	1.05	1.22	30.64	32.37	41.05
36000	41.58	42.67	1.43	1.43	30.69	31.84	40.16
39000	39.83	50.34	1.33	1.67	30.35	31.42	38.76
42000	40.67	39.41	1.58	1.61	29.23	30.87	39.23
45000	40.85	38.74	1.85	1.40	27.18	29.16	37.82

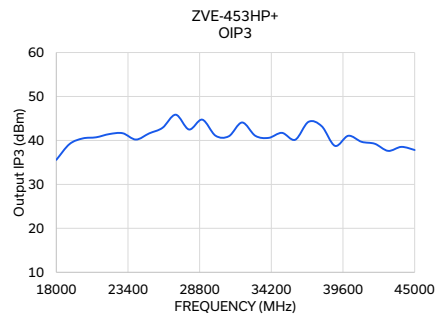
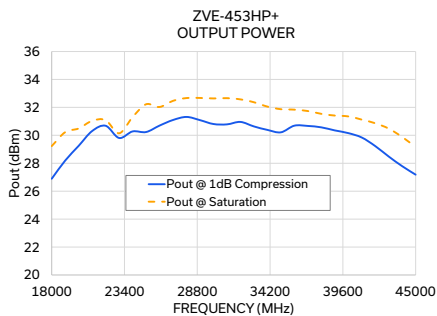
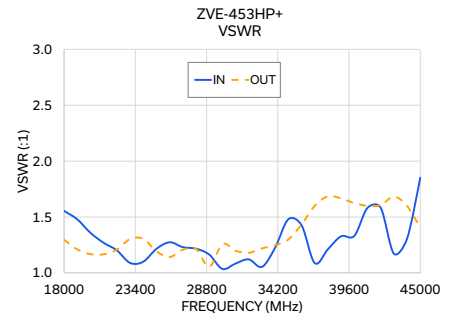
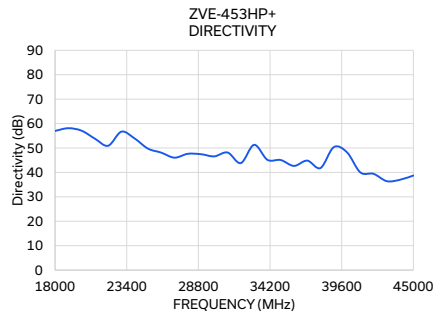
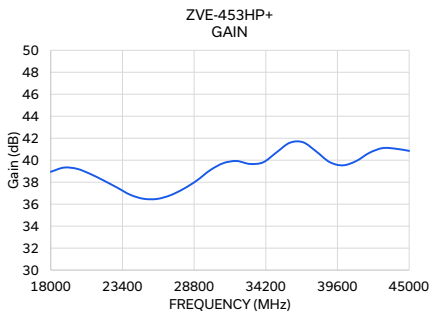

- NOTES**
- A. Performance and quality attributes and conditions not expressly stated in this specification document are intended to be excluded and do not form a part of this specification document.
  - B. Electrical specifications and performance data contained in this specification document are based on Mini-Circuit's applicable established test performance criteria and measurement instructions.
  - C. The parts covered by this specification document are subject to Mini-Circuits standard limited warranty and terms and conditions (collectively, "Standard Terms"); Purchasers of this part are entitled to the rights and benefits contained therein. For a full statement of the standard. Terms and the exclusive rights and remedies thereunder, please visit Mini-Circuits' website at [www.minicircuits.com/MCLStore/terms.jsp](http://www.minicircuits.com/MCLStore/terms.jsp)

